



US00D467353S

(12) **United States Design Patent**
Panek et al.

(10) **Patent No.:** **US D467,353 S**

(45) **Date of Patent:** **** Dec. 17, 2002**

(54) **ARBOR**

D361,391 S * 8/1995 Goldman D25/100

(75) Inventors: **Dennis R. Panek**, San Diego, CA (US);
Jane G. Panek, San Diego, CA (US);
Connie Humphrey, San Diego, CA
(US); **Michael D. Graves**, San Diego,
CA (US)

* cited by examiner

Primary Examiner—Doris Clark
(74) *Attorney, Agent, or Firm*—Eric K. Satermo

(73) Assignee: **Wedding Arbors, Inc.**, San Diego, CA
(US)

(57) **CLAIM**

The ornamental design of an arbor, as shown and described.

(**) Term: **14 Years**

DESCRIPTION

(21) Appl. No.: **29/154,435**

FIG. 1 is perspective view of an arbor in accordance with the present invention;

(22) Filed: **Jan. 21, 2002**

FIG. 2 is a front view of an arbor;

(51) **LOC (7) Cl.** **08-99**

FIG. 3 is a back view of an arbor;

(52) **U.S. Cl.** **D25/100**

FIG. 4 is a right side view of an arbor;

(58) **Field of Search** D25/100; 47/44,
47/47

FIG. 5 is a left side view of an arbor; and,

FIG. 6 is a top view of an arbor.

(56) **References Cited**

U.S. PATENT DOCUMENTS

D154,136 S * 6/1949 Morris D25/100

1 Claim, 5 Drawing Sheets

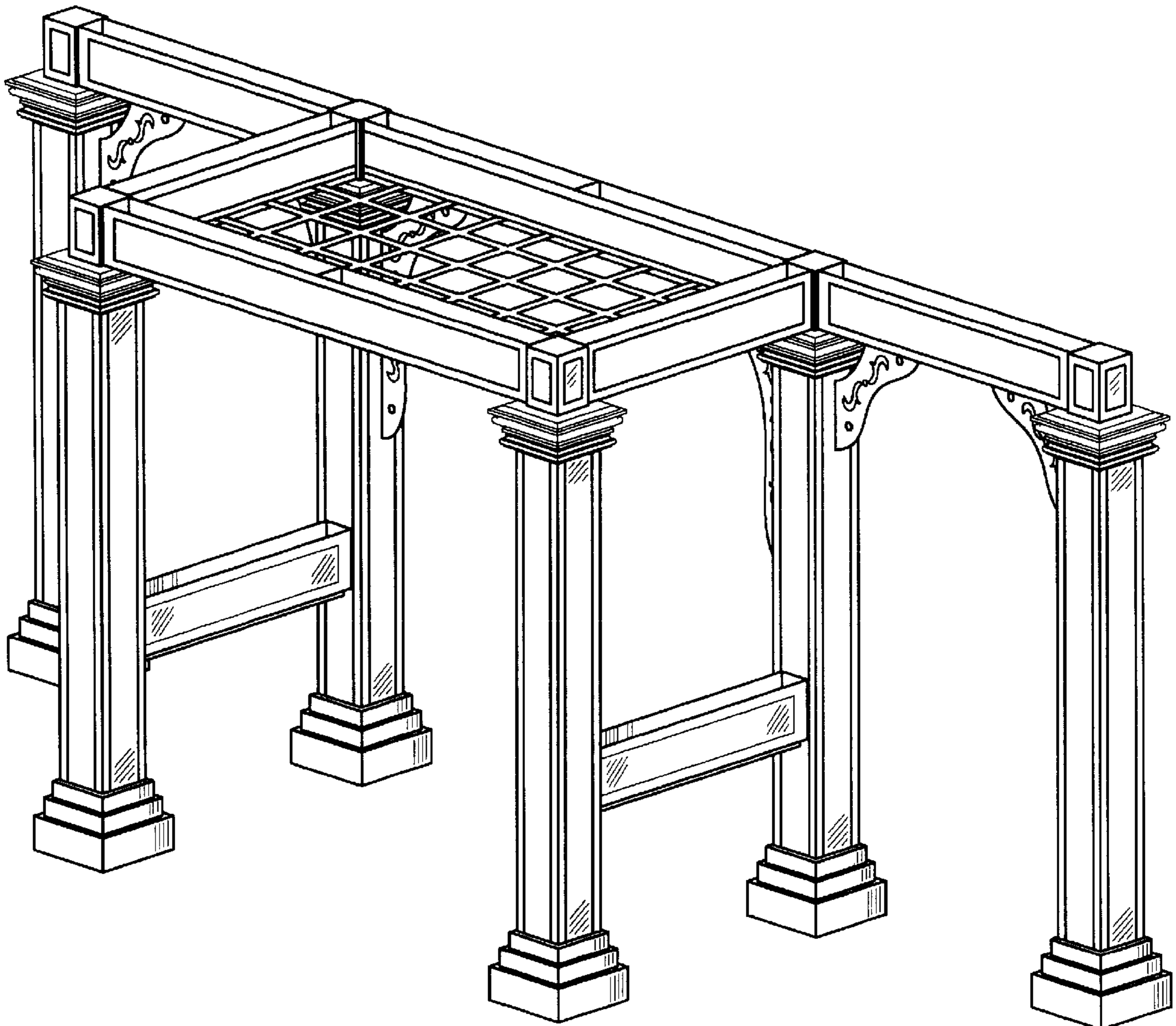

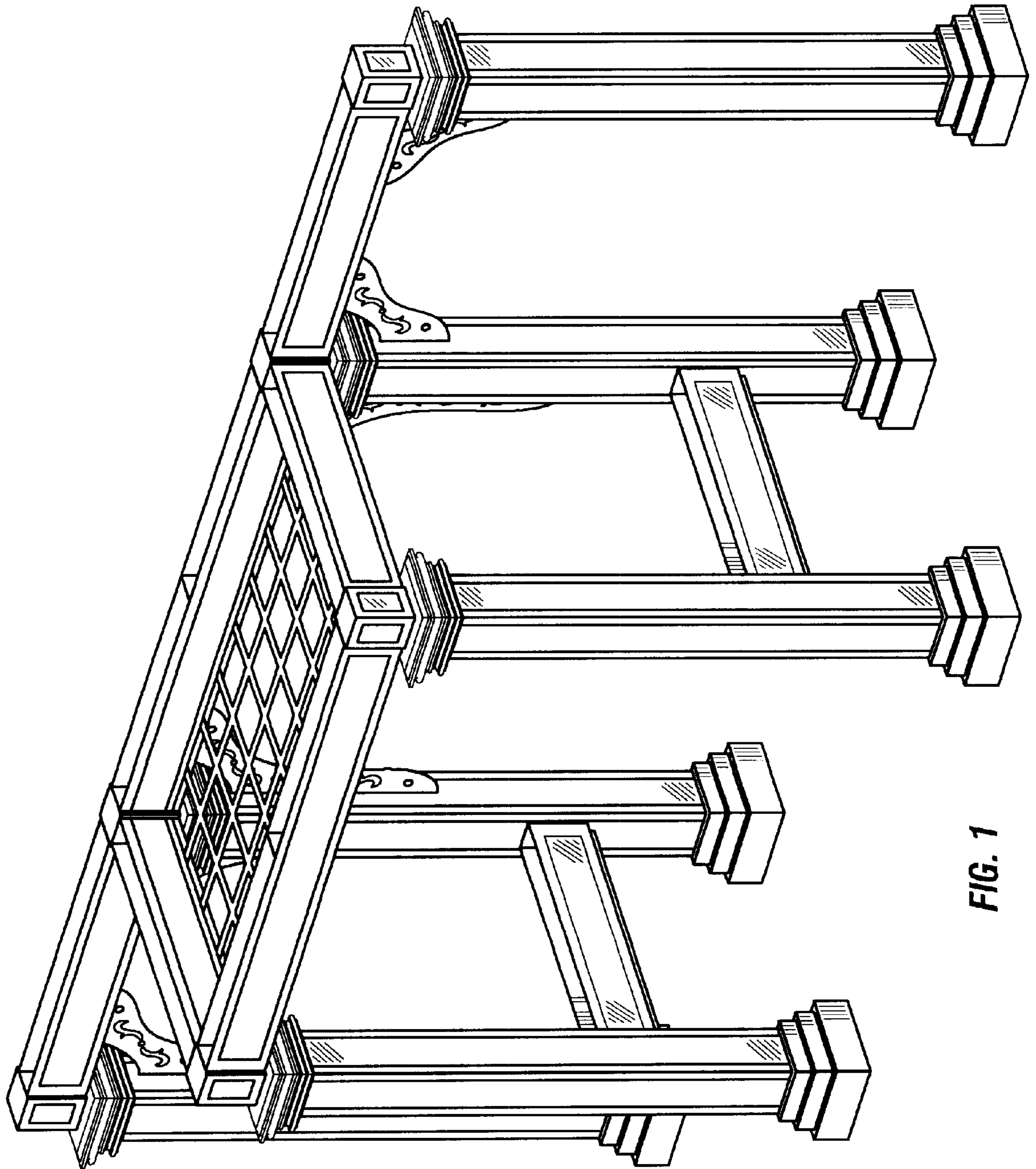

FIG. 1

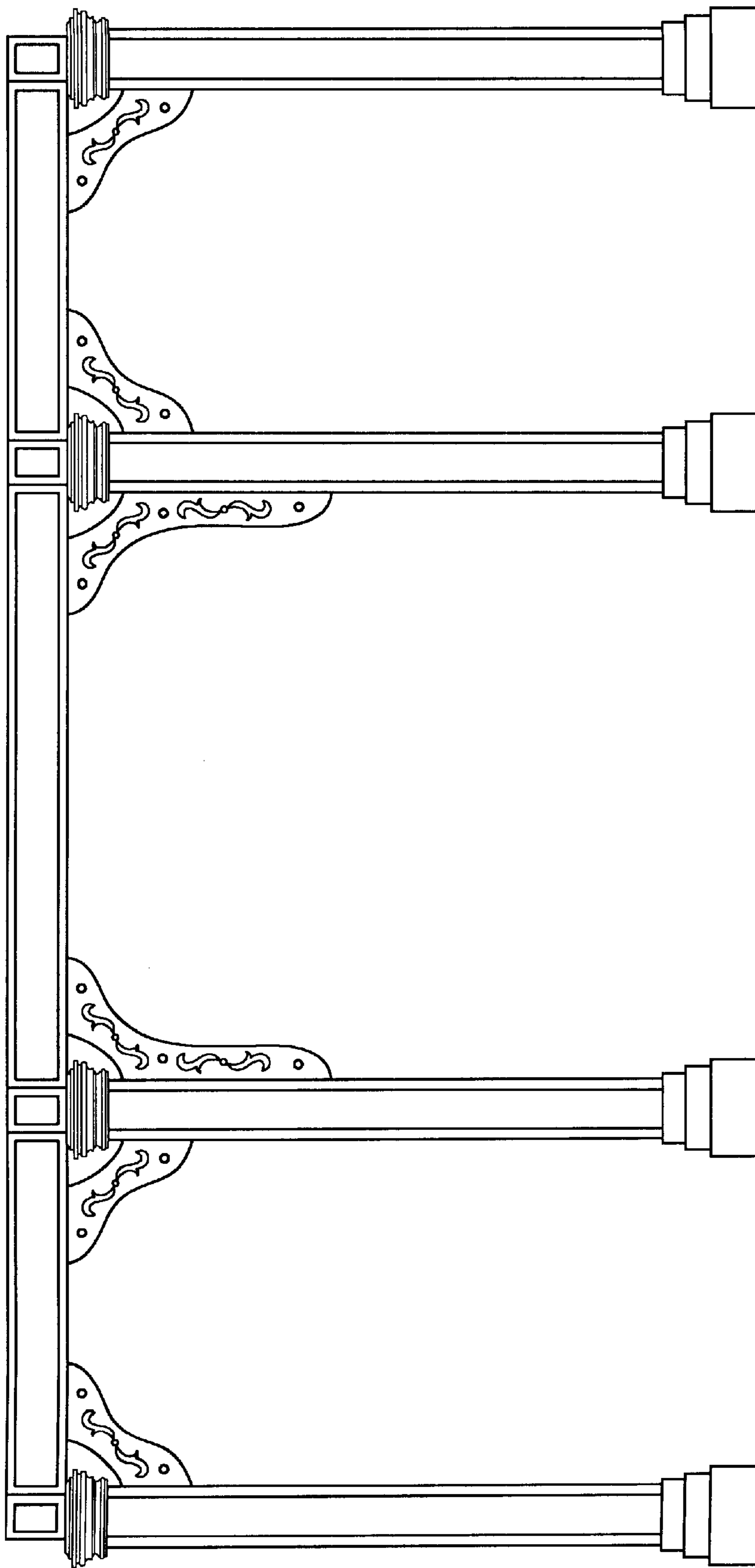

FIG. 2

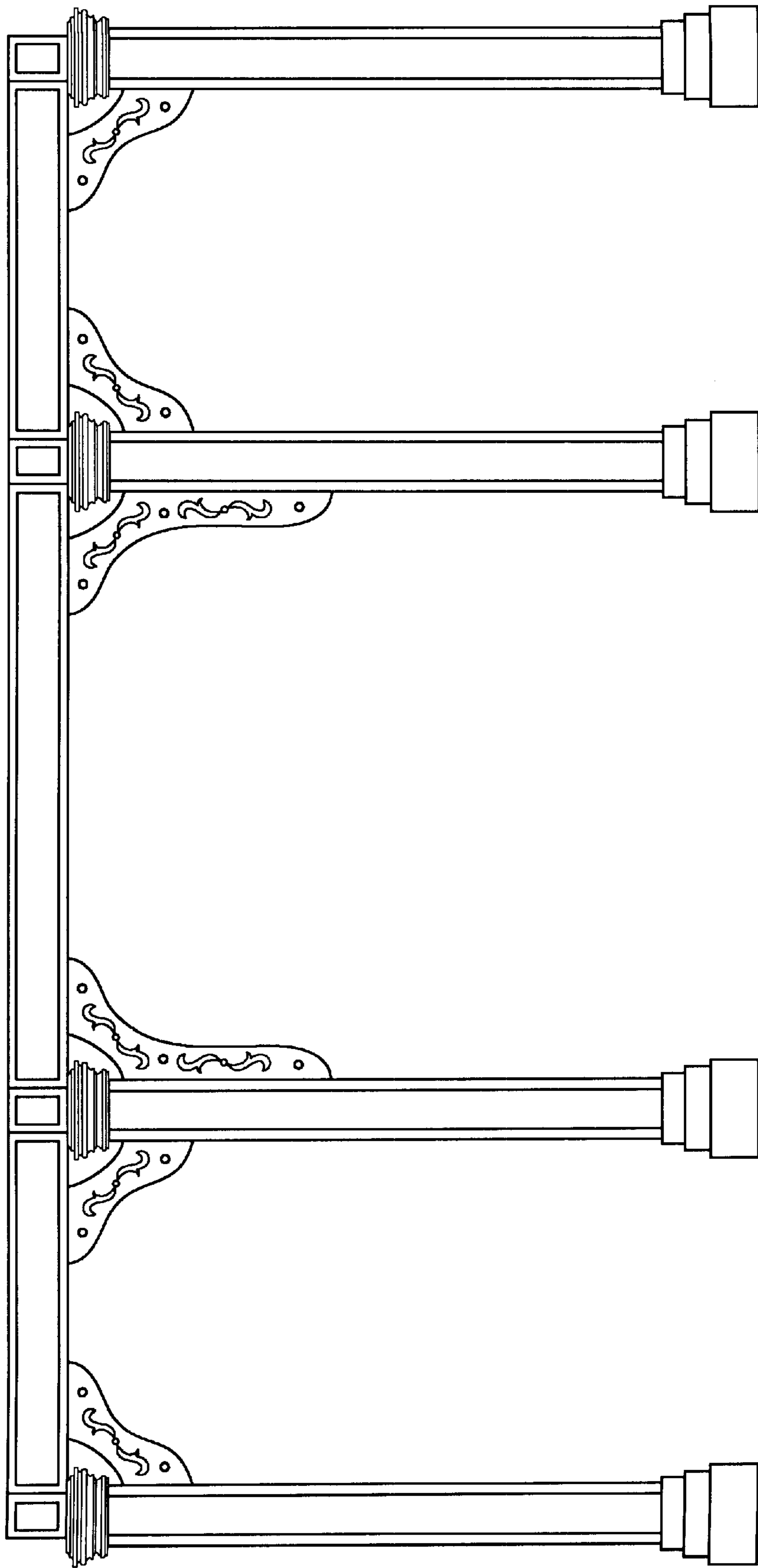

FIG. 3

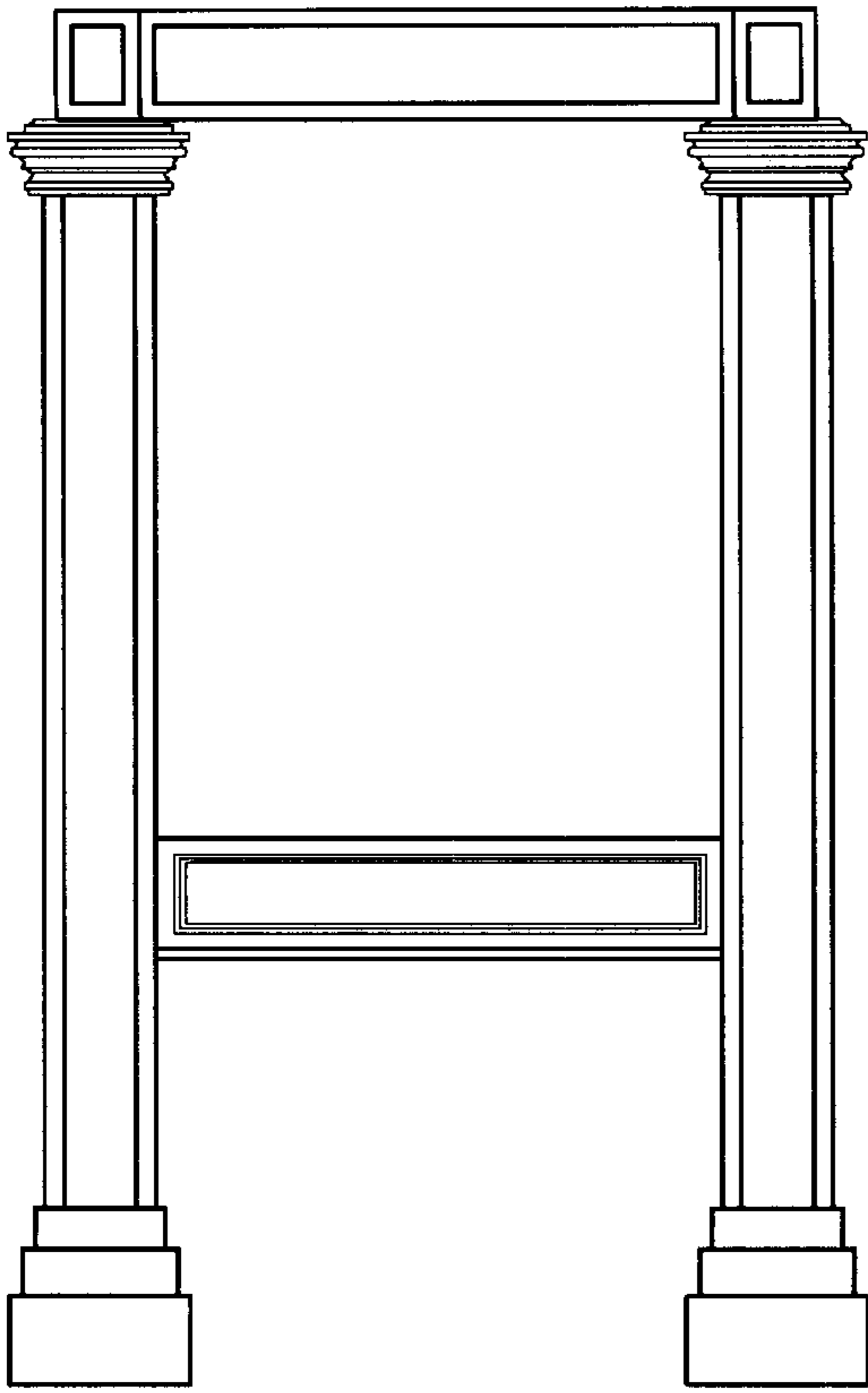

FIG. 4

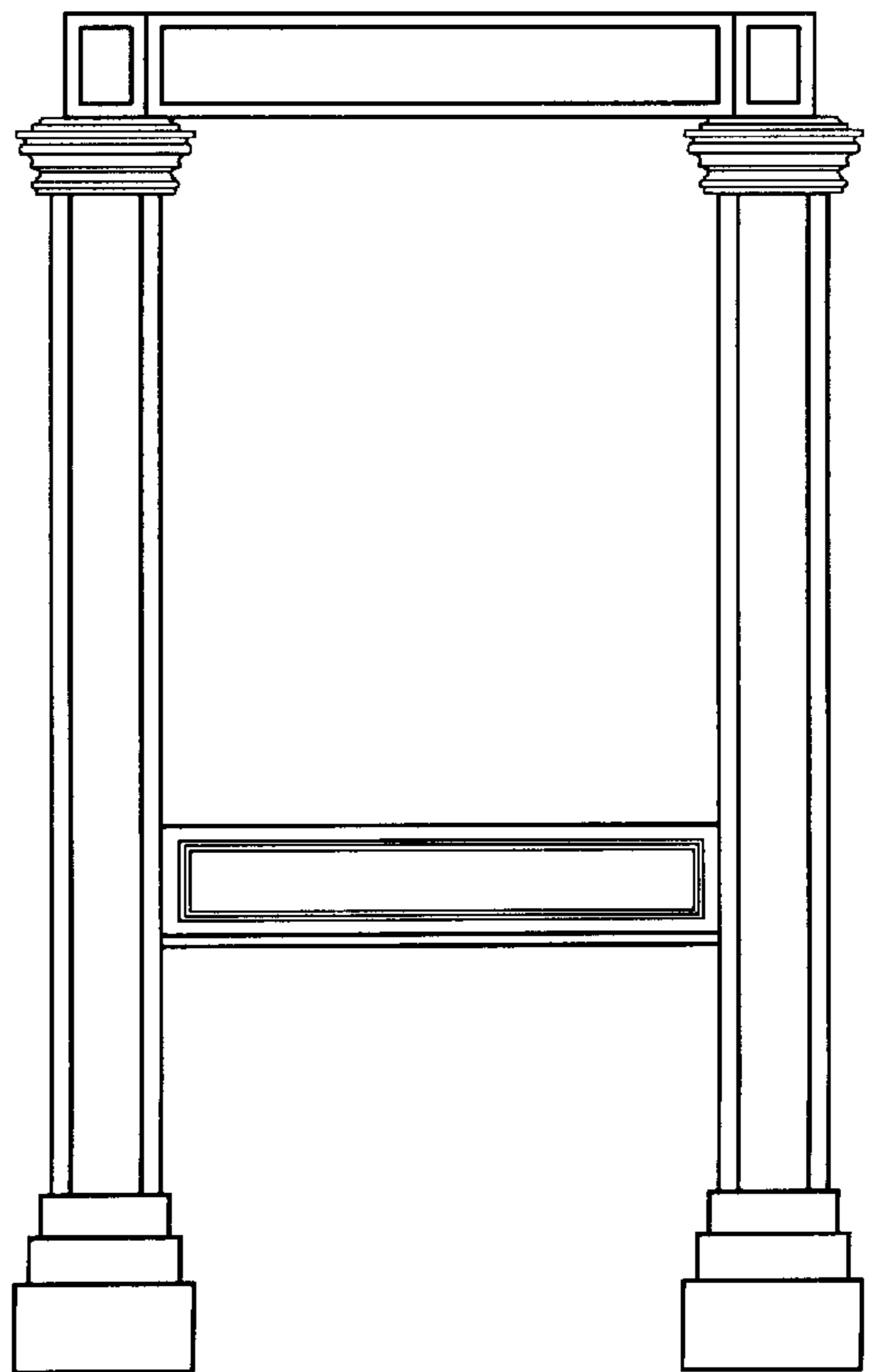

FIG. 5

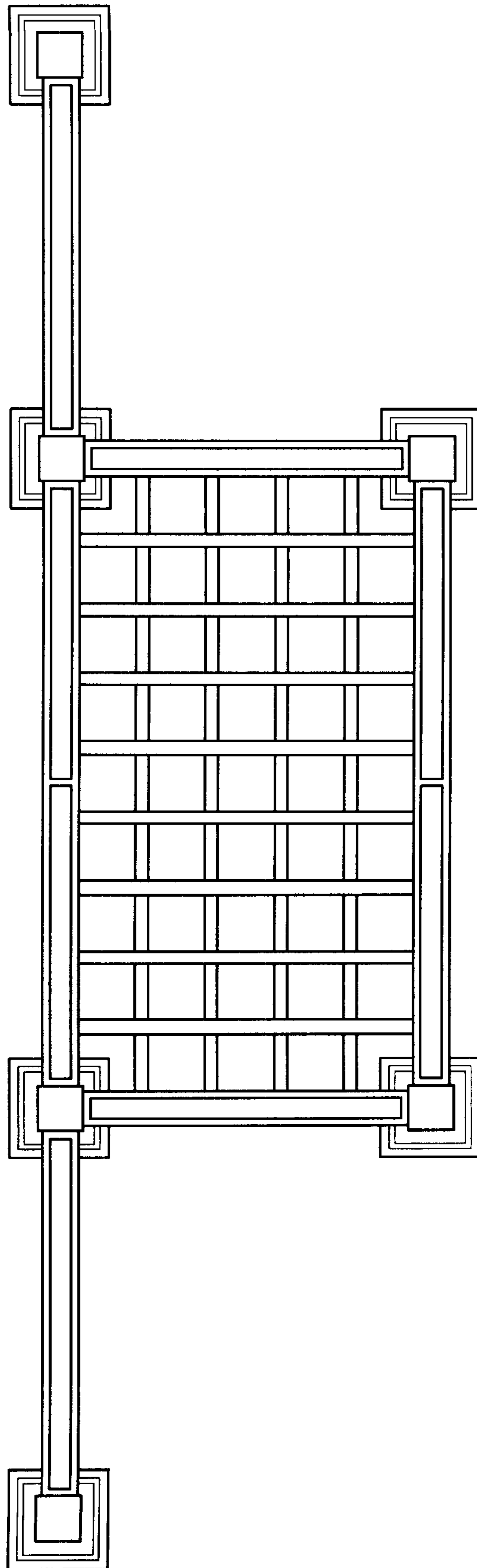

FIG. 6