



US00D467347S

(12) **United States Design Patent**
Yang

(10) **Patent No.:** **US D467,347 S**

(45) **Date of Patent:** **** Dec. 17, 2002**

(54) **ULTRASONIC MASSAGER**

5,925,002 A * 7/1999 Wollman 601/70

(75) Inventor: **Seong-Seok Yang**, Seongnam (KR)

* cited by examiner

(73) Assignee: **Coretech Co., Ltd.** (KR)

Primary Examiner—Stella Reid

(**) Term: **14 Years**

(74) *Attorney, Agent, or Firm*—Greensfelder, Hemker & Gale, P.C.

(21) Appl. No.: **29/157,891**

(57) **CLAIM**

(22) Filed: **Mar. 27, 2002**

The ornamental design for an ultrasonic massager, as shown and described.

(30) **Foreign Application Priority Data**

DESCRIPTION

Sep. 28, 2001 (KR) 01-27503

FIG. 1 is a front elevational view of the design for an ultrasonic massager;

(51) **LOC (7) Cl.** **24-04**

FIG. 2 is a rear elevational view of the design of FIG. 1;

(52) **U.S. Cl.** **D24/215**

FIG. 3 is a top plan view of the design of FIG. 1;

(58) **Field of Search** D24/200, 211,
D24/214, 215; 604/18, 46, 72, 78, 80, 84,
87, 93, 101, 134, 135

FIG. 4 is a bottom plan view of the design of FIG. 1;

FIG. 5 is a left side elevational view of the design of FIG. 1;

(56) **References Cited**

FIG. 6 is a right side elevational view of the design of FIG. 1; and,

U.S. PATENT DOCUMENTS

FIG. 7 is a top, front, left side perspective view of the design of FIG. 1.

- 4,846,158 A * 7/1989 Teranishi 601/72
- D331,467 S * 12/1992 Wollman D24/214
- D383,849 S * 9/1997 Wollman D24/215
- D388,175 S * 12/1997 Lie D24/215

The surface(s) or portion(s) of the article not shown in the drawing or described in the specification form(s) no part of the claimed design.

1 Claim, 6 Drawing Sheets

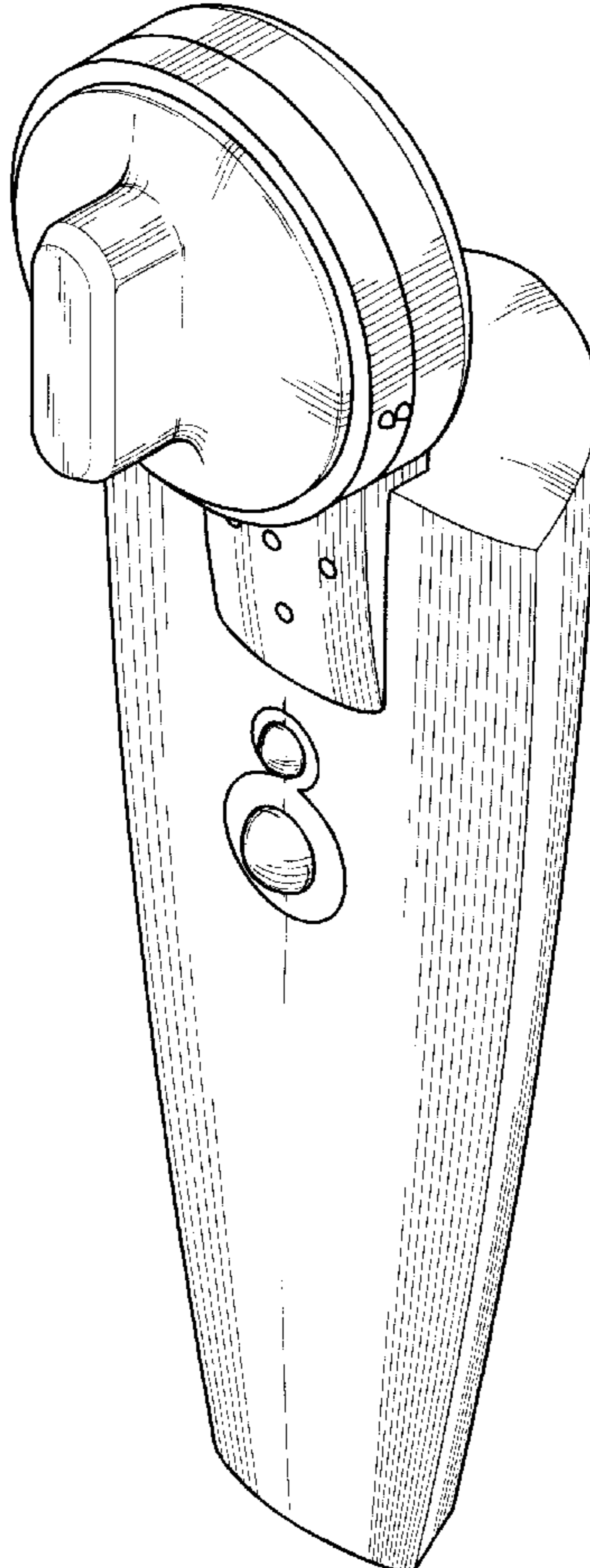

Fig. 1

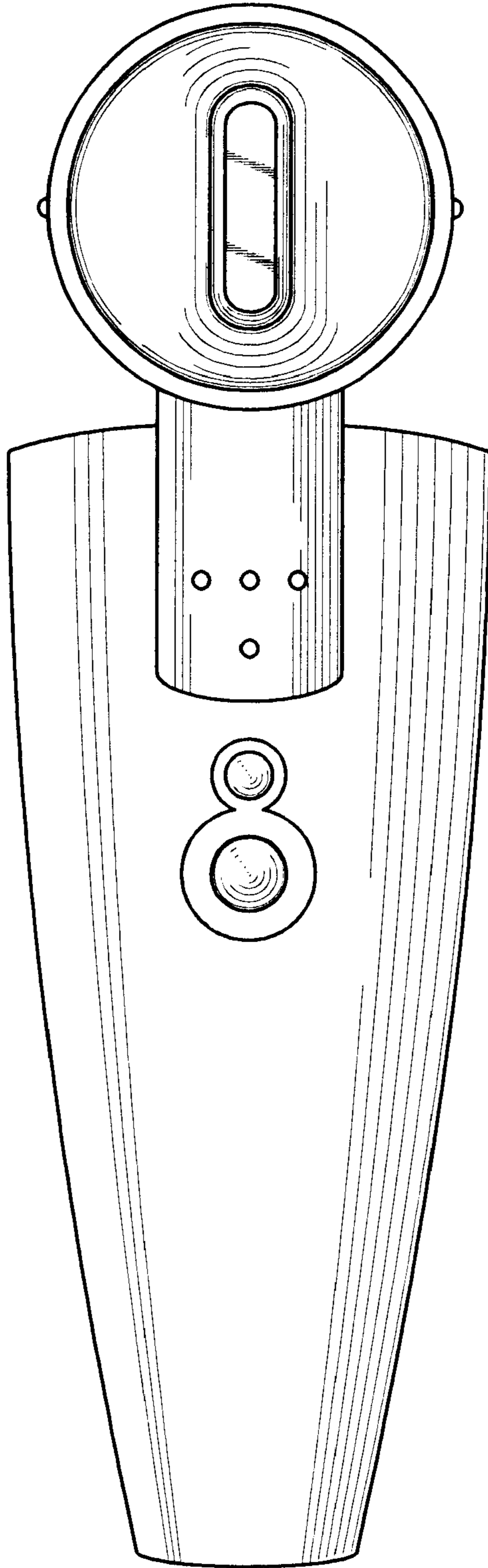

Fig. 2

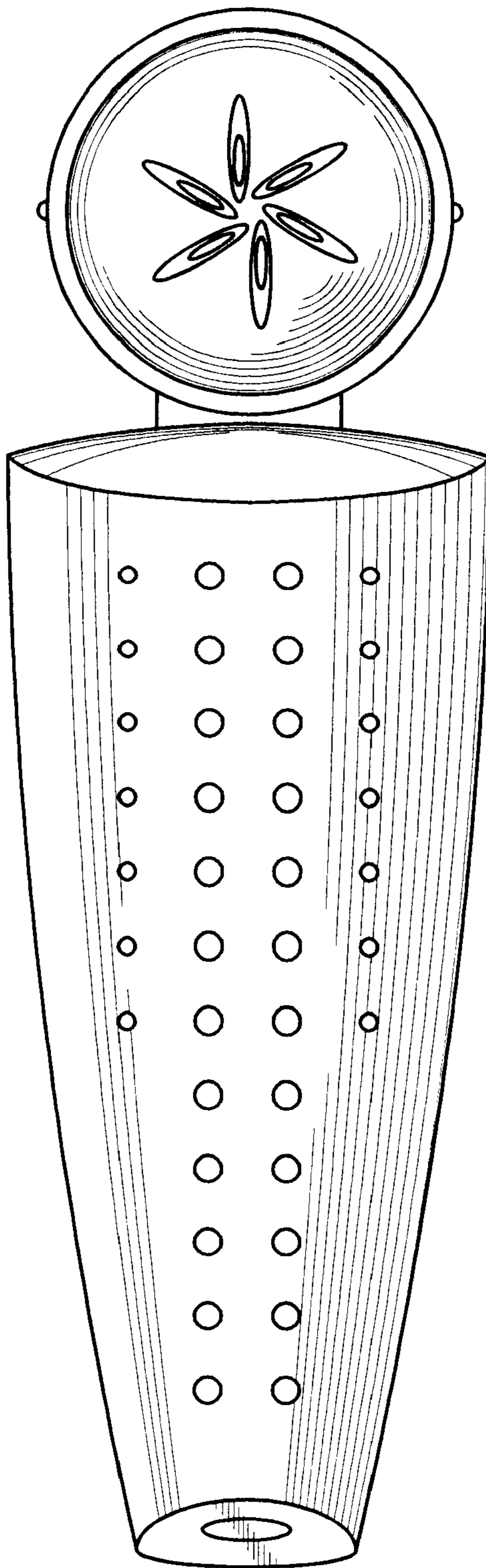

Fig. 3

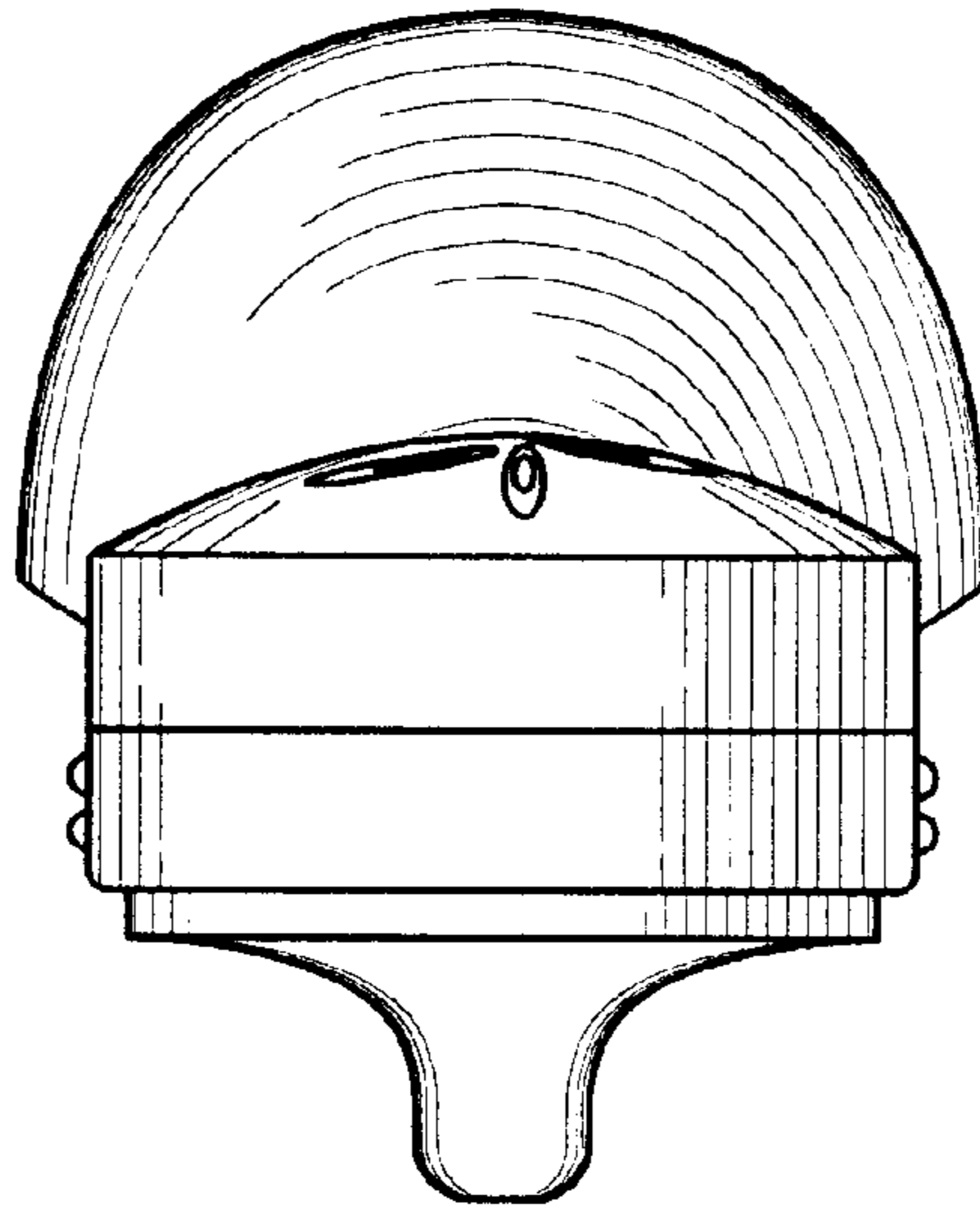

Fig. 4

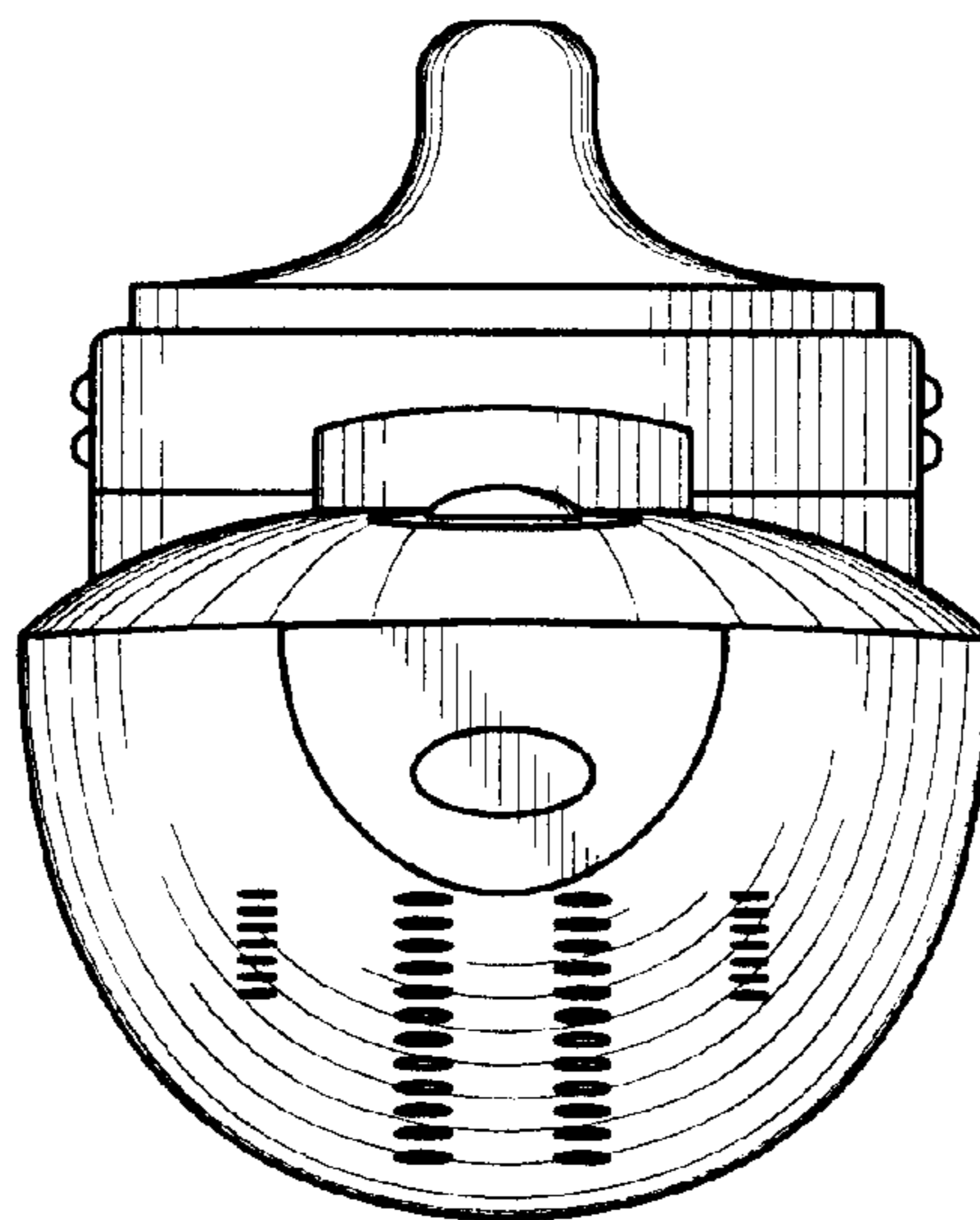

Fig. 5

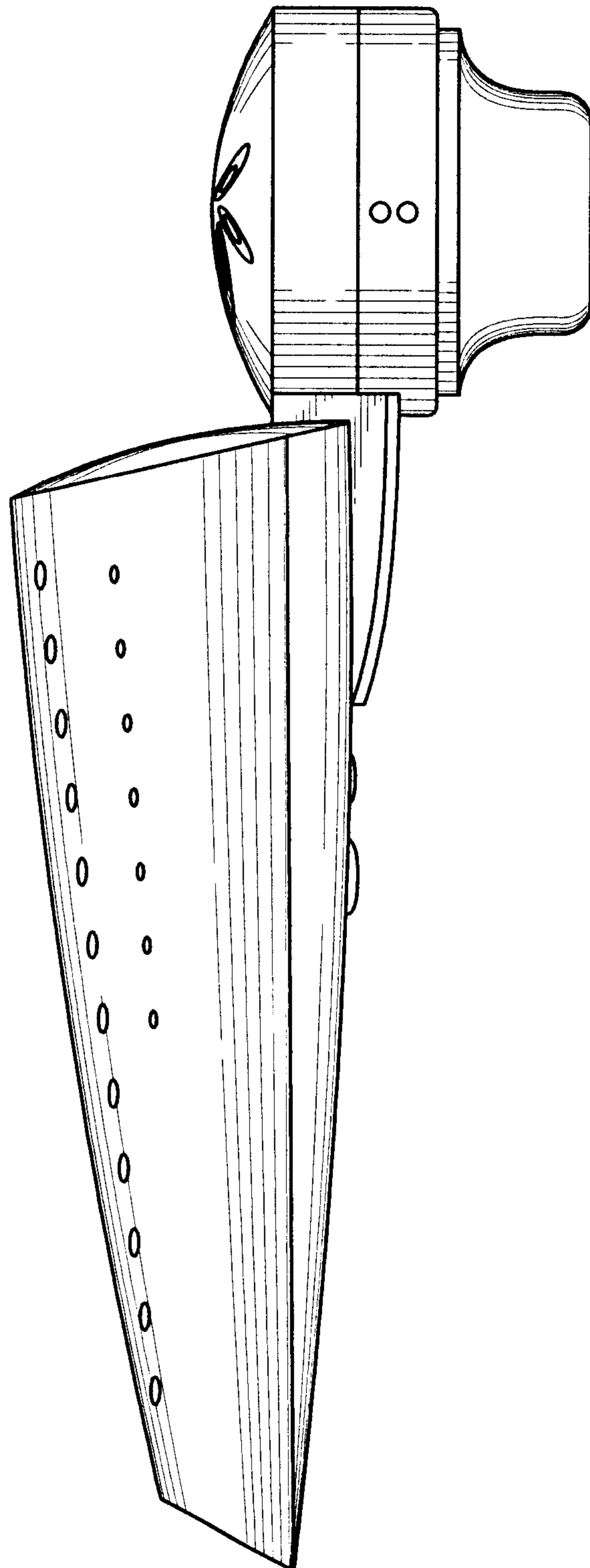

Fig. 6

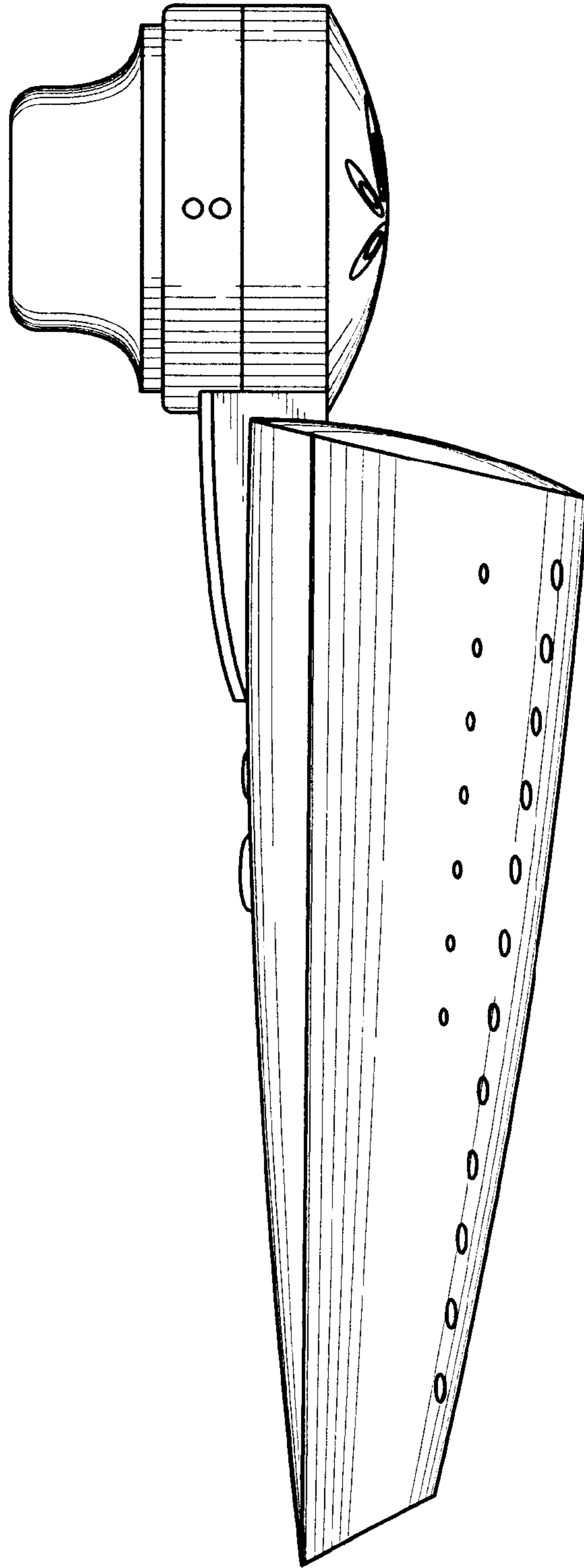

Fig. 7

