



US00D467326S

(12) **United States Design Patent**  
**Shapiro**

(10) **Patent No.:** **US D467,326 S**

(45) **Date of Patent:** **\*\* Dec. 17, 2002**

(54) **HEATER**

(75) Inventor: **Barry Shapiro**, Doylestown, PA (US)

(73) Assignee: **Lasko Holdings, Inc.**, West Chester, PA (US)

(\*\*) Term: **14 Years**

(21) Appl. No.: **29/154,278**

(22) Filed: **Jan. 23, 2002**

(51) **LOC (7) Cl.** ..... **23-03**

(52) **U.S. Cl.** ..... **D23/336**

(58) **Field of Search** ..... D23/314, 328,  
D23/332, 335-341, 378; 126/90 A, 92 A,  
92 B, 92 AC; 312/236; 392/365-9, 373-6,  
352, 434

(56) **References Cited**

**U.S. PATENT DOCUMENTS**

D147,417 S \* 9/1947 Palma, Jr. .... D23/336  
D150,360 S \* 7/1948 Hutcheson ..... D23/336

D326,318 S \* 5/1992 Coup et al. .... D23/335  
D353,660 S \* 12/1994 Cuning ..... D23/328  
D384,733 S \* 10/1997 Jane et al. .... D23/328  
D384,734 S \* 10/1997 Ellwood ..... D23/335

\* cited by examiner

*Primary Examiner*—B. J. Bullock

(74) *Attorney, Agent, or Firm*—Zachary T. Wobensmith, III

(57) **CLAIM**

The ornamental design for a heater, as shown and described.

**DESCRIPTION**

FIG. 1 is a perspective view of the heater, showing my design;  
FIG. 2 is a front view thereof;  
FIG. 3 is a rear view thereof;  
FIG. 4 is a right side elevational view thereof;  
FIG. 5 is a left side elevational view thereof;  
FIG. 6 is a top plan view thereof; and,  
FIG. 7 is a bottom plan view thereof.  
FIGS. 4-7 are shown on an enlarged scale.

**1 Claim, 7 Drawing Sheets**

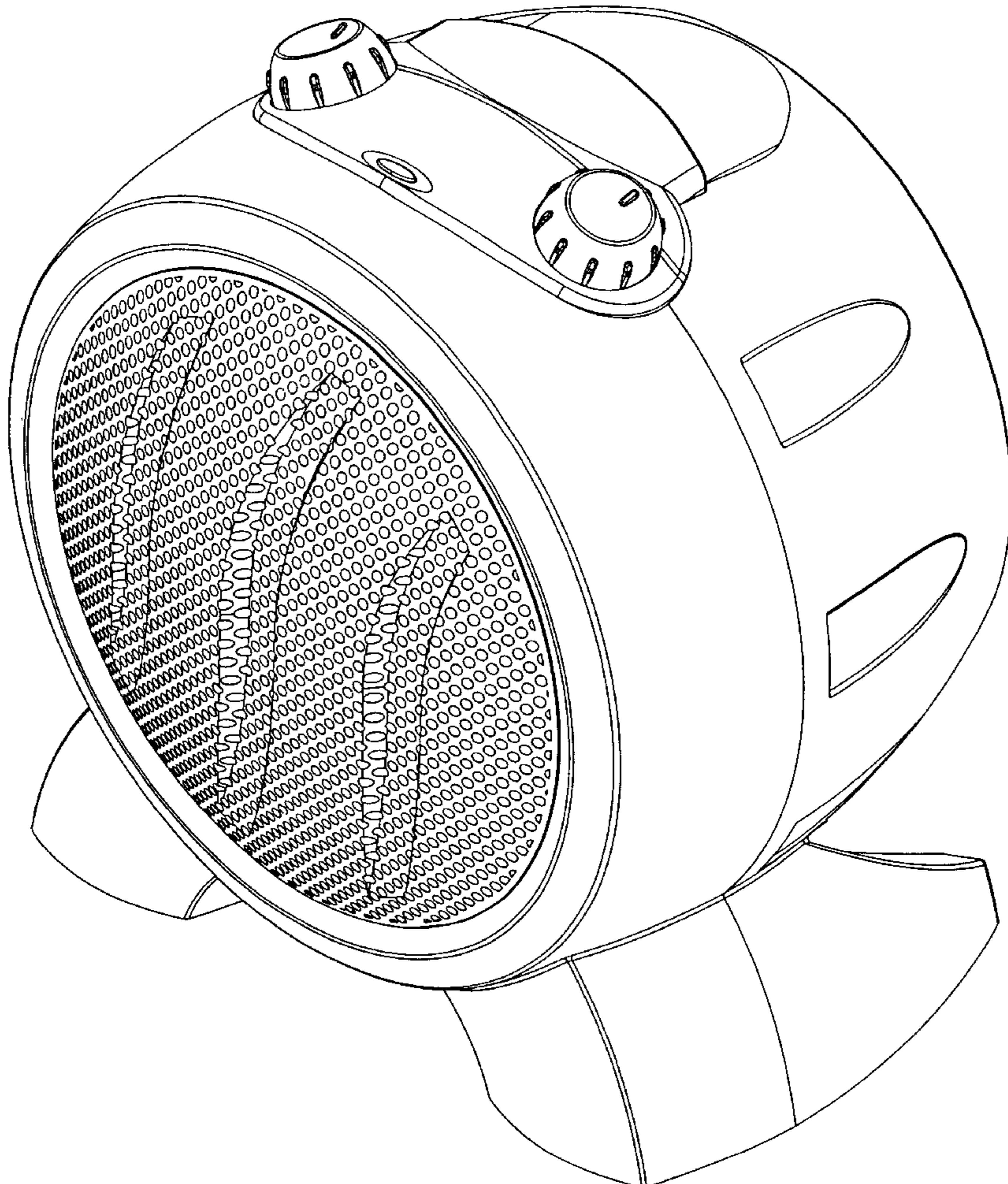

Fig. 1

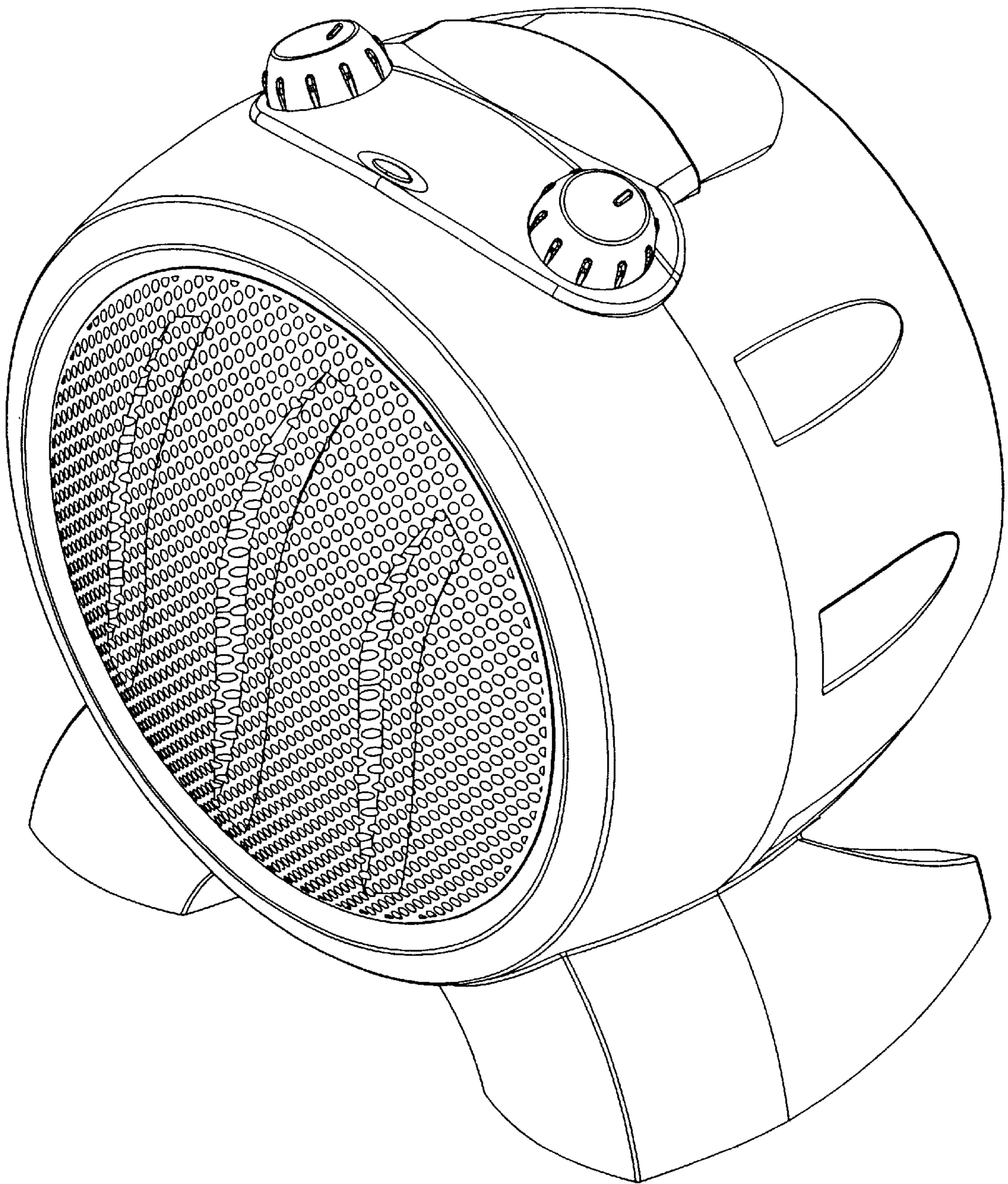
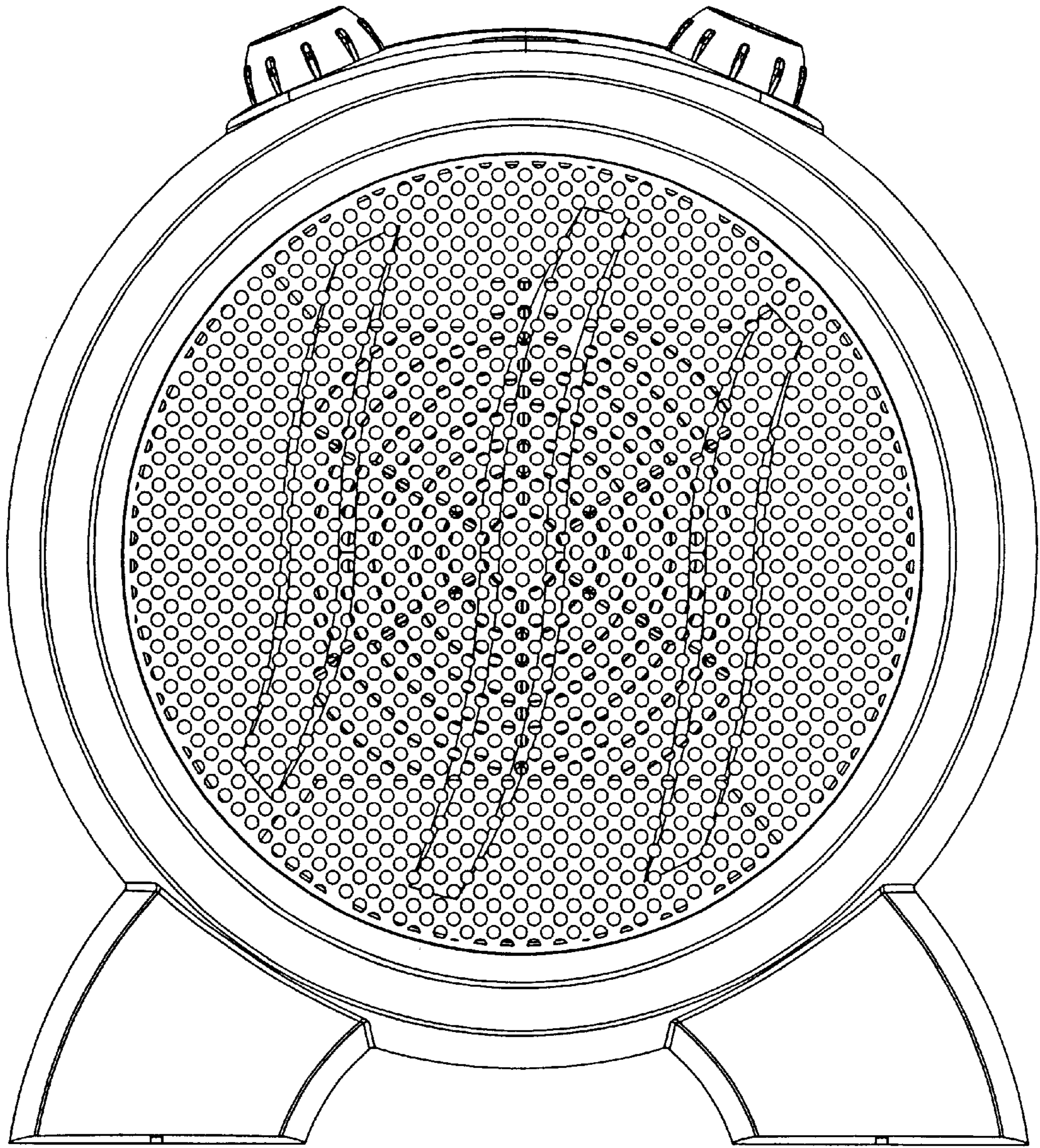
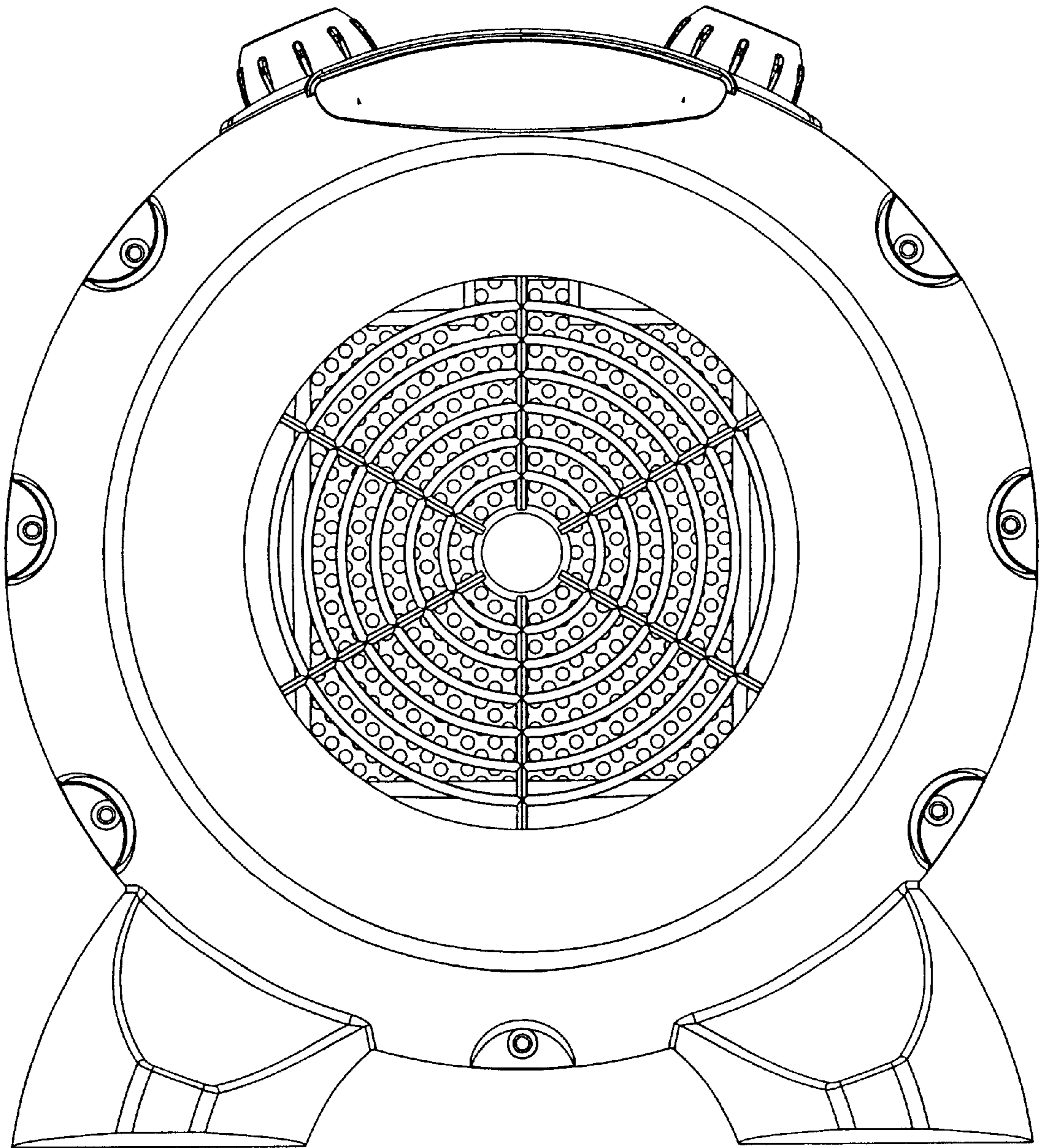

Fig. 2



*Fig. 3*



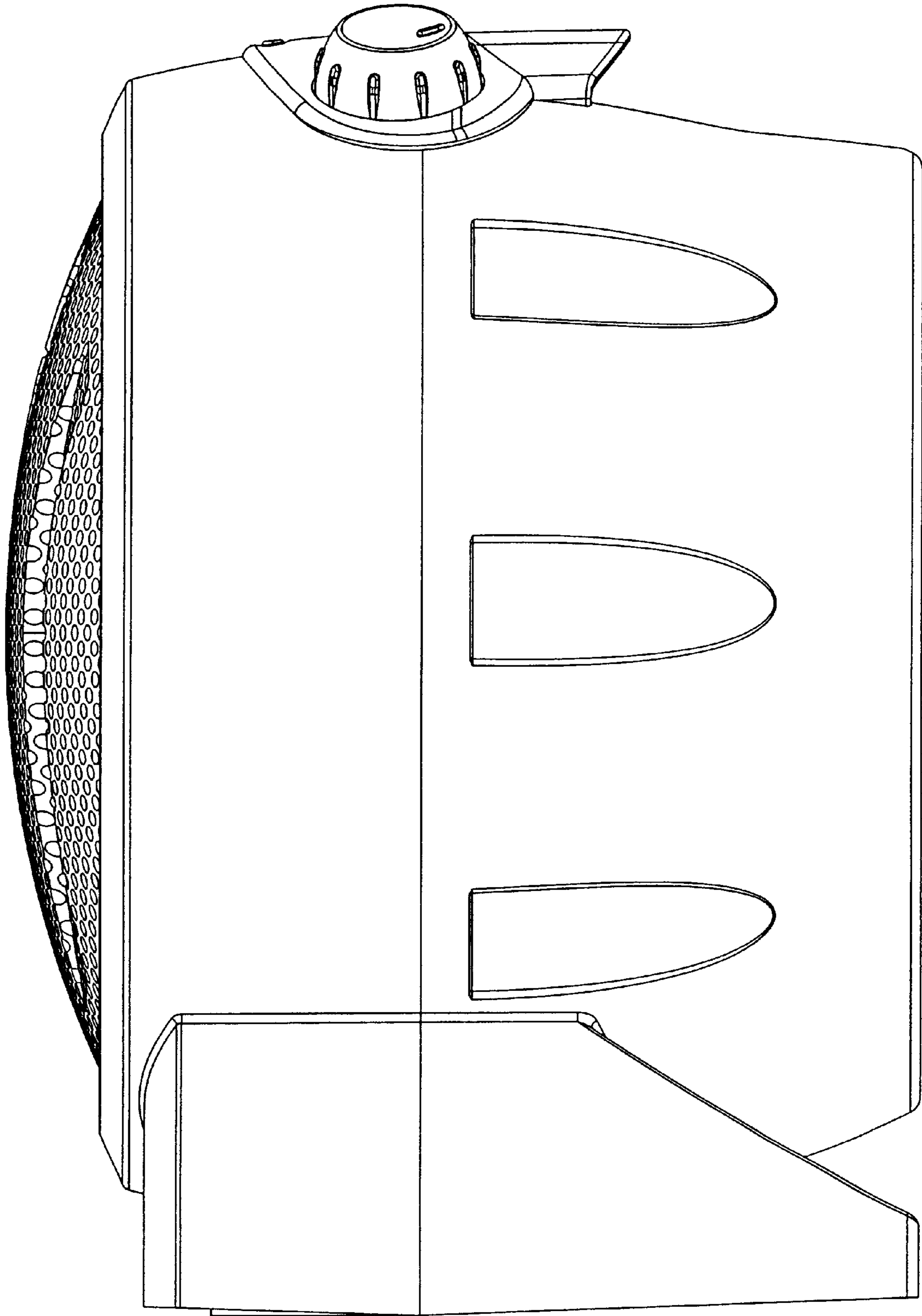

Fig. 4

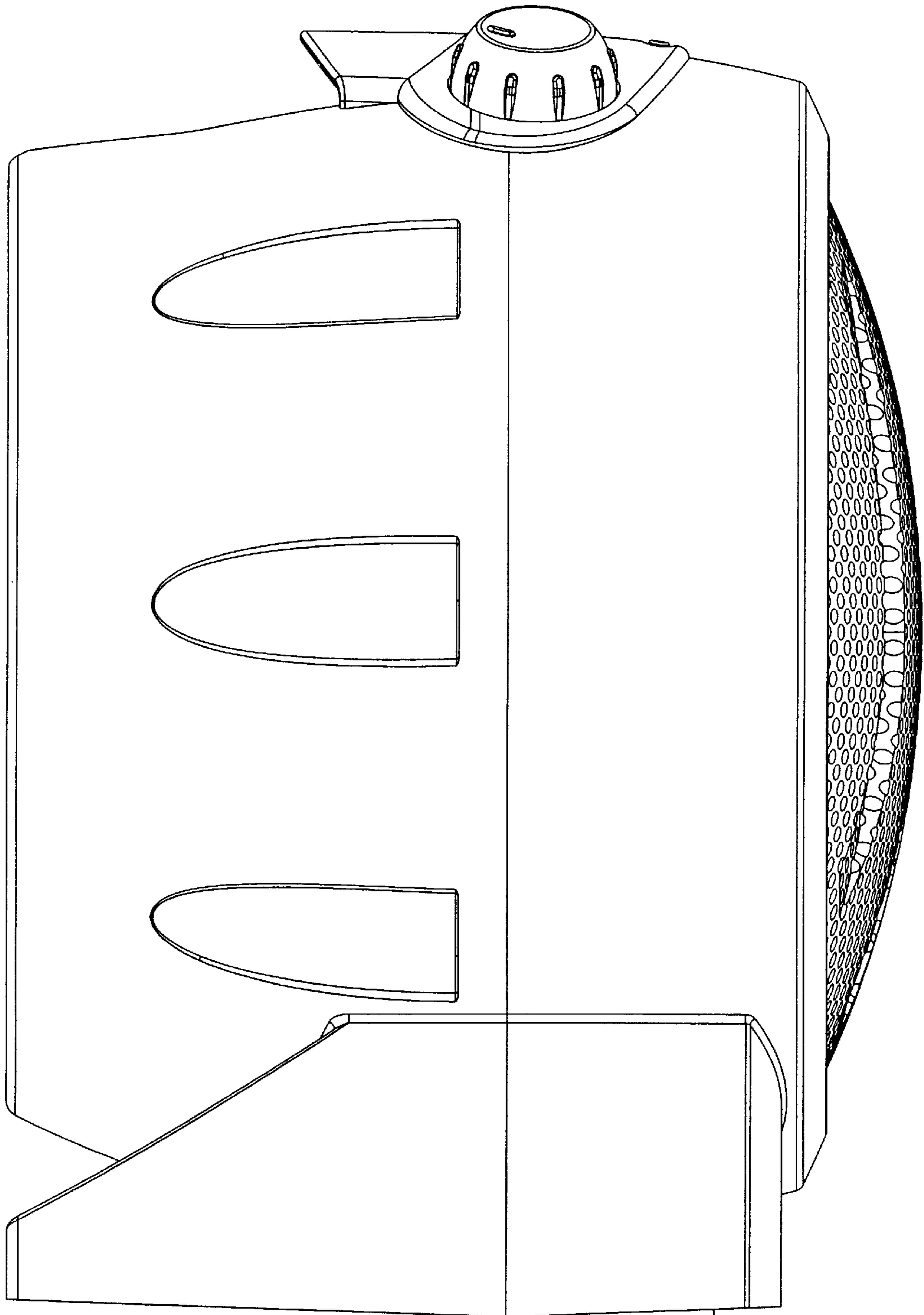

Fig. 5

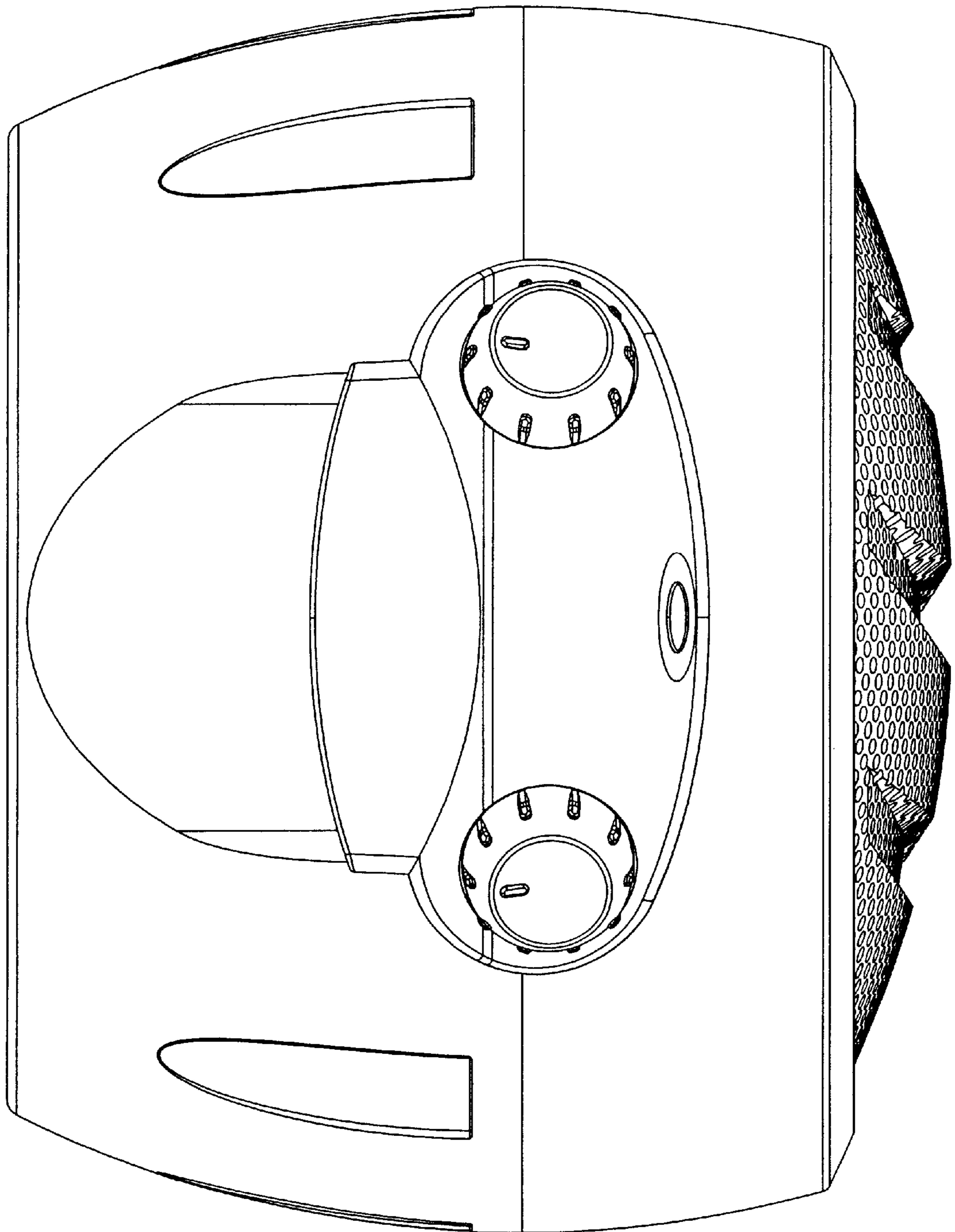

Fig. 6

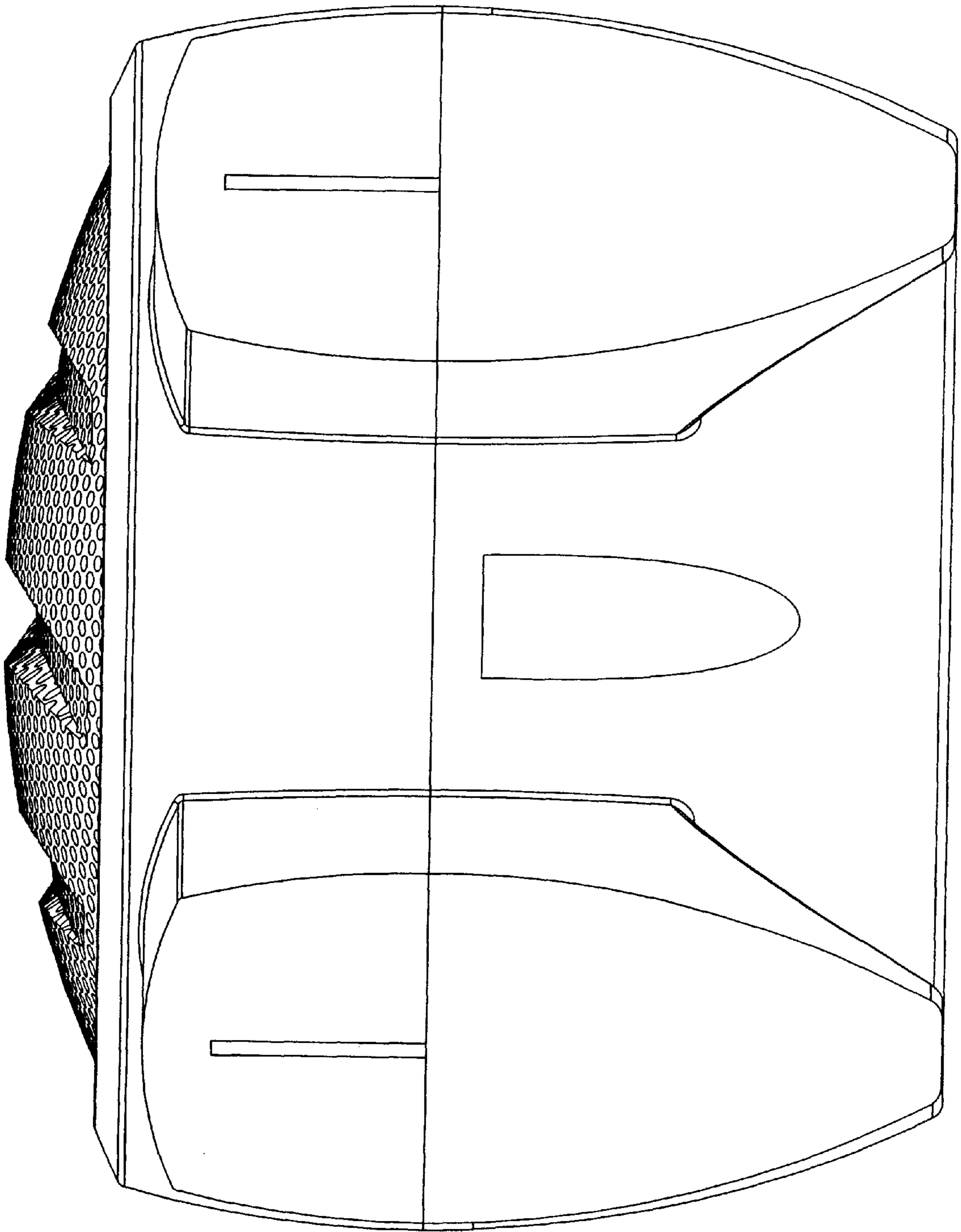

Fig. 7