

US00D467300S

(12) **United States Design Patent**
Singtoroj

(10) **Patent No.:** **US D467,300 S**

(45) **Date of Patent:** **** Dec. 17, 2002**

(54) **SHOWER HEAD AND ARM**

(75) Inventor: **Yos Singtoroj**, Anaheim, CA (US)

(73) Assignee: **Emhart LLC**, Newark, DE (US)

(**) Term: **14 Years**

(21) Appl. No.: **29/152,107**

(22) Filed: **Dec. 13, 2001**

(51) **LOC (7) Cl.** **23-01**

(52) **U.S. Cl.** **D23/213; D23/229**

(58) **Field of Search** **D23/213, 223,**
D23/229, 230, 228; 239/587.1, 587.2, 587.3,
548; 4/615

D215,092 S 9/1969 Vicknair et al.
D260,809 S * 9/1981 Fleischmann D23/229
D309,496 S * 7/1990 Ramsey et al. D23/230
D385,335 S 10/1997 Caroen et al.
D386,247 S 11/1997 Garwood
D443,021 S 5/2001 Maddox et al.
6,276,004 B1 * 8/2001 Bertrand et al. 4/615

* cited by examiner

Primary Examiner—Robin V. Taylor

(74) *Attorney, Agent, or Firm*—Richard J. Veltman; John D. Del Ponti

(57) **CLAIM**

The ornamental design for a shower head and arm, as shown and described.

DESCRIPTION

FIG. 1 is a perspective view of the new design for a shower head and arm;
FIG. 2 is a right elevational view of the new design for a shower head and arm, the left elevational view being a mirror image;
FIG. 3 is a top plan view of the new design for a shower head and arm;
FIG. 4 is a bottom plan view of the new design for a shower head and arm;
FIG. 5 is a front elevational view of the new design for a shower head and arm; and,
FIG. 6 is a rear elevational view of the new design for a shower head and arm.

(56) **References Cited**

U.S. PATENT DOCUMENTS

D77,442 S 1/1929 Smith
D84,900 S 8/1931 Moran
D87,920 S 10/1932 Haws
D87,961 S 10/1932 Ferguson
D94,146 S 12/1934 Isenberg
D95,258 S 4/1935 Johnson
D95,823 S 6/1935 Hathaway et al.
D98,006 S 6/1935 Landgarten
D101,440 S * 10/1936 Dreyfuss D23/230
D113,042 S 11/1939 Landgarten
D143,737 S 2/1946 Klein
D158,298 S 4/1950 Lehman
D189,411 S 12/1960 Gilmour
2,965,313 A 12/1960 Jay
D206,515 S 12/1966 Isenberg

1 Claim, 6 Drawing Sheets

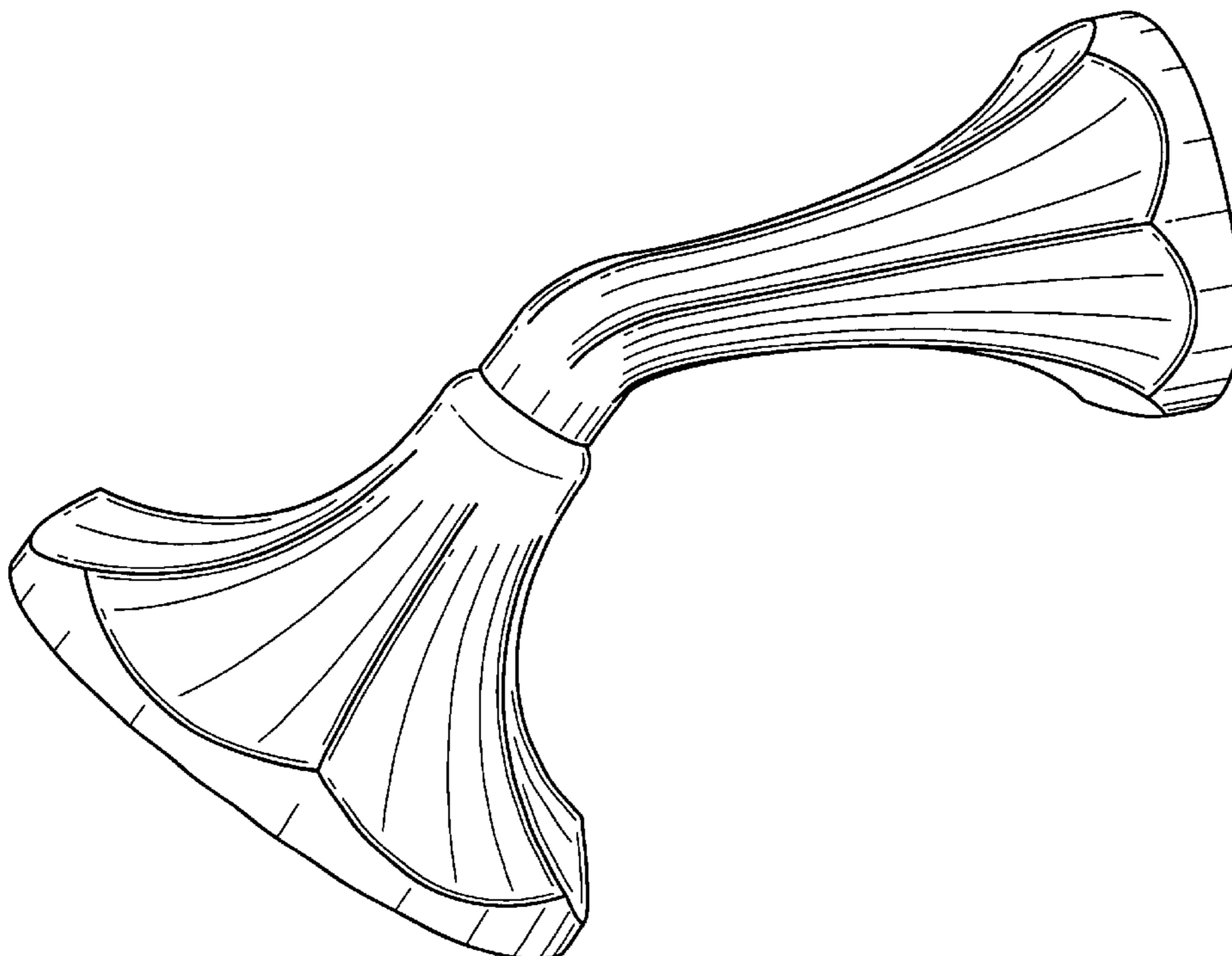

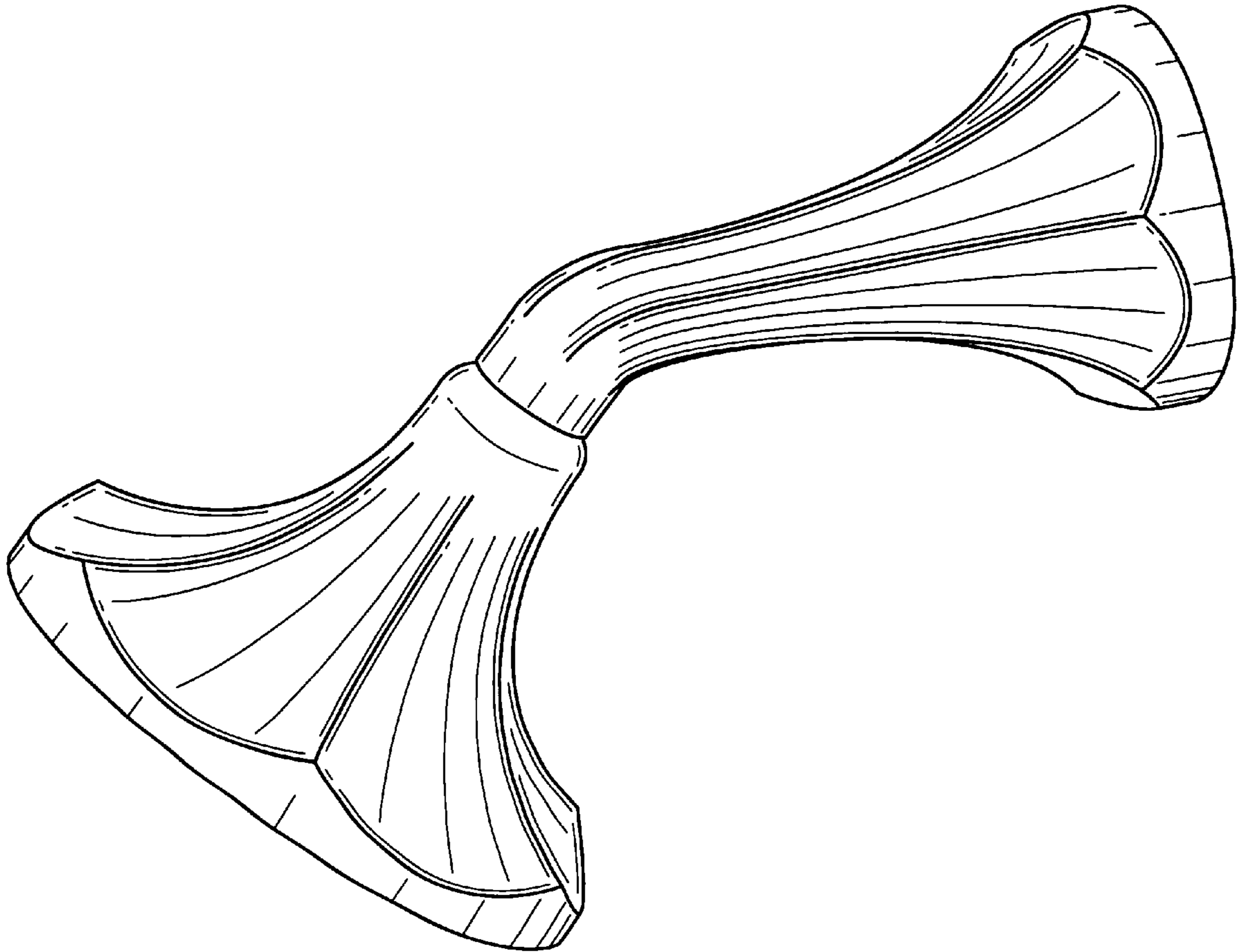

FIG. 1

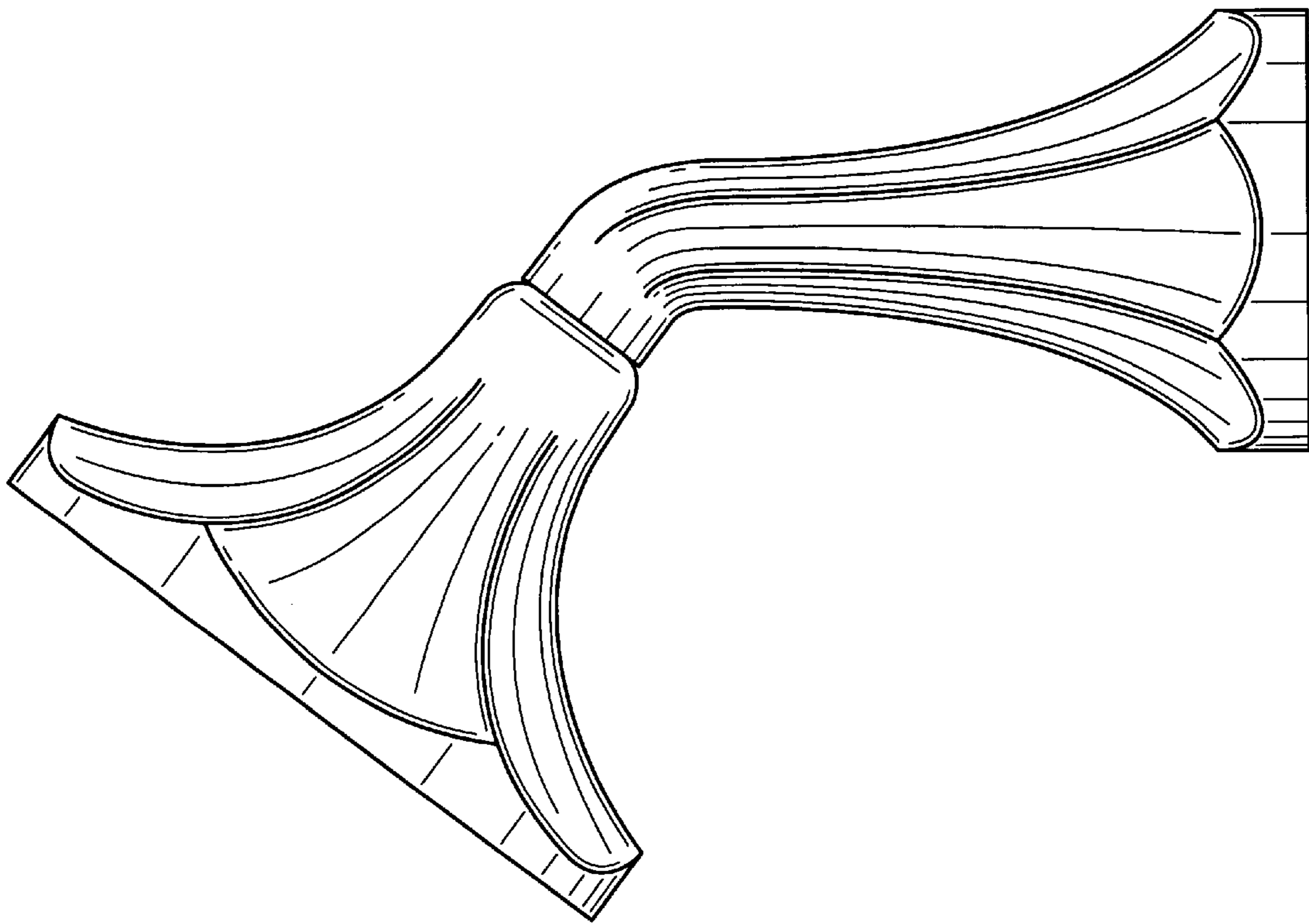

FIG. 2

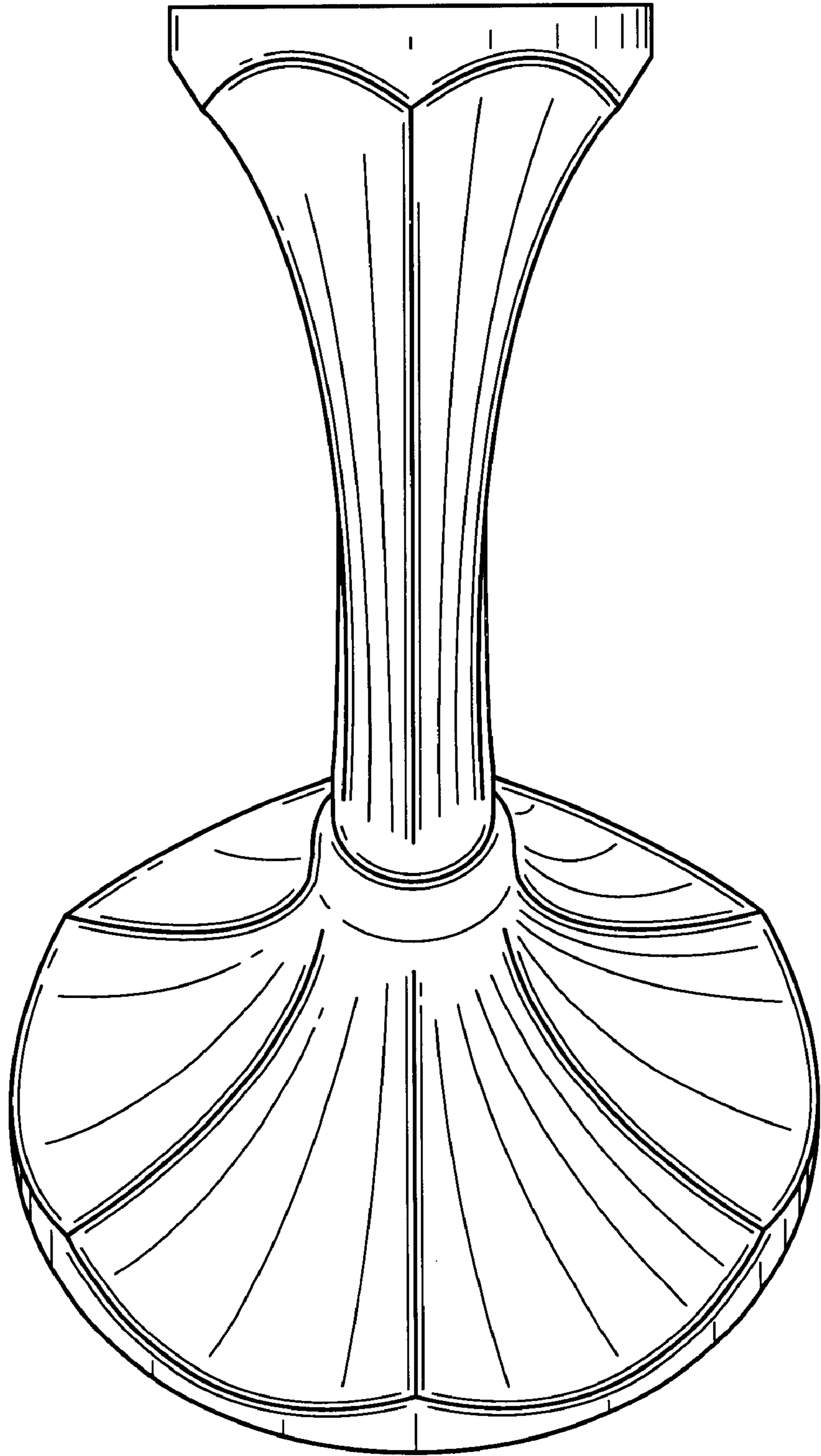

FIG. 3

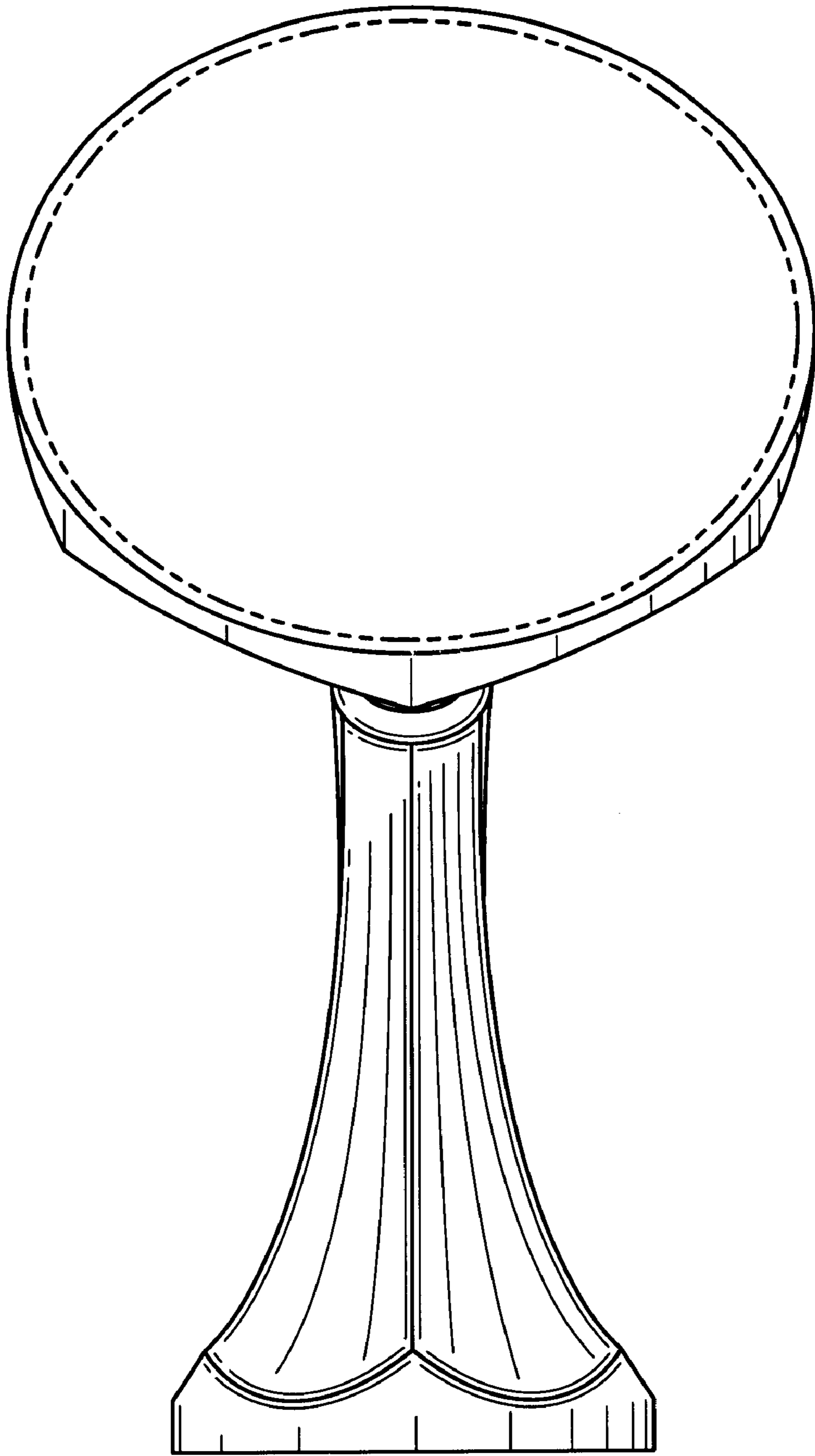

FIG. 4

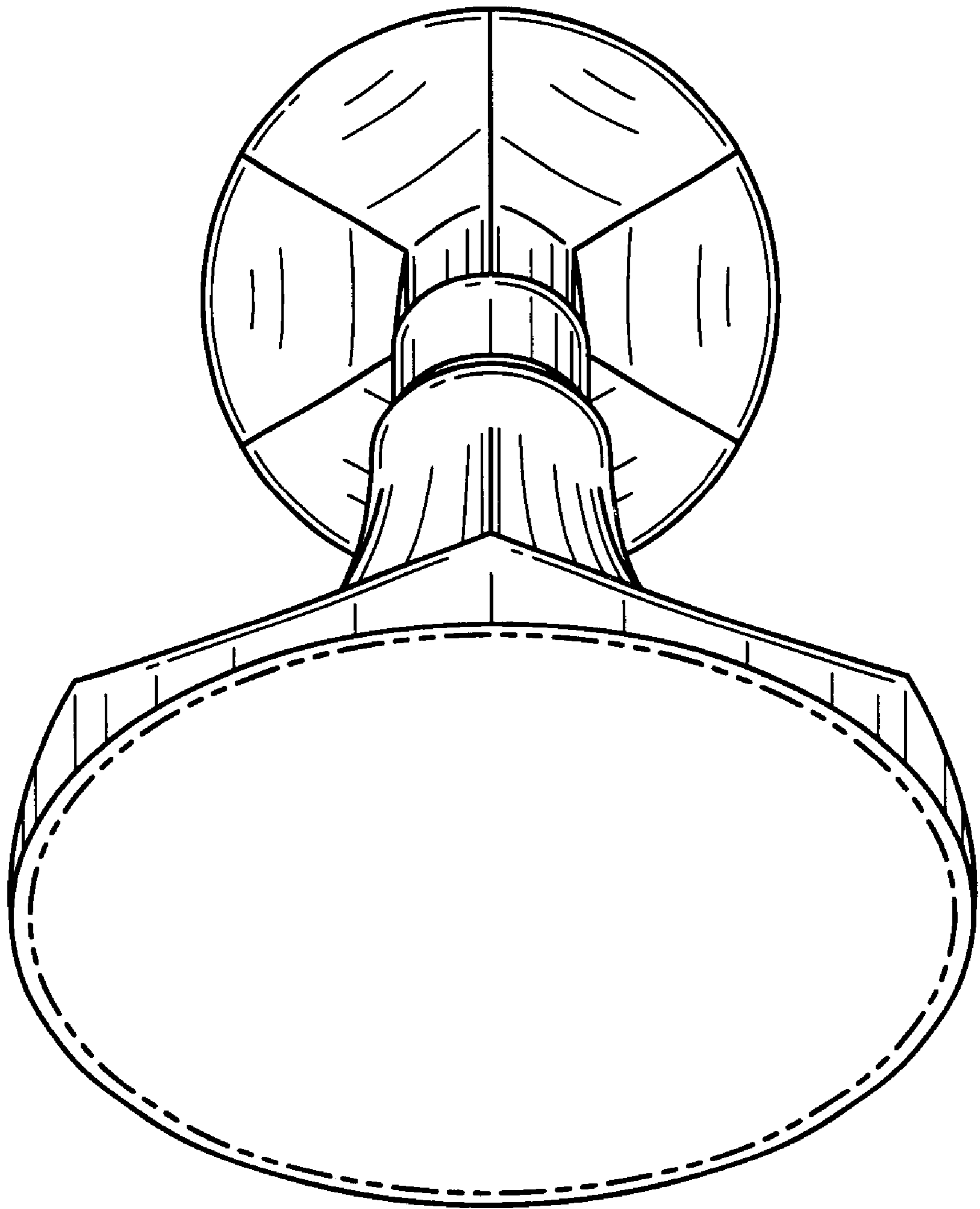

FIG. 5

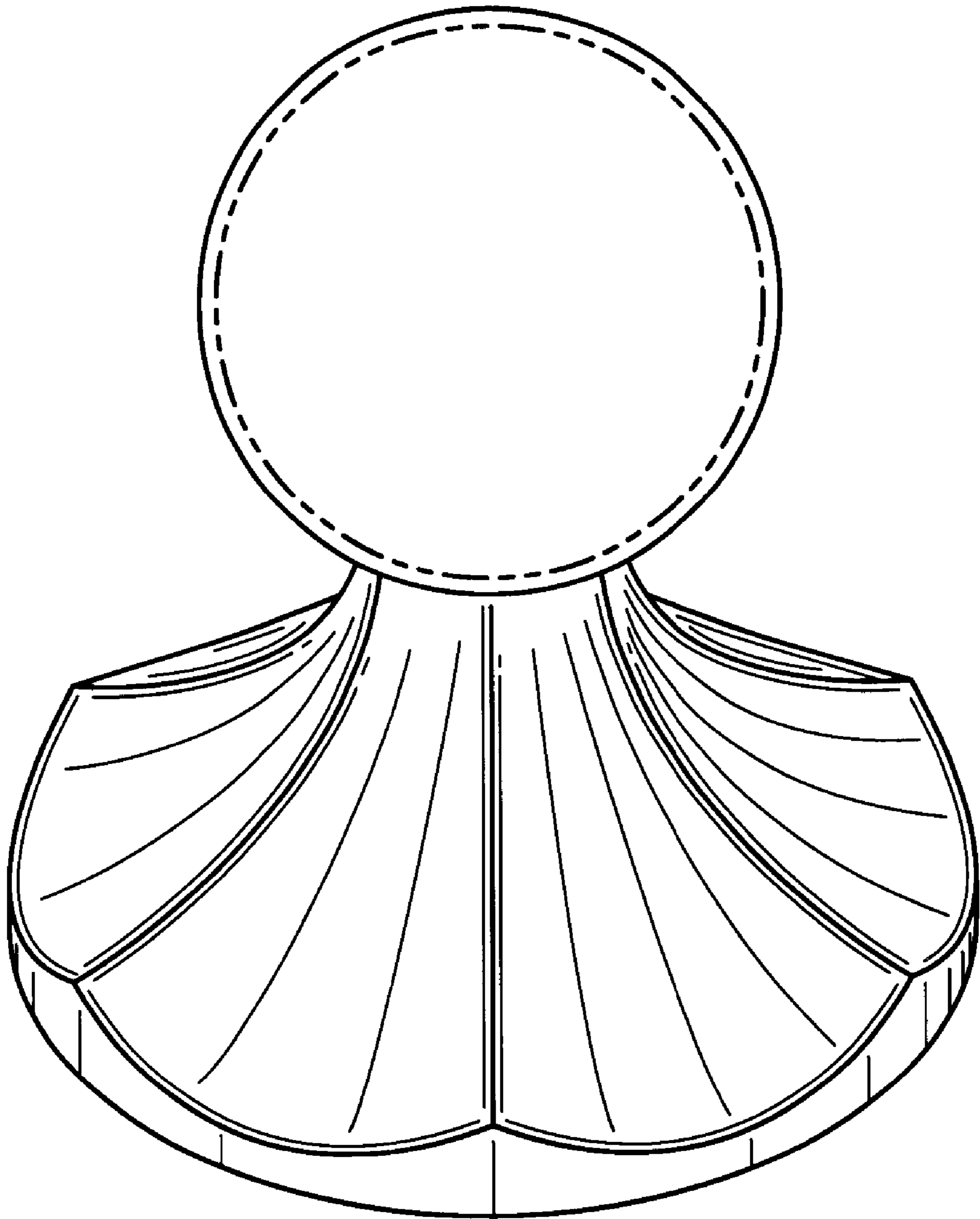

FIG. 6