



US00D467262S

(12) **United States Design Patent**
Wang

(10) **Patent No.:** **US D467,262 S**

(45) **Date of Patent:** **** Dec. 17, 2002**

(54) **COMBINATION GLASSES**

(76) **Inventor:** **Bao Lien Wang**, No. 25 Lane 150 Sec.
2 An Ho Road, Tainan (TW)

(**) **Term:** **14 Years**

(21) **Appl. No.:** **29/155,330**

(22) **Filed:** **Feb. 8, 2002**

(51) **LOC (7) Cl.** **16-06**

(52) **U.S. Cl.** **D16/326; D16/311**

(58) **Field of Search** D16/101, 300-330,
D16/332, 335, 339; D29/109, 110; 351/41,
44, 51, 52, 111, 132, 136, 156-158; 2/426,
432, 440, 446-448

(56) **References Cited**

U.S. PATENT DOCUMENTS

5,093,940	A	3/1992	Nishiyama	
D350,144	S	* 8/1994	Vasko	D16/311
5,444,876	A	8/1995	Cooper et al.	
5,682,621	A	11/1997	Park	
5,711,035	A	1/1998	Haslbeck	
D391,598	S	* 3/1998	Simioni	D16/321
5,815,235	A	9/1998	Runckel	
D404,054	S	* 1/1999	Arnette	D16/325
D408,841	S	* 4/1999	Conway	D16/326
D418,535	S	* 1/2000	Hartman	D16/326
6,074,059	A	1/2000	Glass et al.	
6,023,791	A	2/2000	Chiang	

D429,754	S	* 8/2000	Markovitz	D16/309
D431,587	S	* 10/2000	Tang	D16/326
D450,744	S	* 11/2001	Rhoades	D16/311

* cited by examiner

Primary Examiner—Raphael Barkai

(74) *Attorney, Agent, or Firm*—Charles R. Cypher; James R. Cypher

(57) **CLAIM**

The ornamental design for the combination glasses, as shown.

DESCRIPTION

FIG. 1 is a top view of the invention.
 FIG. 2 is a front view of the invention.
 FIG. 3 is a side view of the invention. The other side view is symmetrical.
 FIG. 4 is a back view of the invention.
 FIG. 5 is a bottom view of the invention.
 FIG. 6 is a taken along line 6—6 of FIG. 1.
 FIG. 7 is a top view of the invention.
 FIG. 8 is a front view of the invention.
 FIG. 9 is a side view of the invention. The other side view is symmetrical.
 FIG. 10 is a back view of the invention.
 FIG. 11 is a bottom view of the invention; and,
 FIG. 12 is a taken along line 12—12 of the FIG. 7.

1 Claim, 3 Drawing Sheets

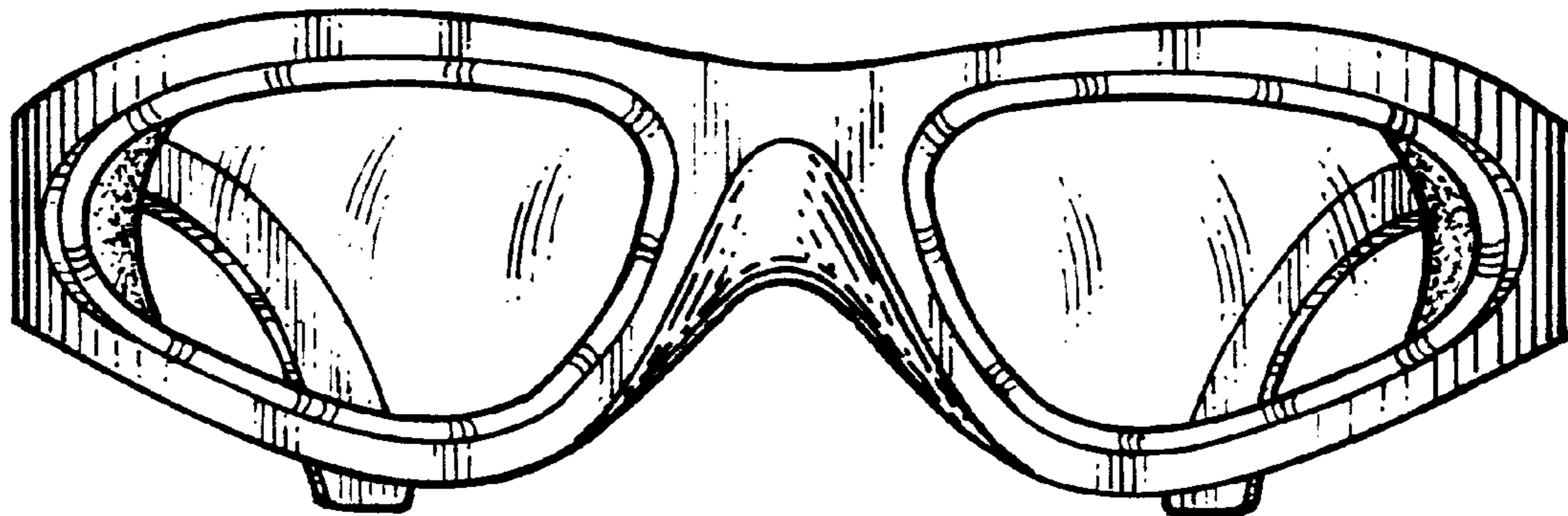

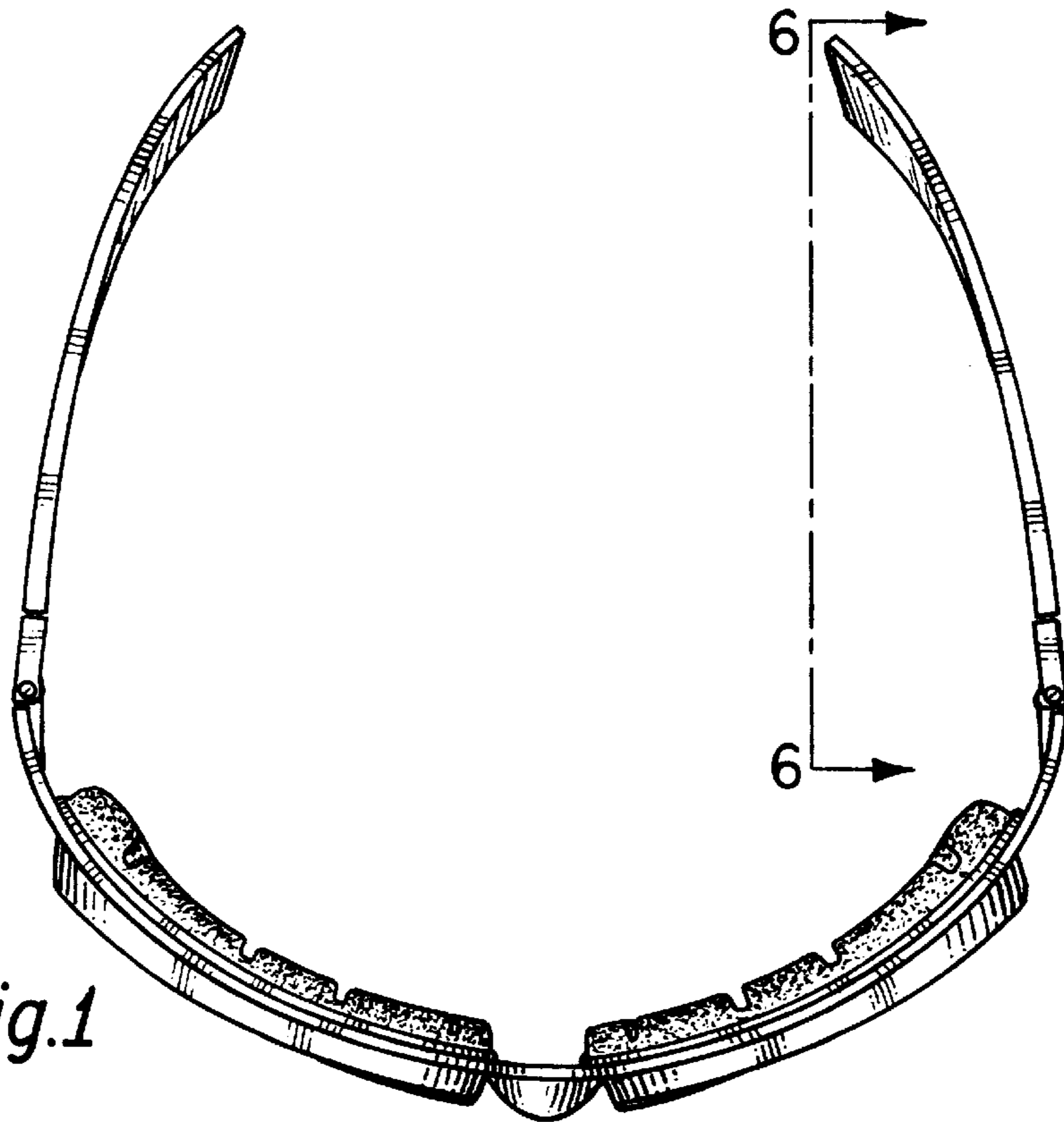

Fig.1

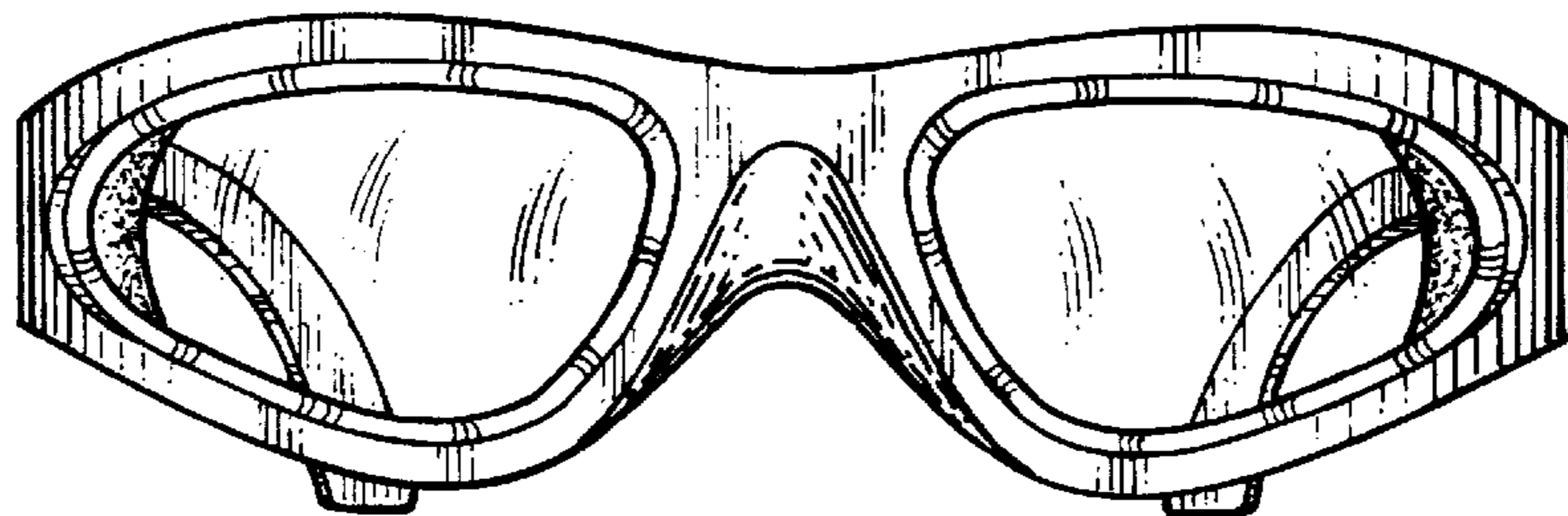

Fig.2

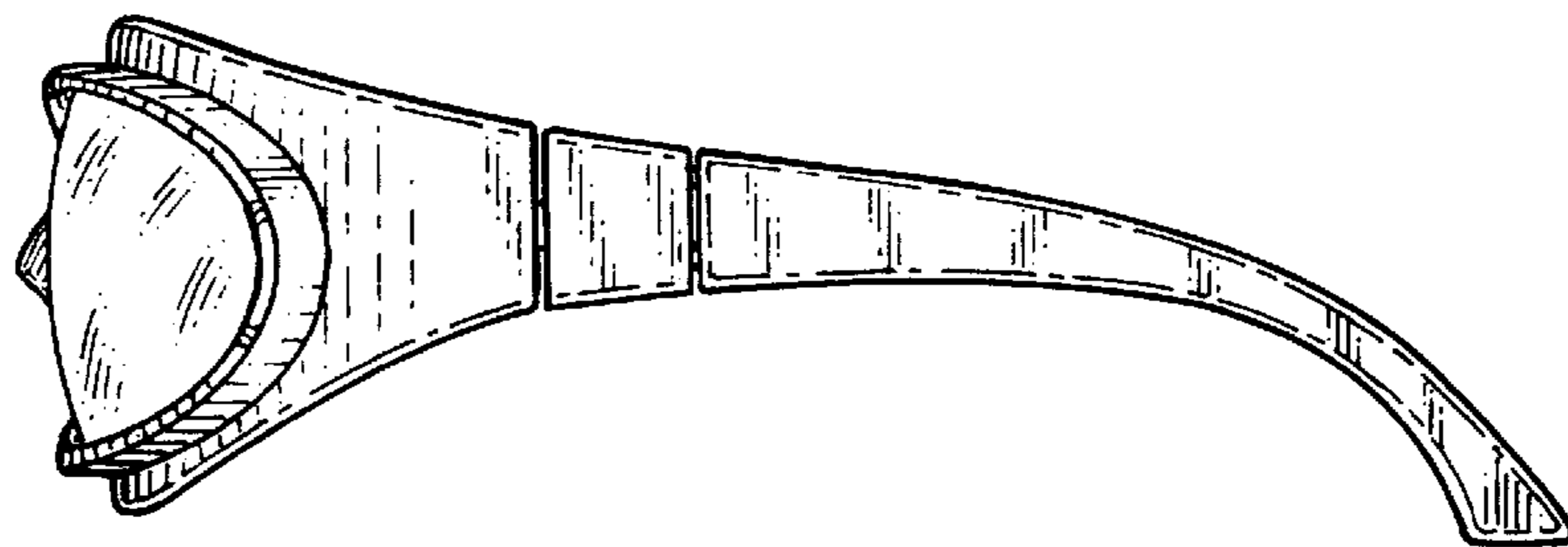

Fig.3

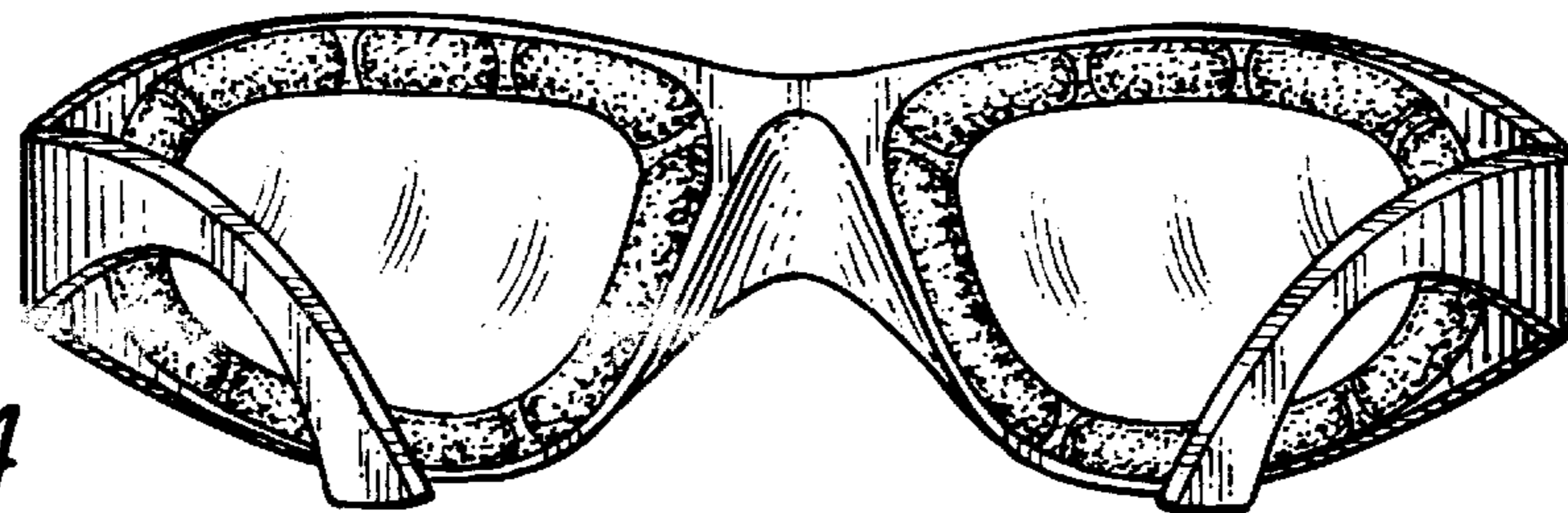

Fig.4

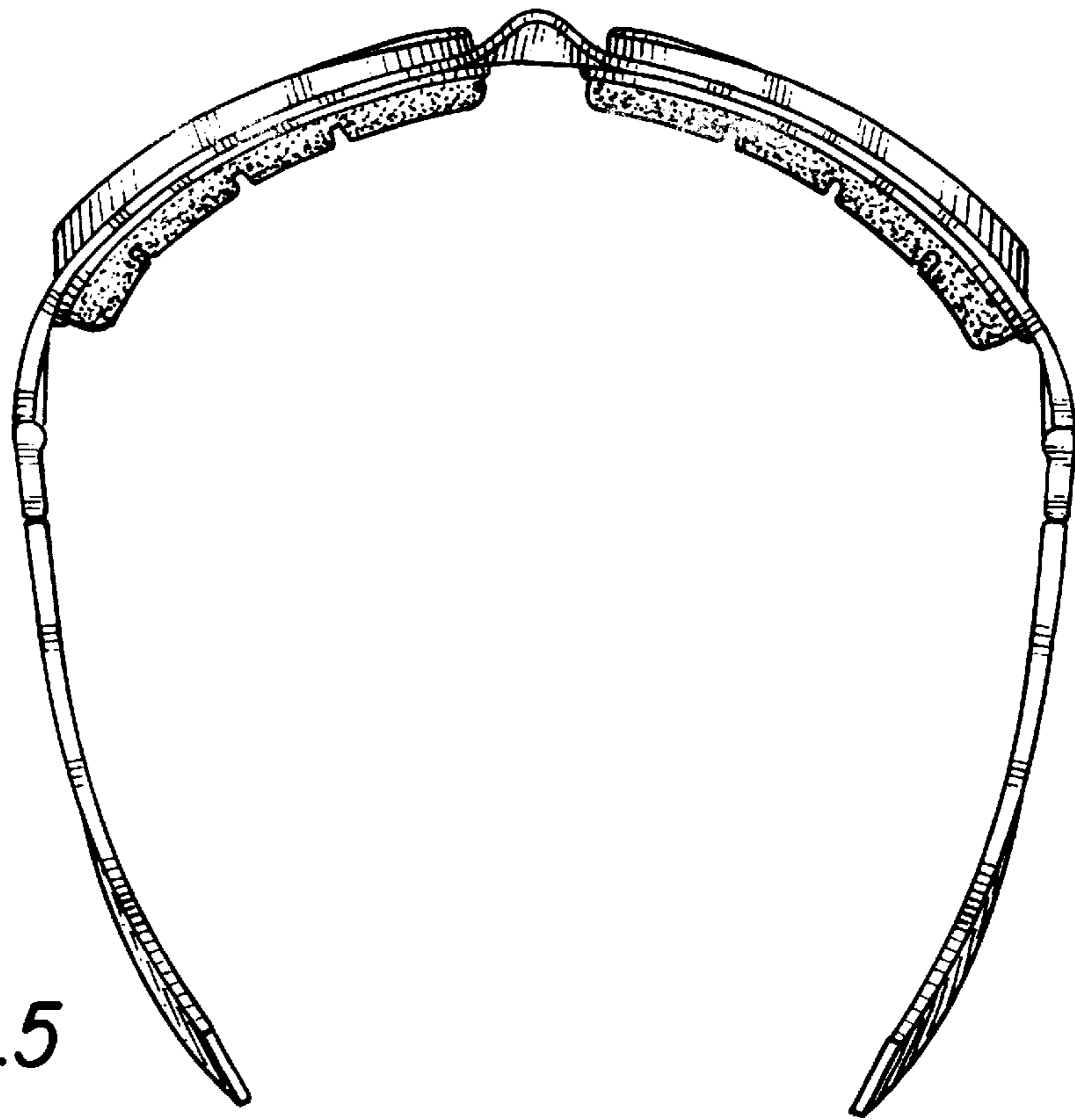

Fig. 5

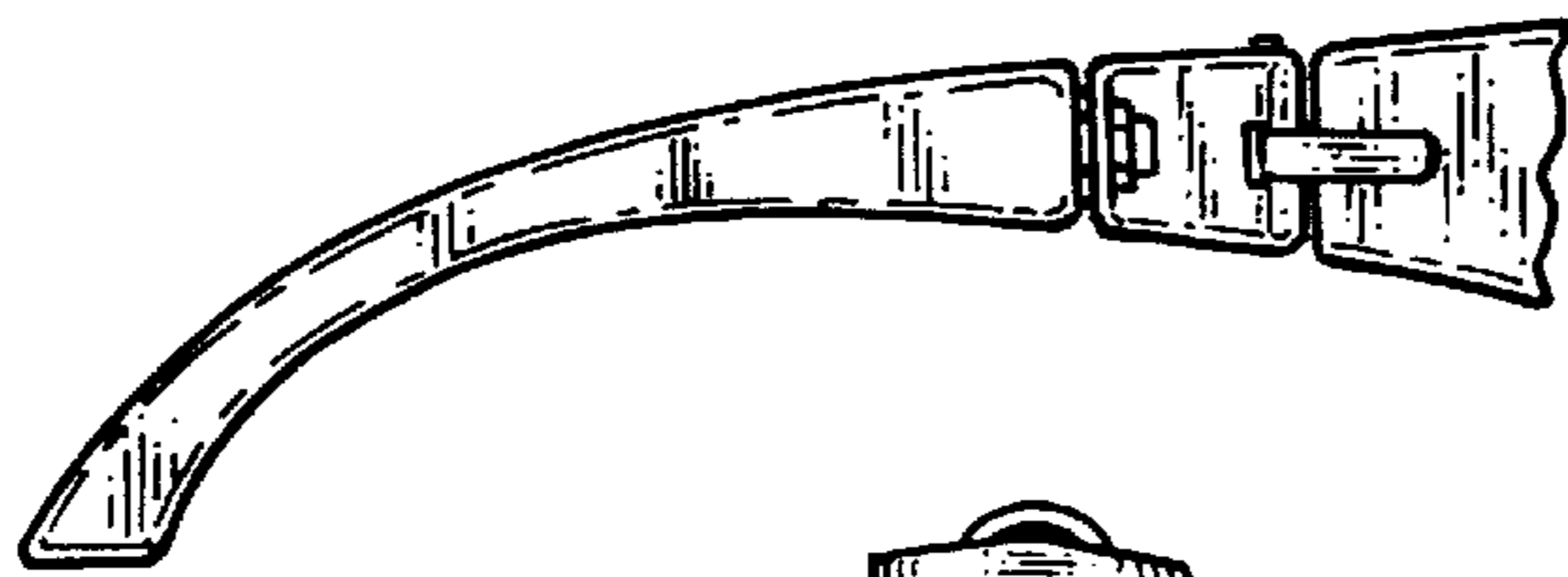

Fig. 6

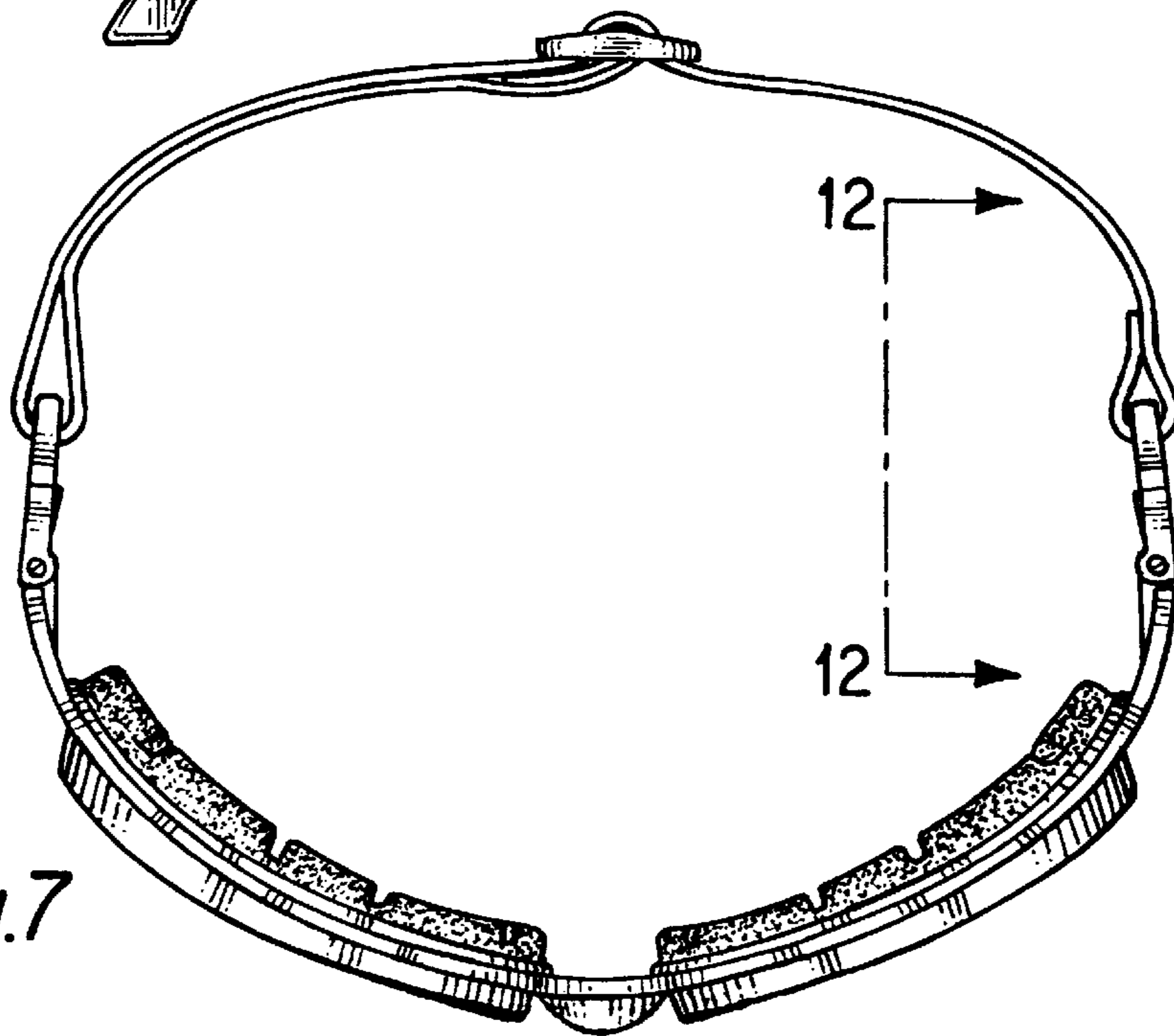

Fig. 7

Fig.8

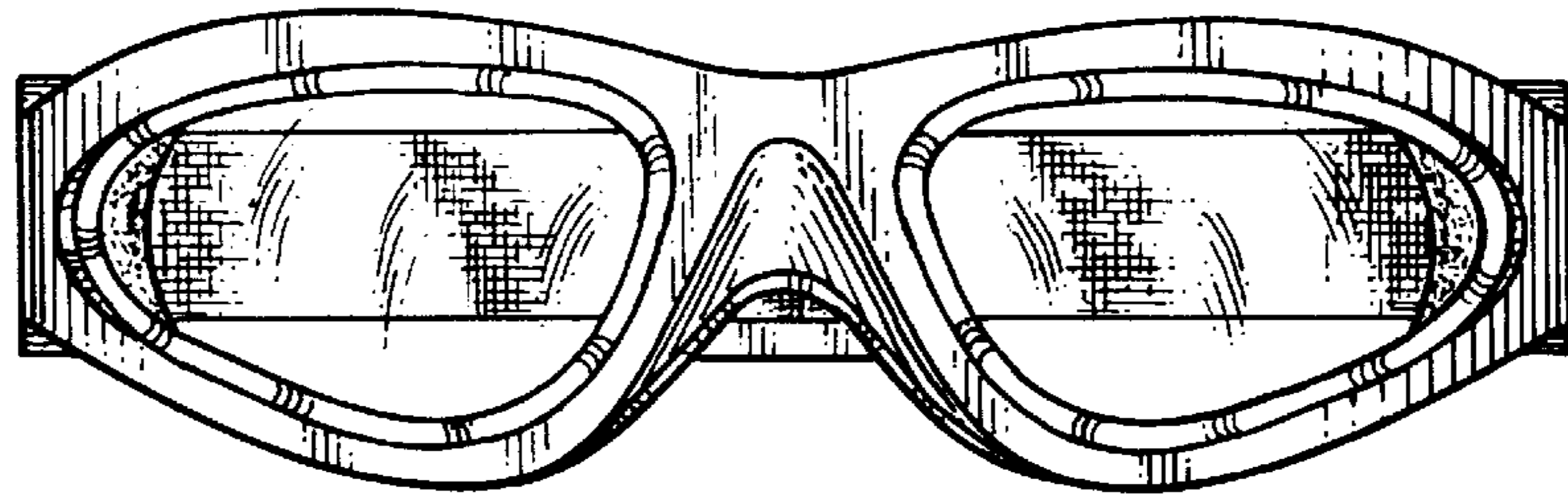

Fig.9

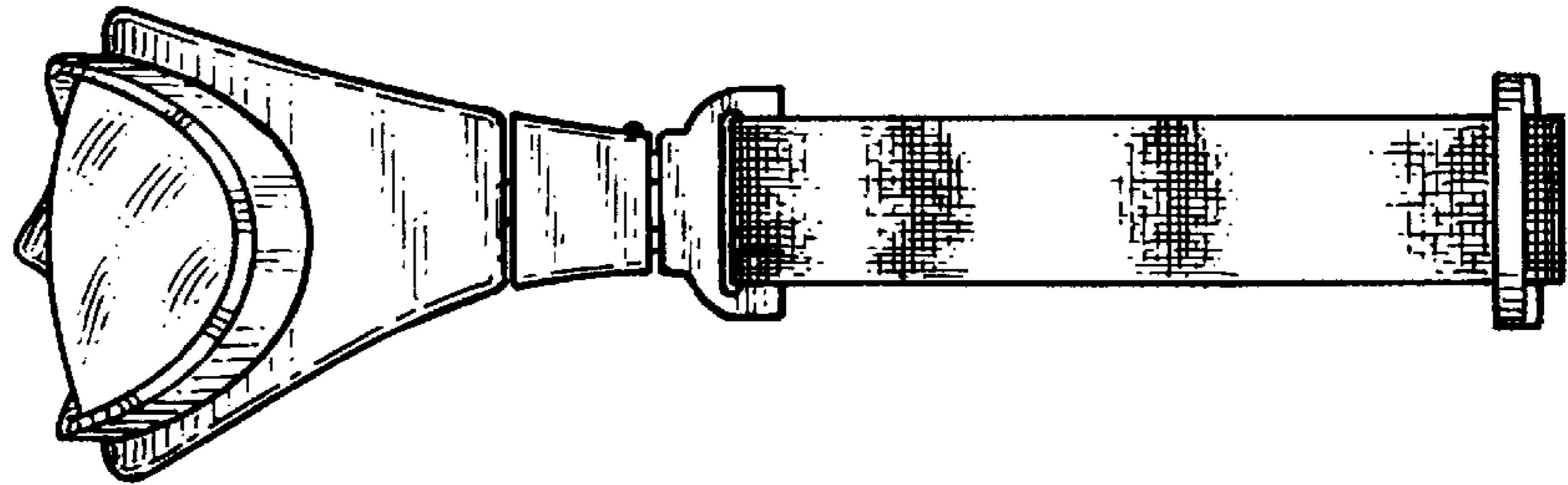

Fig.10

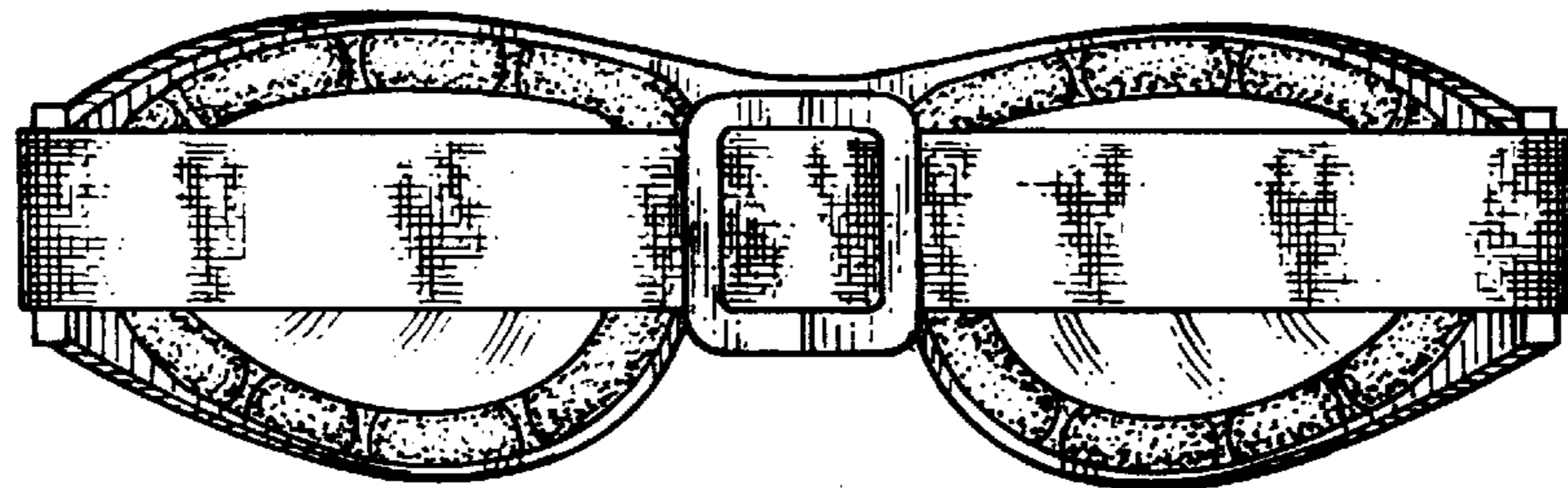

Fig.11

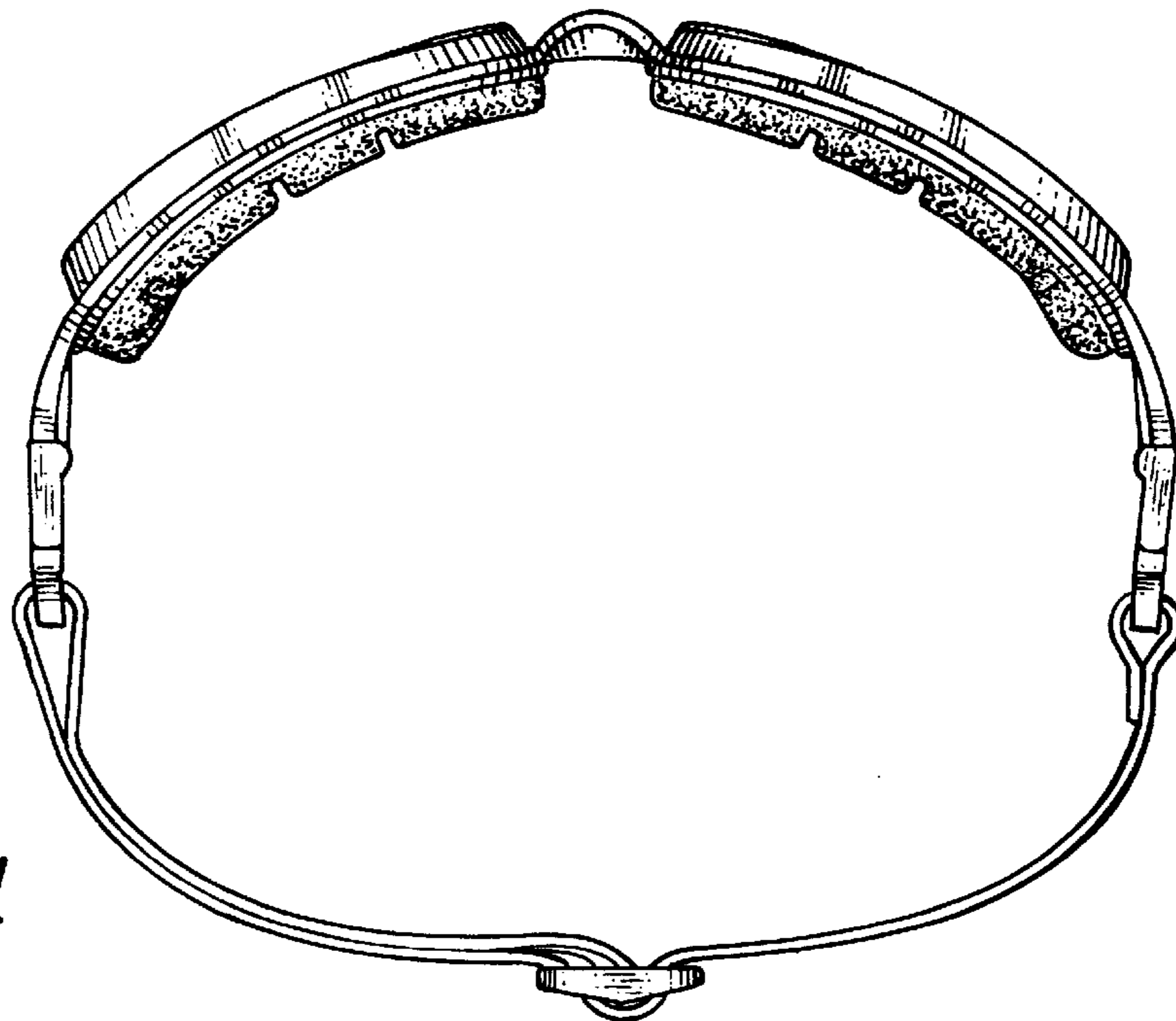

Fig.12

