



US00D467180S

(12) **United States Design Patent**
Clochet

(10) **Patent No.:** **US D467,180 S**

(45) **Date of Patent:** **** Dec. 17, 2002**

(54) **BOTTLE**

(75) Inventor: **Jean Clochet**, Chambéry le Vieux (FR)

(73) Assignee: **Routin S.A.**, Chambéry (FR)

(**) Term: **14 Years**

(21) Appl. No.: **29/099,561**

(22) Filed: **Jan. 22, 1999**

(30) **Foreign Application Priority Data**

Jul. 24, 1998 (FR) 984386

(51) **LOC (7) Cl.** **09-01**

(52) **U.S. Cl.** **D9/506; D9/516; D9/560;**
D9/564; D9/574

(58) **Field of Search** D9/300, 302, 500,
D9/502-504, 506, 510, 511, 516, 520, 529-530,
533, 545, 549, 551, 556, 560, 544, 564,
571, 572, 575; 215/370, 378, 379; 220/674

(56) **References Cited**

U.S. PATENT DOCUMENTS

- 152,168 A * 6/1874 Renwick 220/674
- RE10,969 E * 11/1888 Storm 215/370
- D30,760 S * 5/1899 Lowrey D9/544
- D143,586 S * 1/1946 Green D9/533
- 3,648,884 A * 3/1972 Mansolino 220/673
- D226,705 S * 4/1973 Zundel D9/506
- 4,952,134 A * 8/1990 Bartley et al. 215/370
- D320,155 S * 9/1991 Plochman, III et al. D9/520

- D342,141 S * 12/1993 Baxter D9/502
- D364,568 S * 11/1995 Ishimoto D9/502
- D436,538 S * 1/2001 Lang D9/503

OTHER PUBLICATIONS

British Design Registration No. 1030133, Registration Date May 17, 1985, Proprietor Windett, Primary Locarno Class 9-01-03B, Viewed on Internet at the UK Patent Office Web Site.*

* cited by examiner

Primary Examiner—Ted Shooman

Assistant Examiner—Carol Rademaker

(74) *Attorney, Agent, or Firm*—Gray Cary Ware & Freidenrich LLP

(57) **CLAIM**

I claim the ornamental design for a bottle, as shown and described.

DESCRIPTION

FIG. 1 is a perspective view of a bottle showing my new design.

FIG. 2 is a side view of the bottle viewed from the right side corner of FIG. 1.

FIG. 3 is a front view of the bottle of FIG. 1.

FIG. 4 is a rear view of the bottle of FIG. 1.

FIG. 5 is a top plan view of the bottle of FIG. 1; and,

FIG. 6 is a bottom plan view of the bottle of FIG. 1.

1 Claim, 2 Drawing Sheets

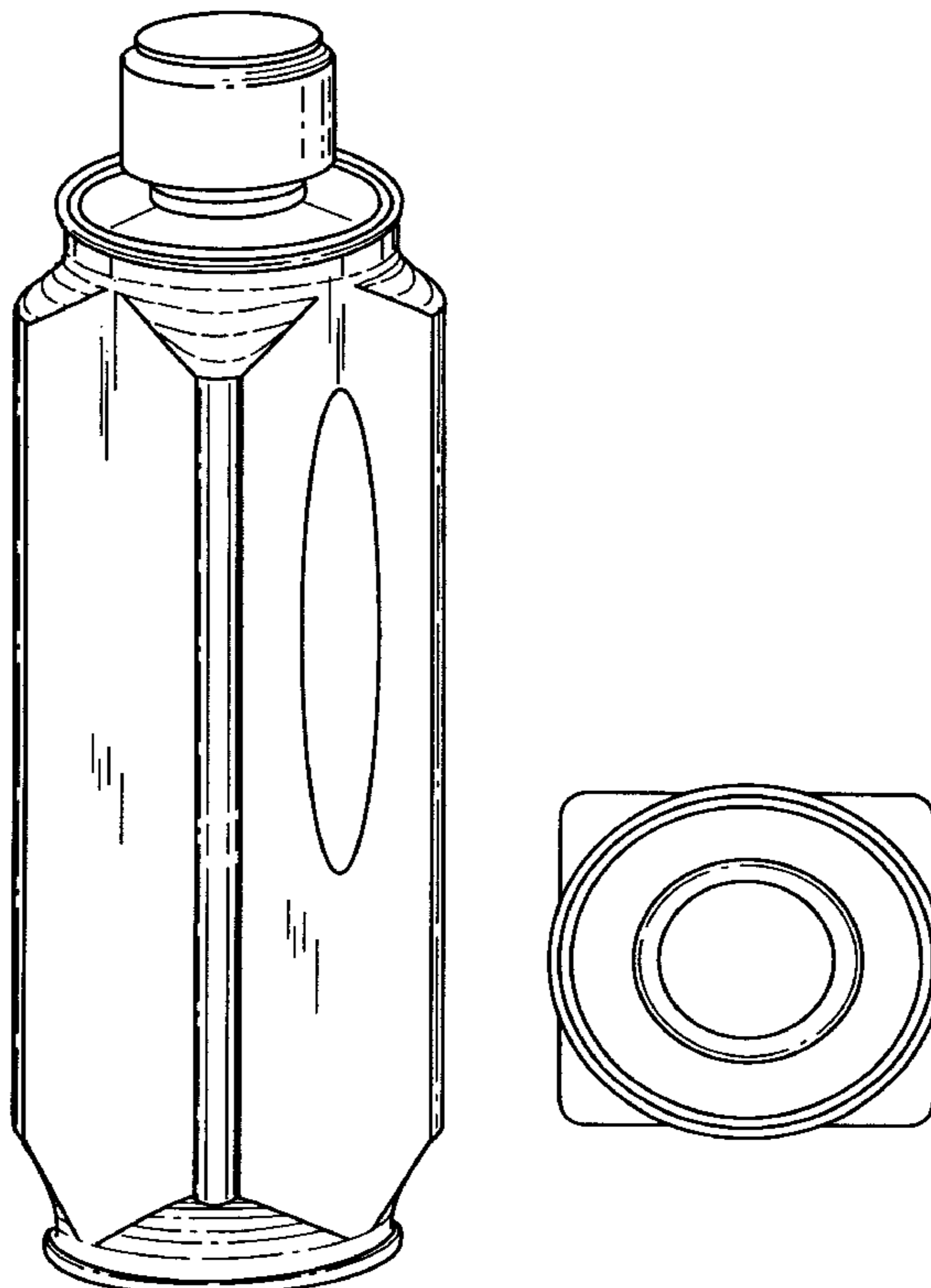

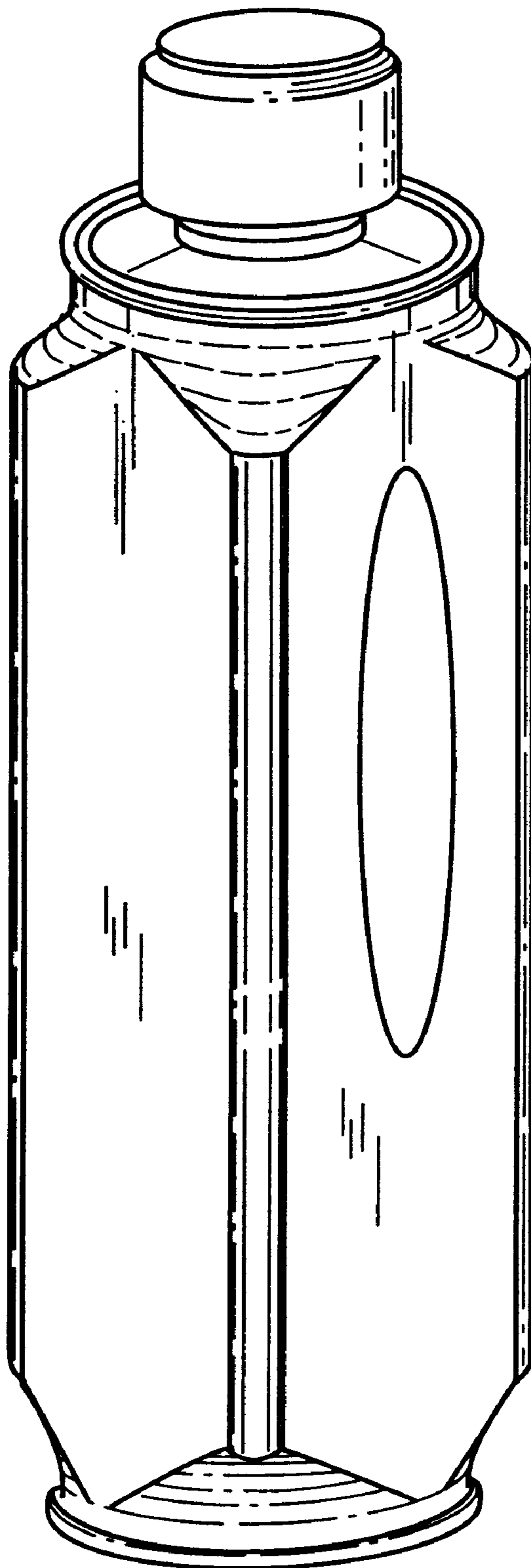

FIG. 1

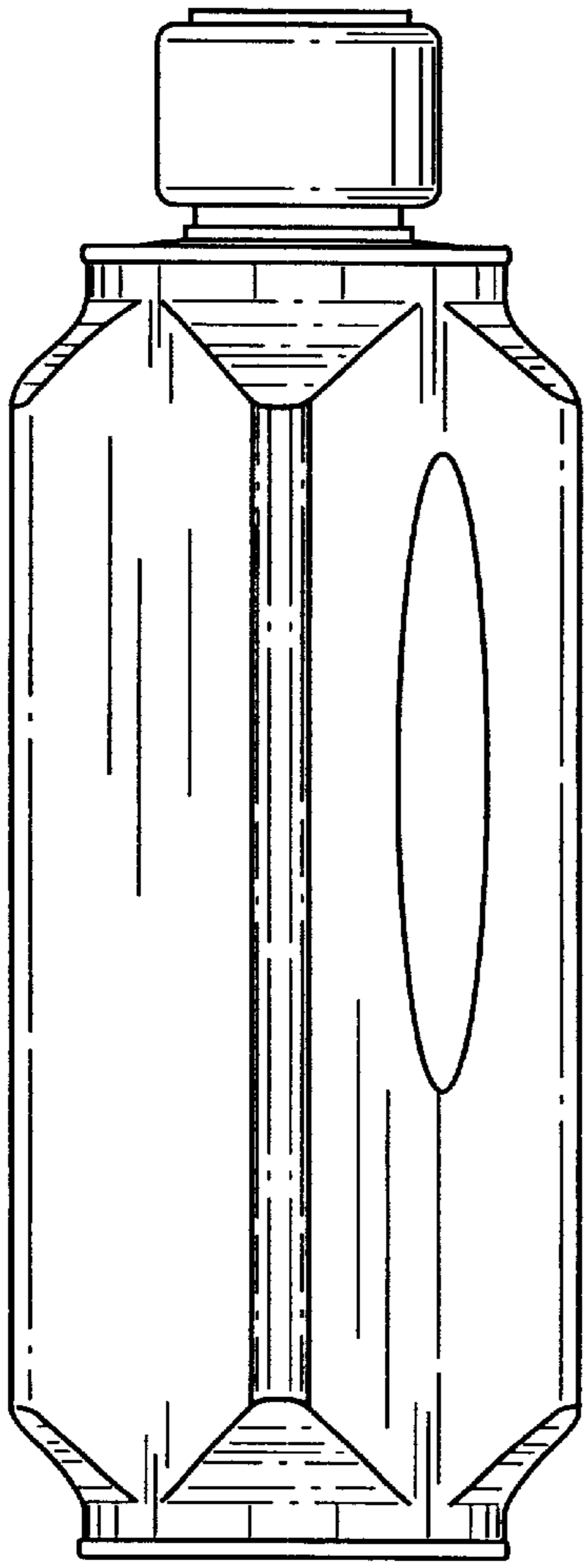

FIG. 2

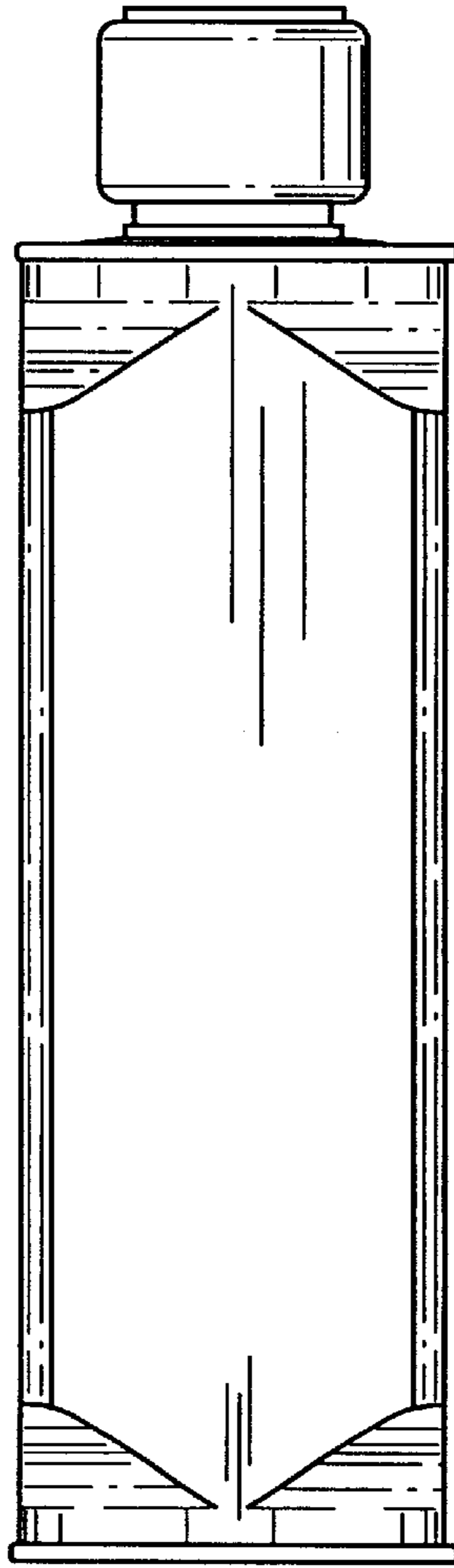

FIG. 3

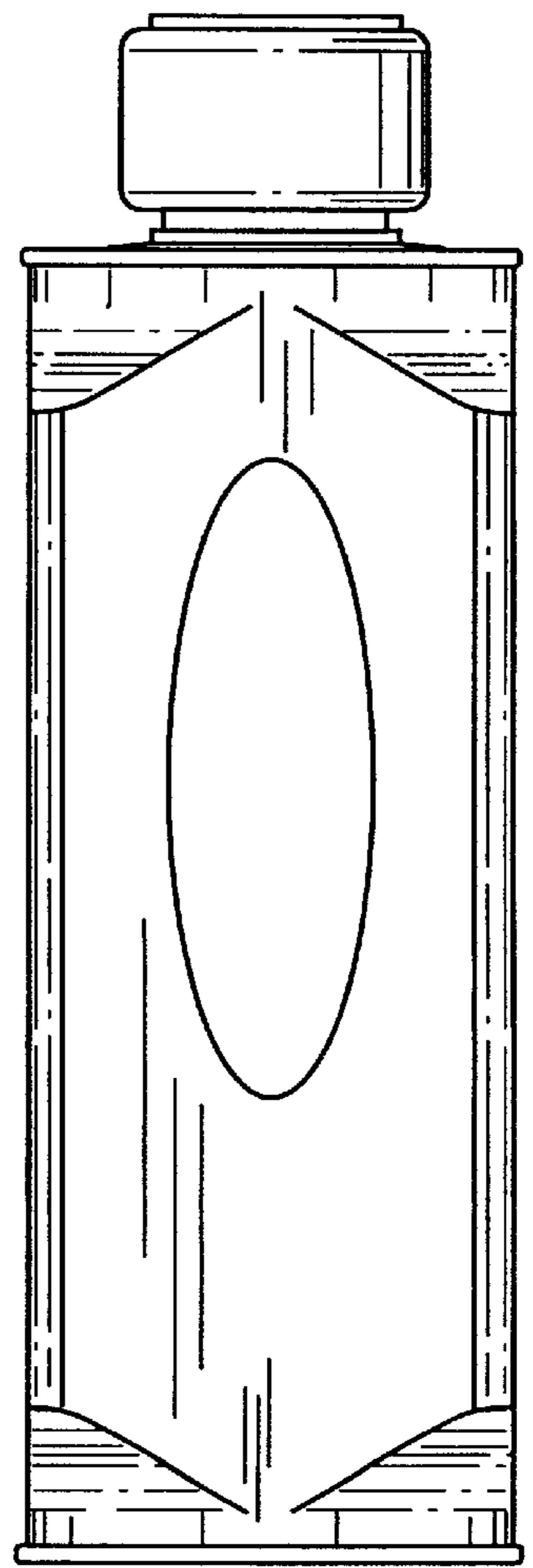

FIG. 4

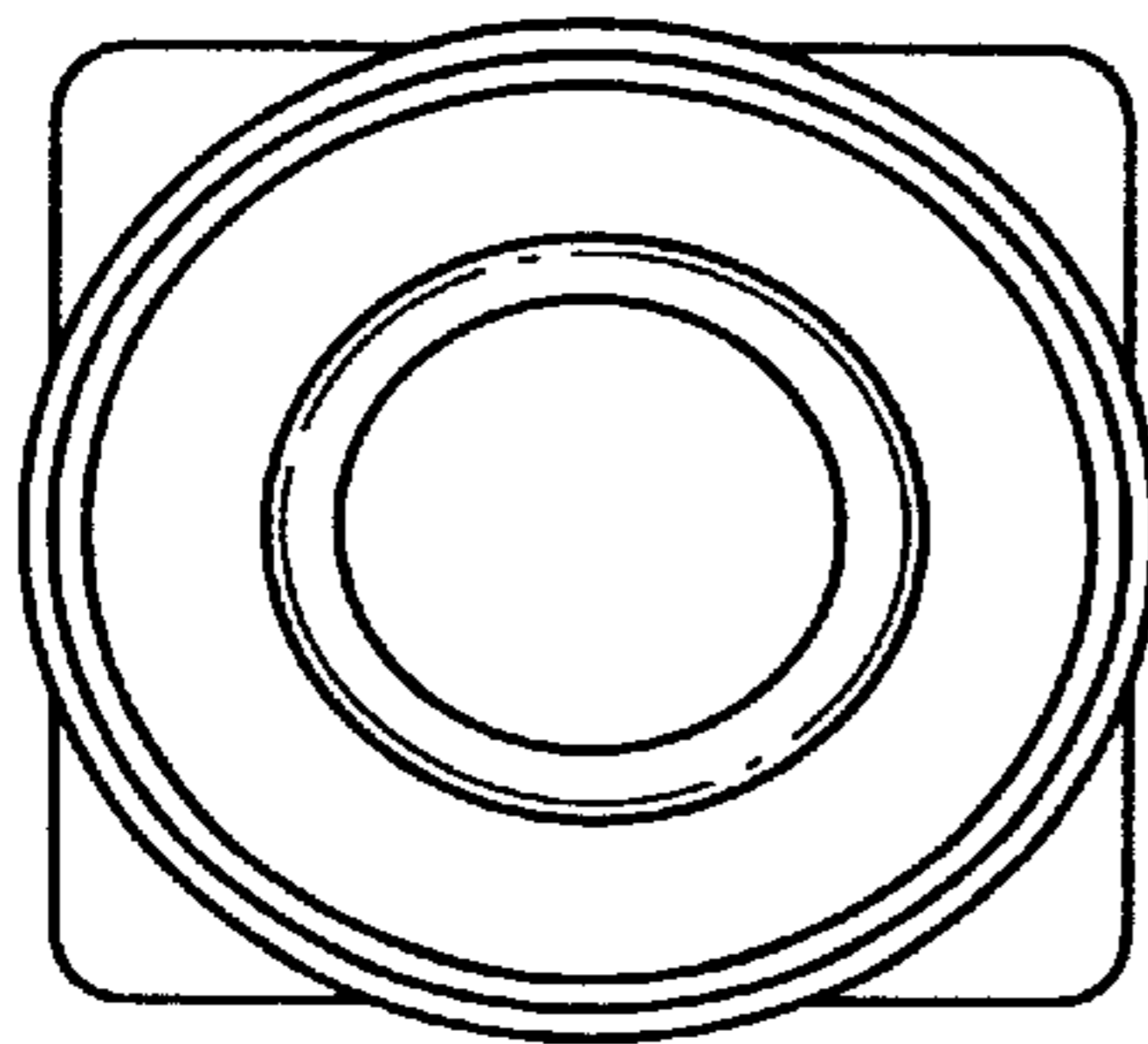

FIG. 5

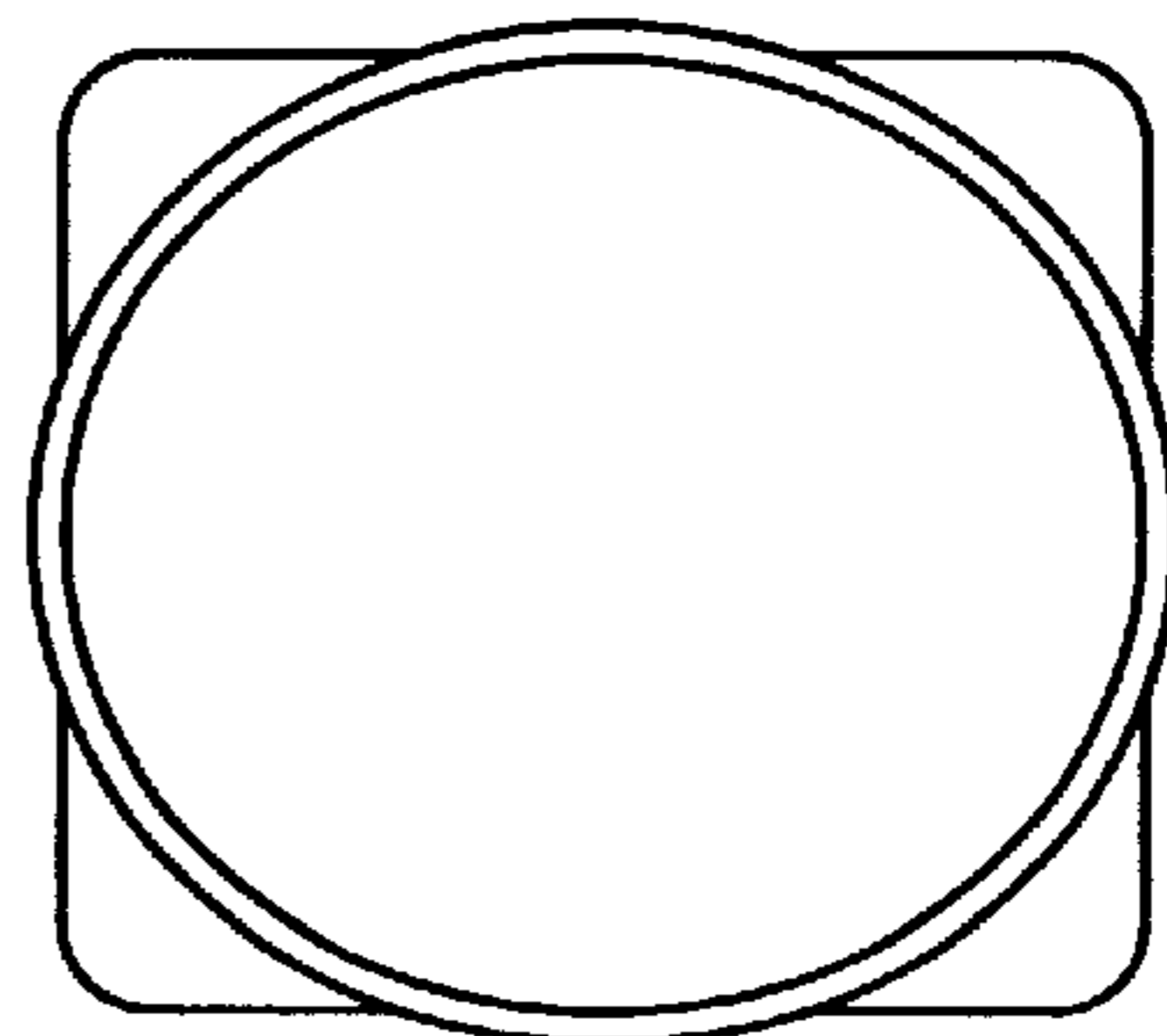

FIG. 6