



US00D467172S

(12) **United States Design Patent**
Thompson et al.

(10) **Patent No.: US D467,172 S**

(45) **Date of Patent: ** Dec. 17, 2002**

(54) **PACKAGING FOR PENS OR THE LIKE**

(57) **CLAIM**

(75) Inventors: **Eric E. Thompson**, Costa Mesa, CA (US); **Craig Carroll**, Anaheim Hills, CA (US)

The ornamental design for packaging for pens or the like, as shown and described.

DESCRIPTION

(73) Assignee: **Avery Dennison Corporation**, Pasadena, CA (US)

FIG. 1 is a front elevational view of a packaging for pens or the like showing our new design;

(**) Term: **14 Years**

FIG. 2 is a left side elevational view thereof; the right side elevational view being a mirror image thereof;

(21) Appl. No.: **29/147,083**

FIG. 3 is a top plan view thereof; the bottom plan view being a mirror image thereof;

(22) Filed: **Aug. 21, 2001**

FIG. 4 is a rear elevational view thereof;

(51) **LOC (7) Cl.** **09-03**

FIG. 5 is an enlarged scale sectional view taken along line 5—5 of FIG. 1;

(52) **U.S. Cl.** **D9/415; D9/418**

FIG. 6 is a front elevational view of a first embodiment of FIG. 1;

(58) **Field of Search** D9/415, 418, 337, D9/457; 206/461—471, 214, 215, 575, 806, 495; D19/35, 36, 41

FIG. 7 is a left side elevational view of FIG. 6;

FIG. 8 is a top plan view of FIG. 6; the bottom plan view being a mirror image thereof;

(56) **References Cited**

U.S. PATENT DOCUMENTS

2,170,906	A	*	8/1939	Mertz	206/214
2,521,184	A	*	9/1950	Paige	206/776
2,872,030	A	*	2/1959	Dumomt	206/214
2,931,495	A	*	4/1960	Stratton	206/214 X
3,927,762	A	*	12/1975	Zdarsky et al.	206/462
5,082,112	A	*	1/1992	Dunklee	206/471 X
D400,435	S	*	11/1998	Appelbaum	D9/418
D400,790	S	*	11/1998	Appelbaum	D9/418
6,196,388	B1	*	3/2001	Kaposvari	206/214

FIG. 9 is a right side elevational view of FIG. 6;

FIG. 10 is a rear elevational view of FIG. 6;

FIG. 11 is an enlarged scale sectional view taken along line 11—11 of FIG. 6;

FIG. 12 is a front elevational view of a second embodiment of FIG. 1;

FIG. 13 is a left side elevational view of FIG. 12;

FIG. 14 is a top plan view of FIG. 11; the bottom plan view being a mirror image thereof;

FIG. 15 is a right side elevational view of FIG. 11;

FIG. 16 is a rear elevational view of FIG. 11; and,

FIG. 17 is an enlarged scale sectional view taken along line 17—17 of FIG. 12.

* cited by examiner

The broken line showing of pens is for illustrative purpose only and forms no part of the claimed design.

Primary Examiner—Prabhakar Deshmukh

(74) *Attorney, Agent, or Firm*—Oppenheimer Wolff & Donnelly LLP

1 Claim, 6 Drawing Sheets

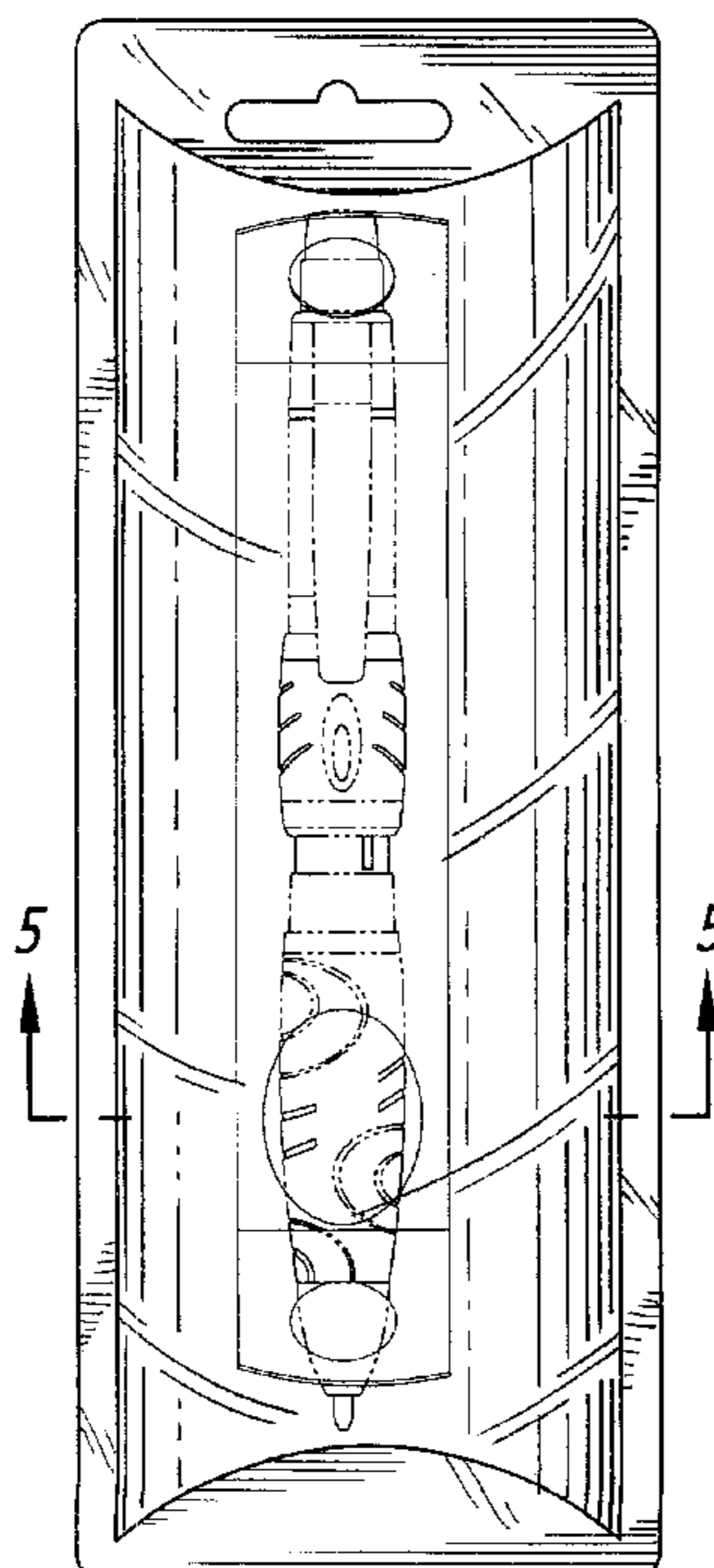

FIG. 3

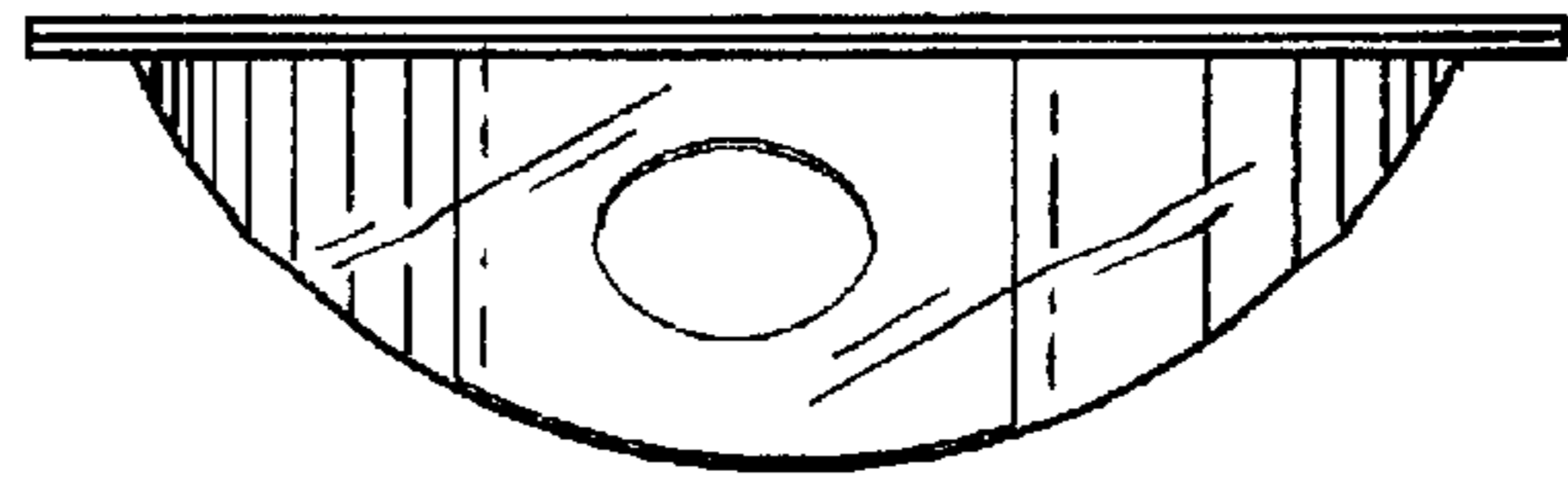

FIG. 1

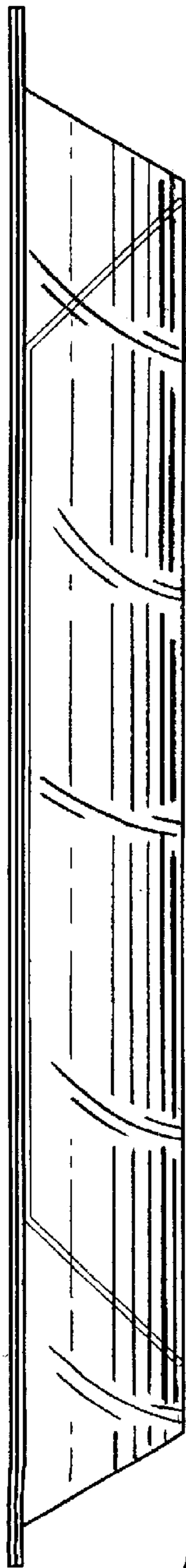
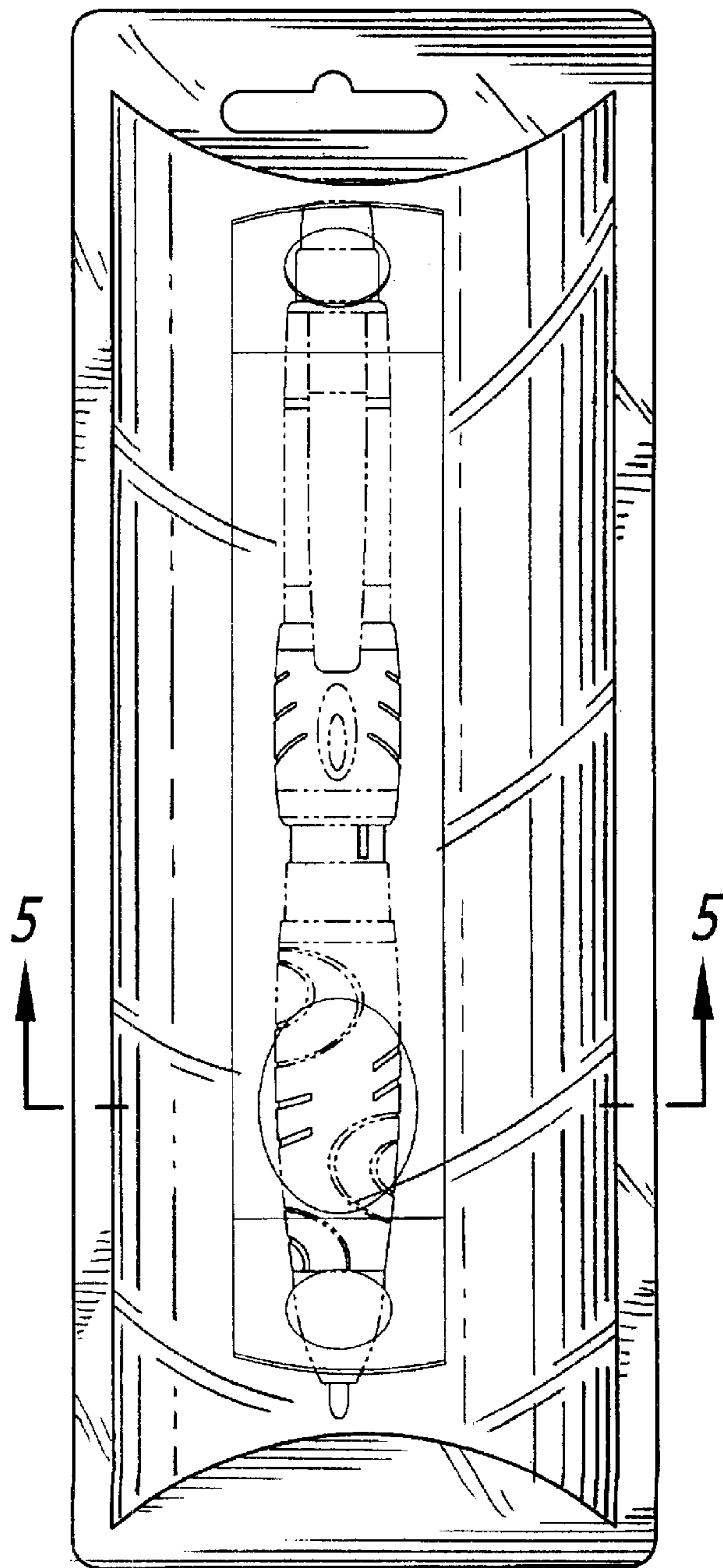

FIG. 2

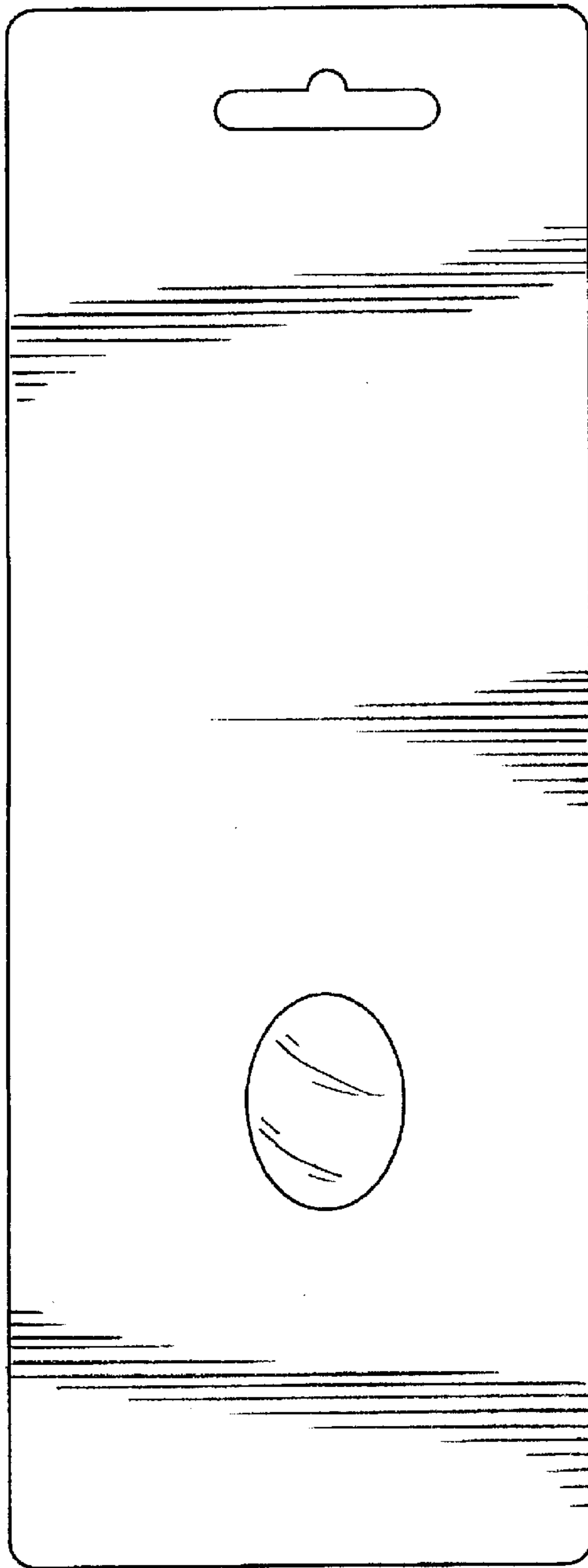

FIG. 4

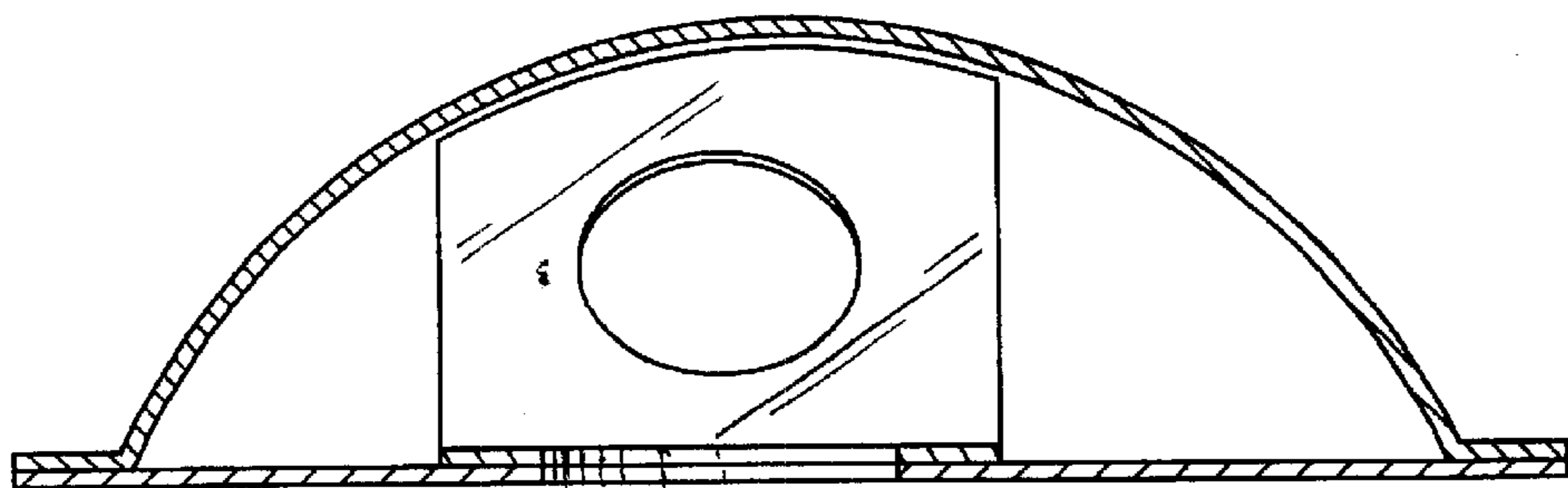

FIG. 5

FIG. 8

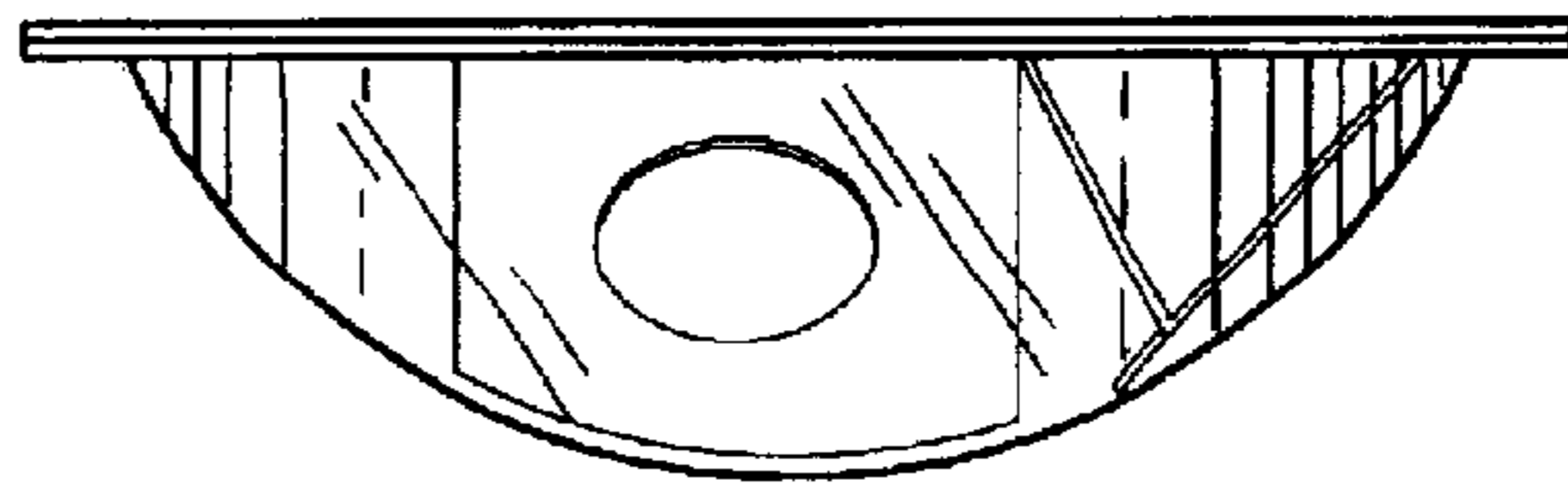

FIG. 6

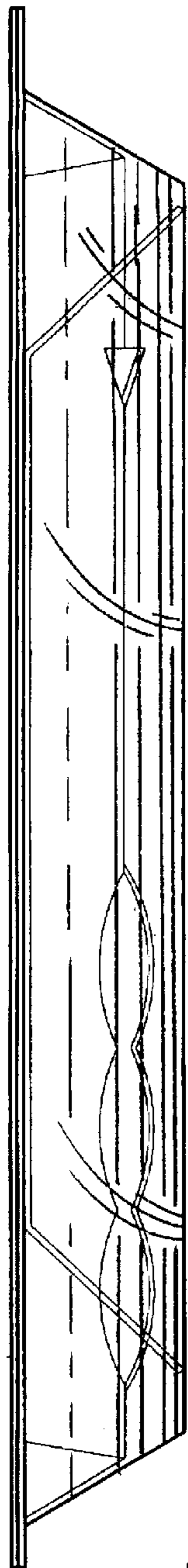
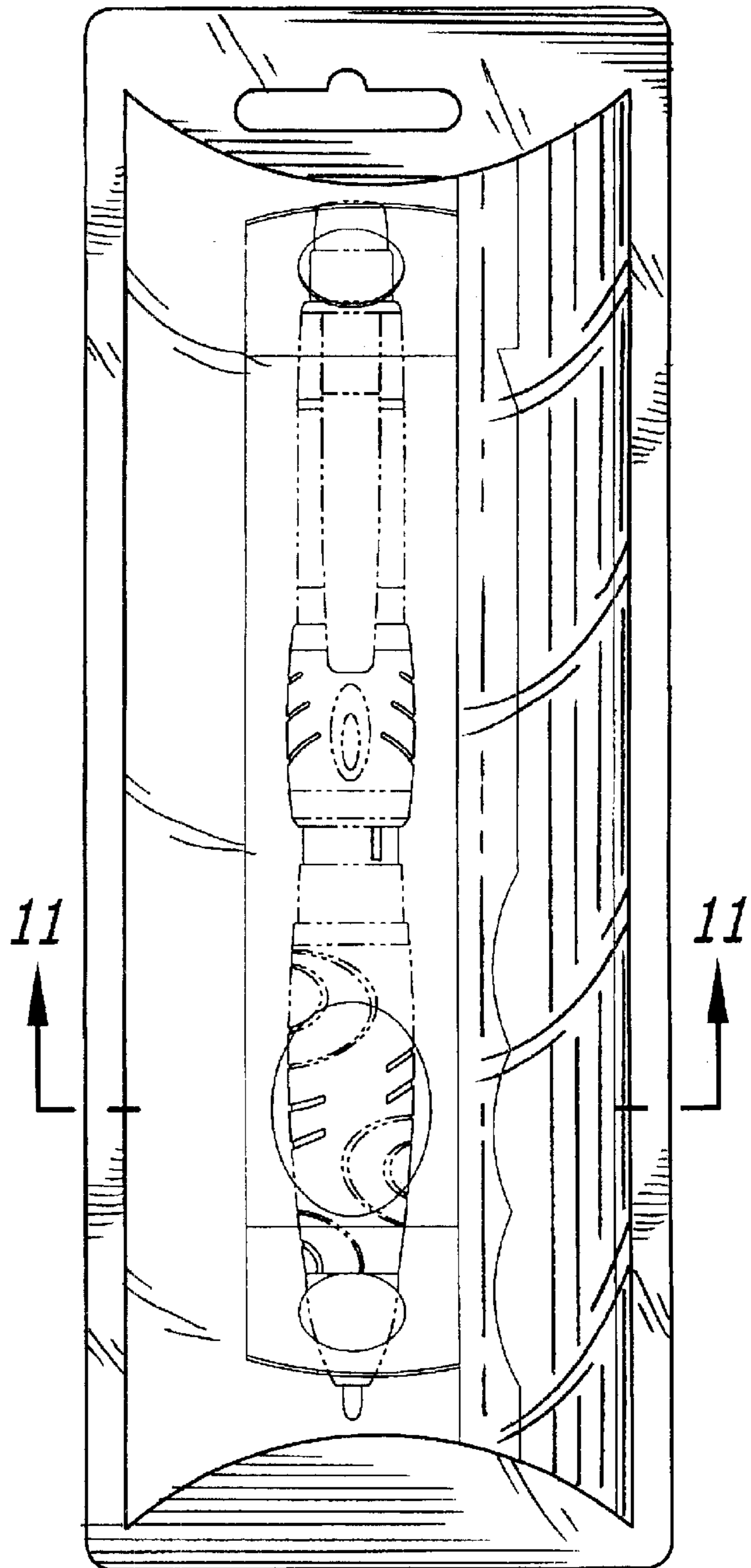

FIG. 7

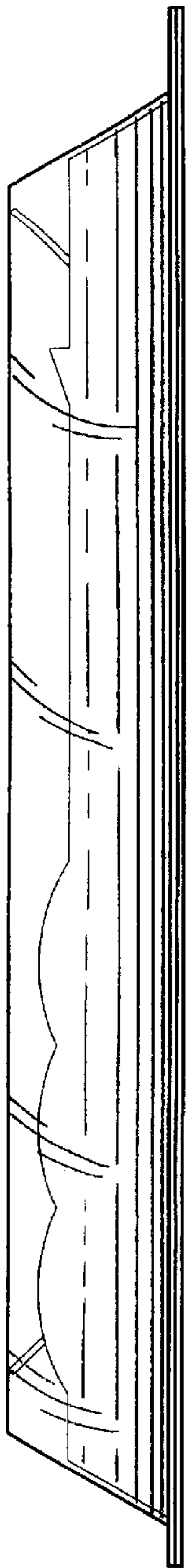

FIG. 9

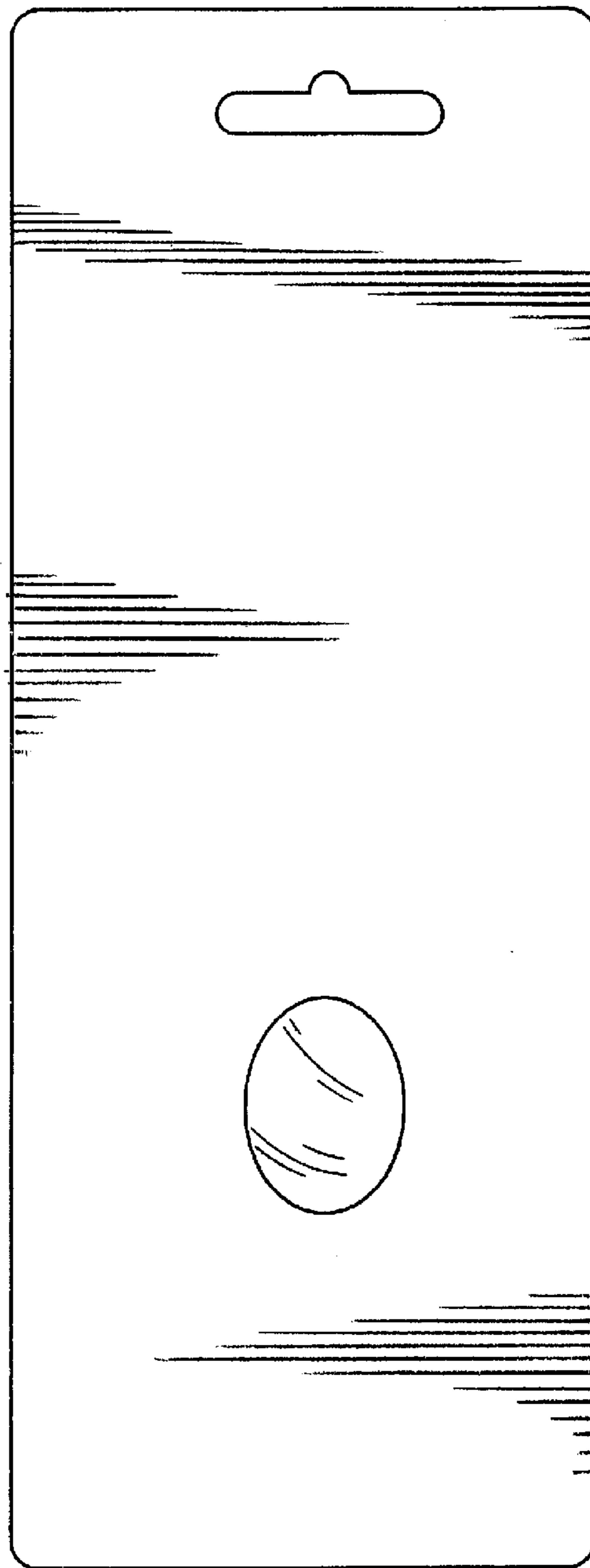

FIG. 10

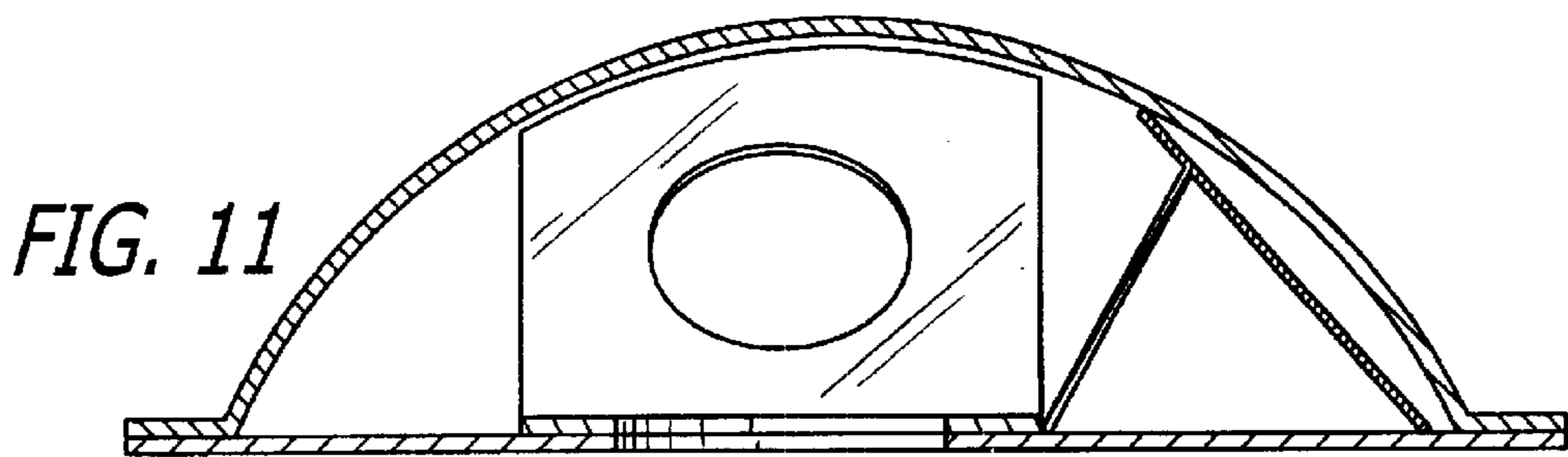

FIG. 11

FIG. 14

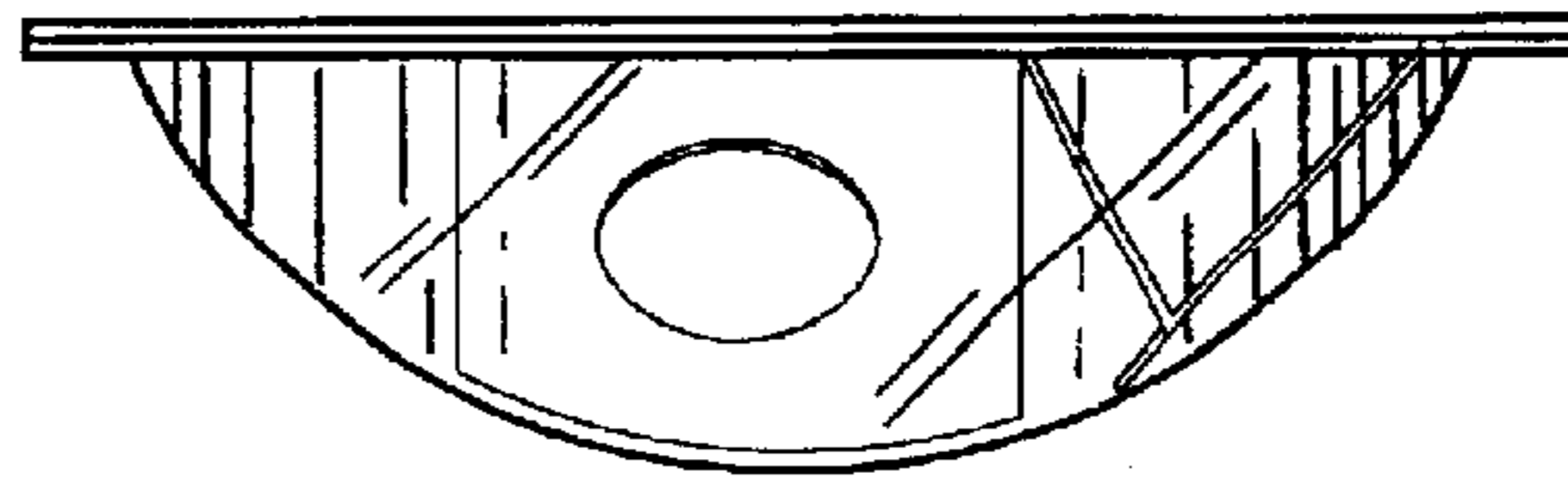

FIG. 12

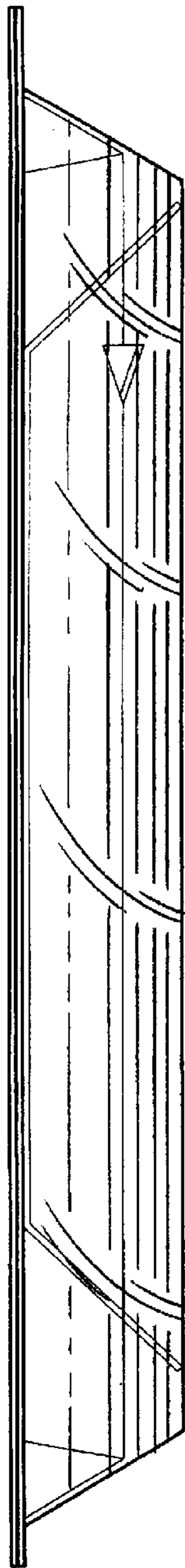
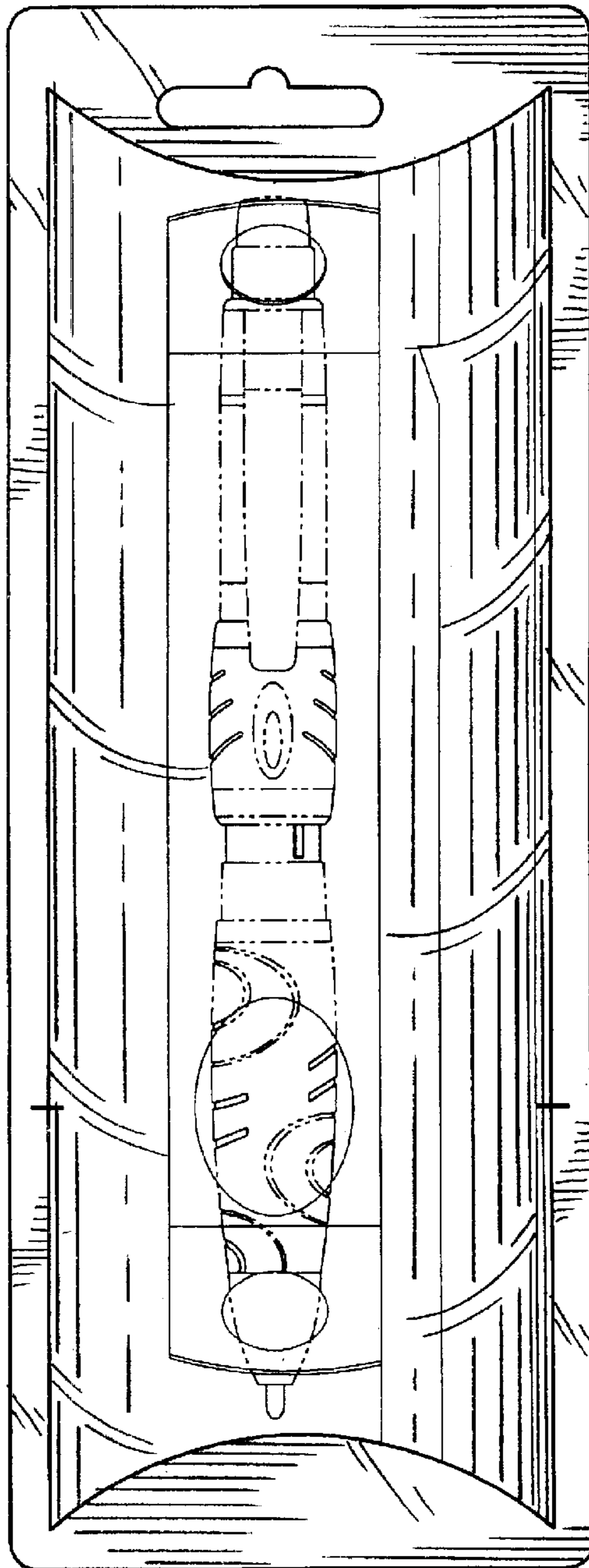

FIG. 13

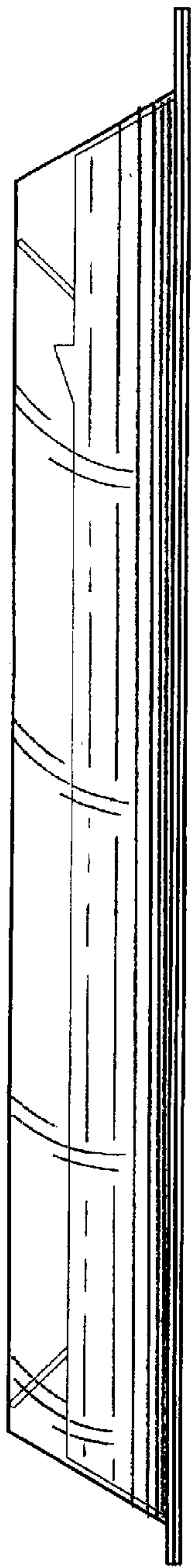

FIG. 15

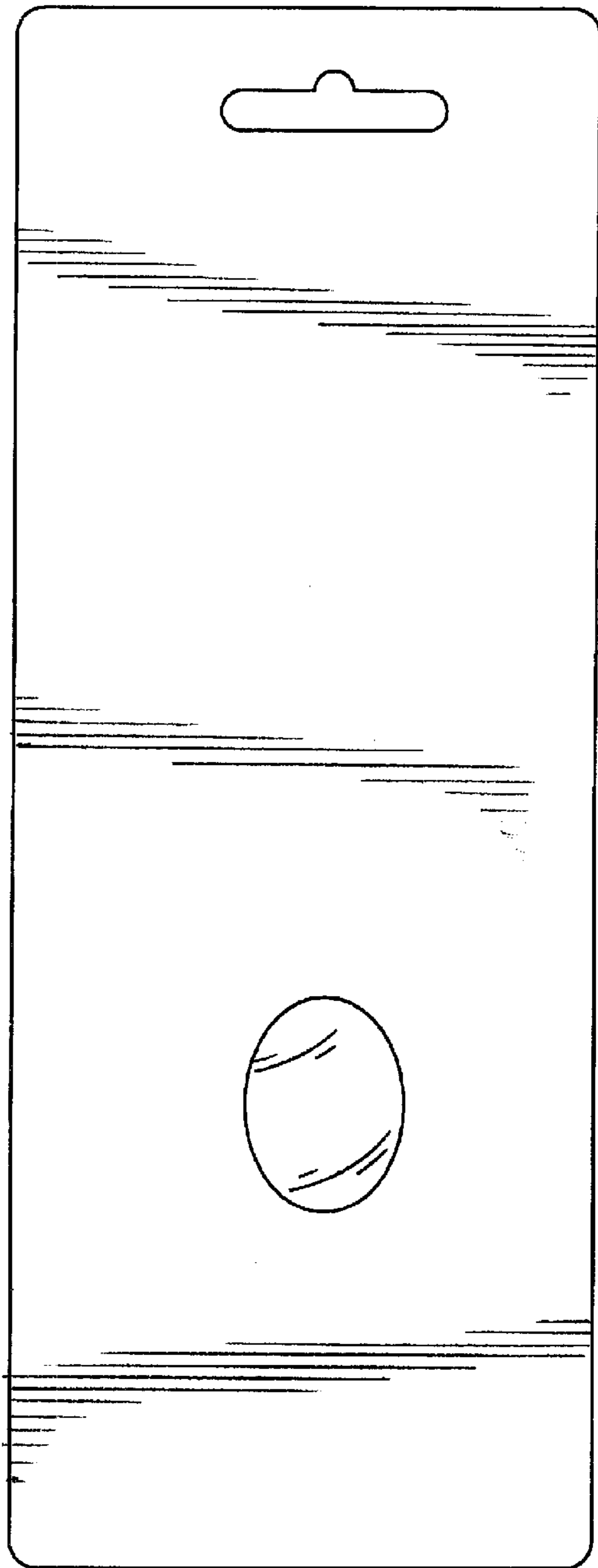

FIG. 16

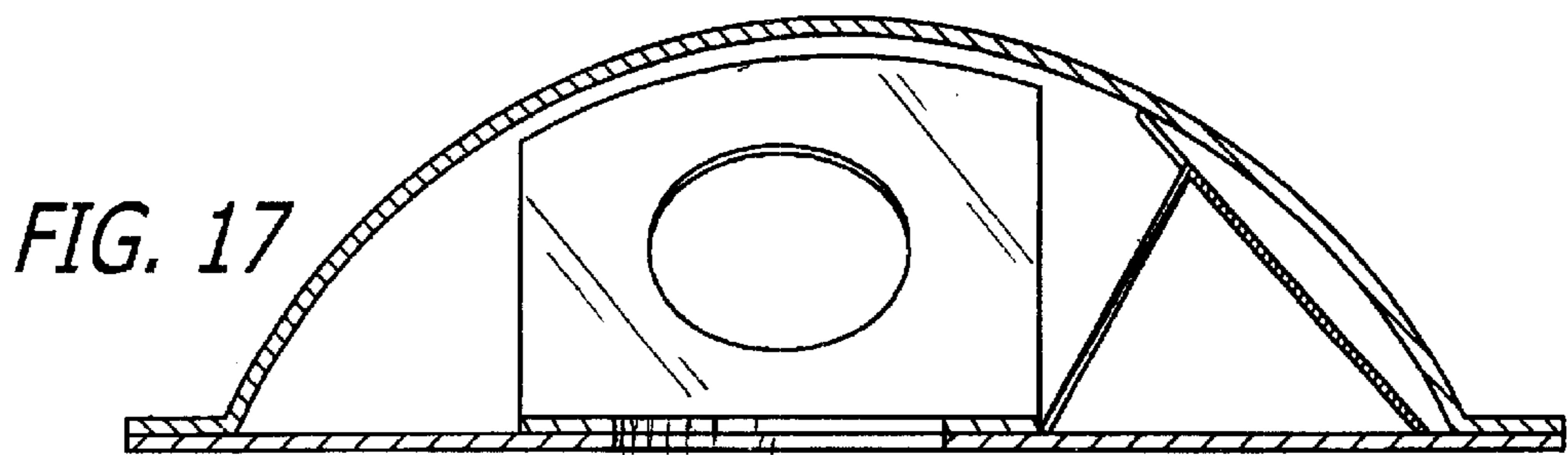

FIG. 17