



US00D467137S

(12) **United States Design Patent**
Gross

(10) **Patent No.:** **US D467,137 S**

(45) **Date of Patent:** **** Dec. 17, 2002**

(54) **SPOON**

(75) Inventor: **Brett Gross**, Tarzana, CA (US)

(73) Assignee: **Alegacy Foodservice Products Group, Inc.**, Rancho Dominguez, CA (US)

(**) Term: **14 Years**

(21) Appl. No.: **29/152,797**

(22) Filed: **Dec. 27, 2001**

(51) **LOC (7) Cl.** **07-02**

(52) **U.S. Cl.** **D7/691; D7/692**

(58) **Field of Search** D7/395, 688, 691,
D7/692, 647-653, 664, 401.2; 30/323-325

(56) **References Cited**

U.S. PATENT DOCUMENTS

1,728,211	A	*	9/1929	McClellan	D7/688	X
3,964,161	A	*	6/1976	Wise	D7/691	X
D292,663	S	*	11/1987	Johnson	D7/691	
D307,095	S	*	4/1990	Juergens	D7/653	
D308,804	S	*	6/1990	Hiscott et al.	D7/653	
D332,579	S	*	1/1993	Goldman	D7/691	X
D402,167	S	*	12/1998	Durbin	D7/688	

* cited by examiner

Primary Examiner—Terry A. Wallace

(74) *Attorney, Agent, or Firm*—Oppenheimer Wolff & Donnelly LLP

(57) **CLAIM**

The ornamental design for a spoon, as shown and described.

DESCRIPTION

FIG. 1 is a side elevational view of a spoon showing my new design;

FIG. 2 is a front elevational view of the spoon of FIG. 1;

FIG. 3 is a rear elevational view of the spoon of FIG. 1;

FIG. 4 is an end view of the spoon of FIG. 1;

FIG. 5 is an end view of the spoon of FIG. 1 taken in the direction opposite that of FIG. 4;

FIG. 6 is a side elevational view of a second embodiment of a spoon showing my new design;

FIG. 7 is a front elevational view of the spoon of FIG. 6;

FIG. 8 is a rear elevational view of the spoon of FIG. 6;

FIG. 9 is an end view of the spoon of FIG. 6; and,

FIG. 10 is an end view of the spoon of FIG. 6 taken in the direction opposite to that of FIG. 9.

1 Claim, 2 Drawing Sheets

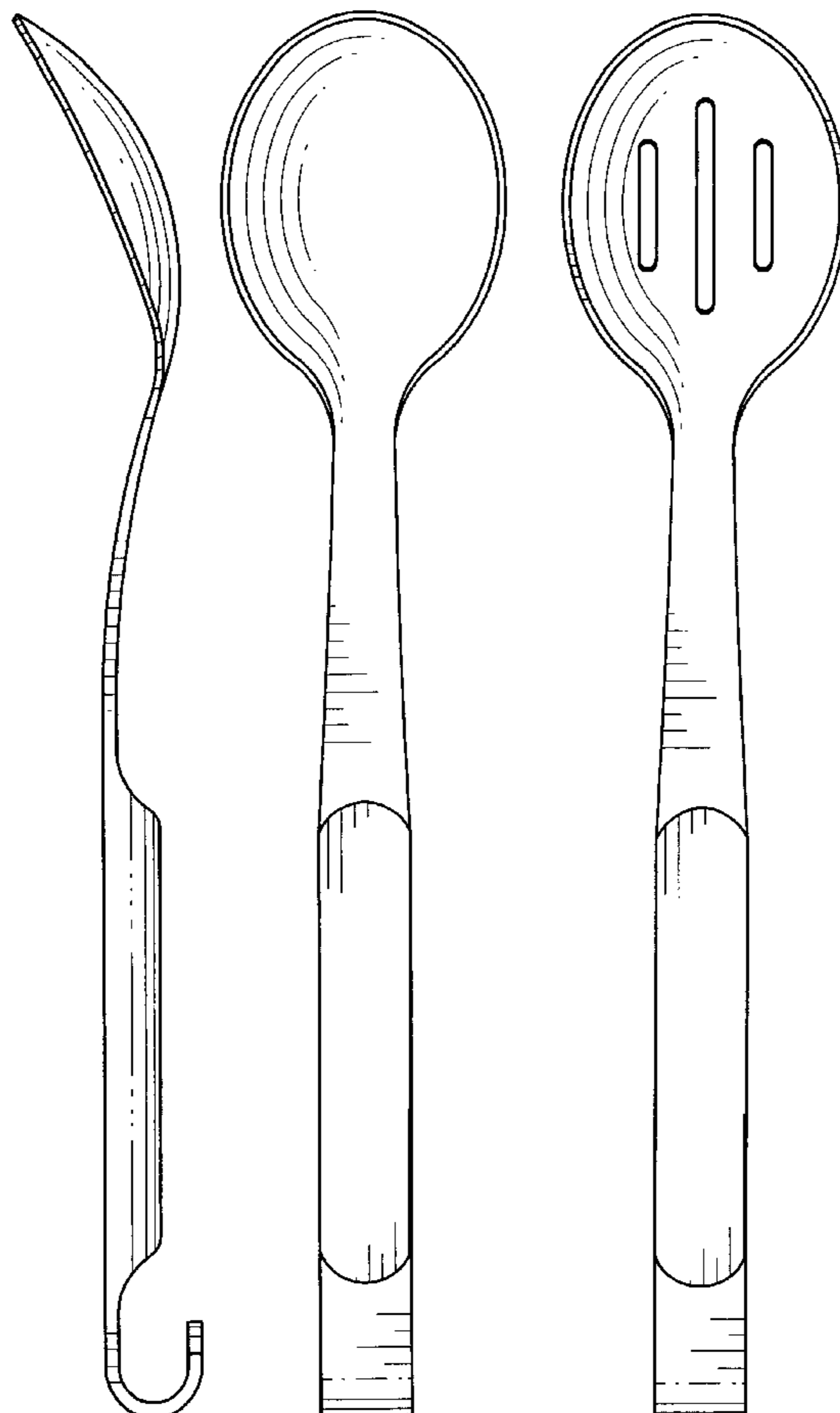

FIG. 1

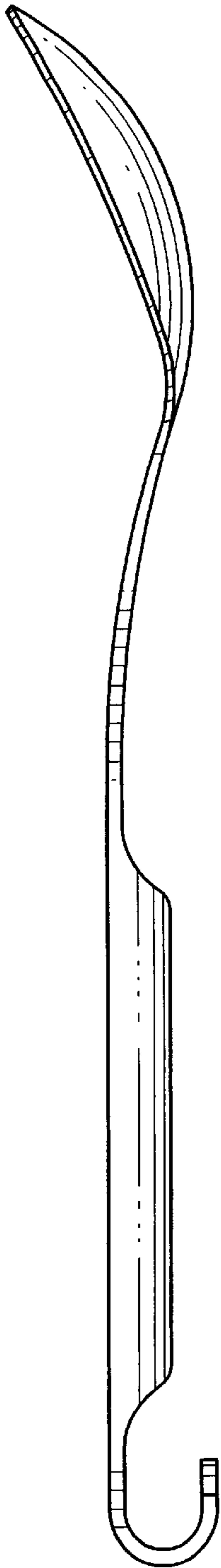

FIG. 2

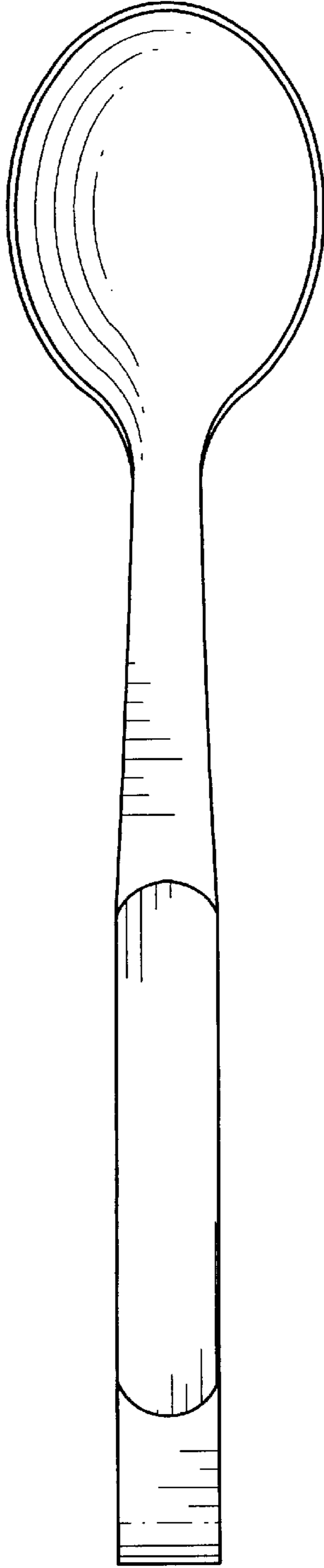

FIG. 3

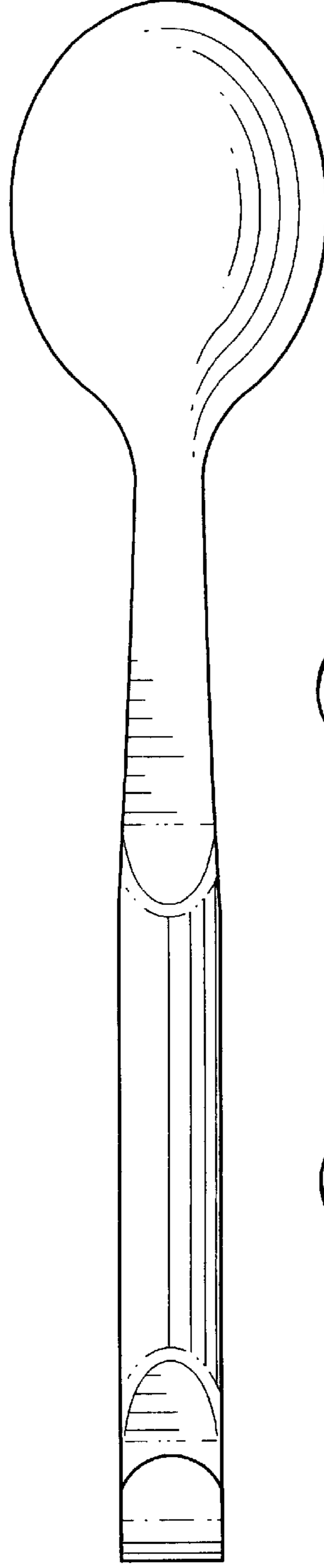

FIG. 4

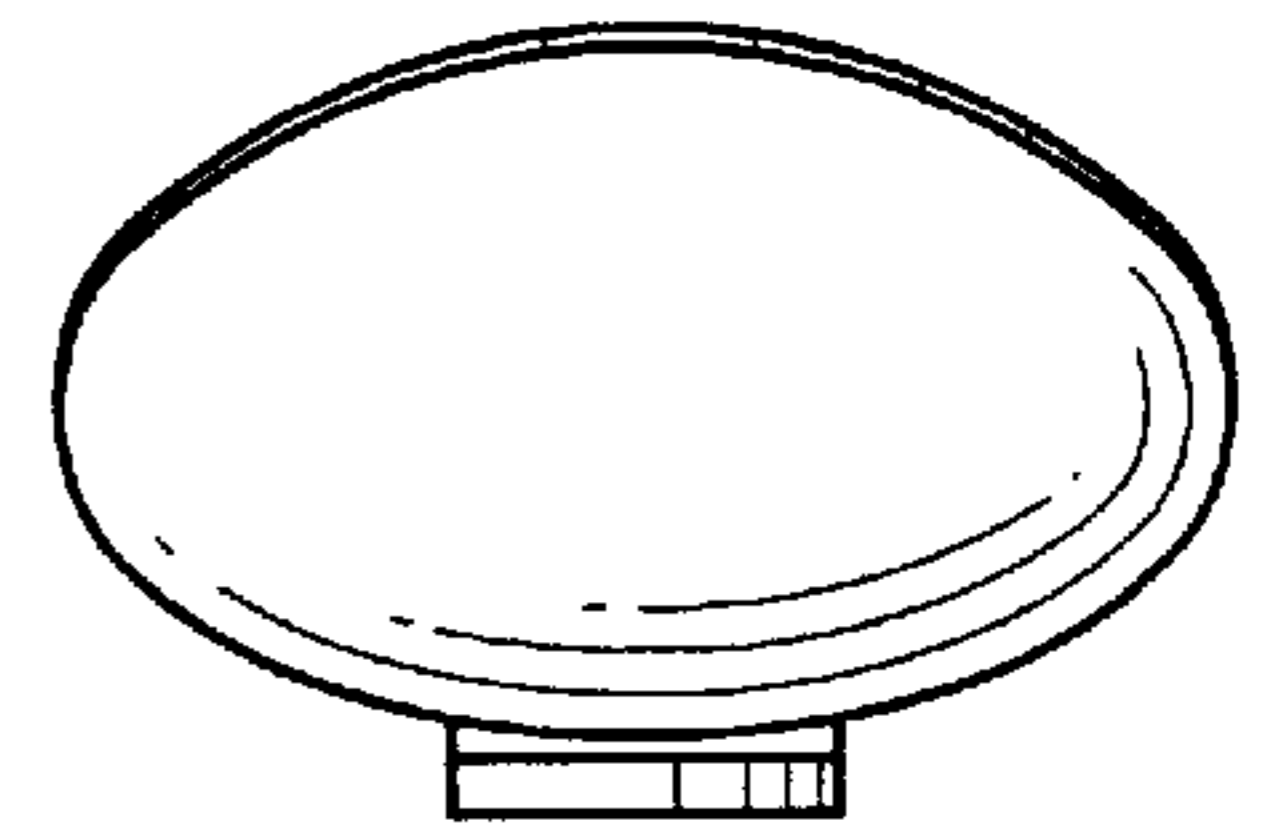

FIG. 5

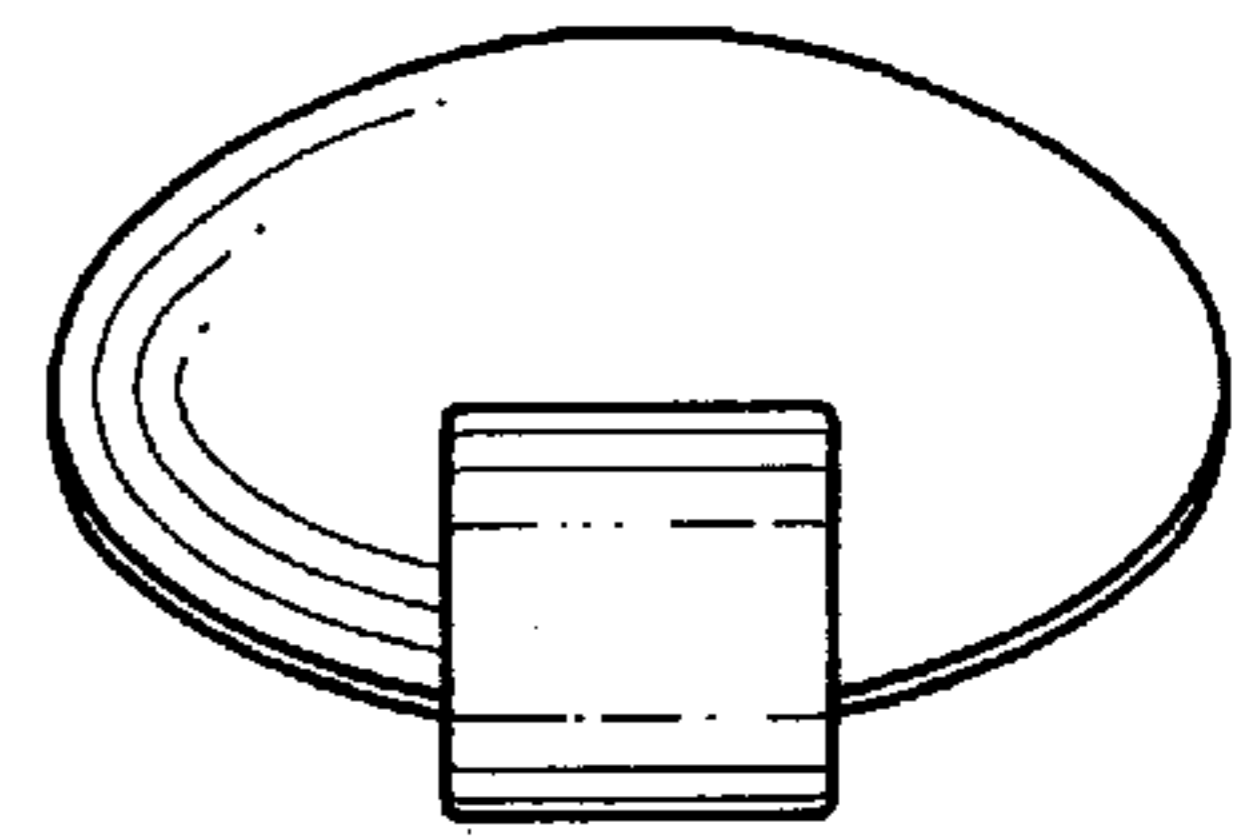

FIG. 6

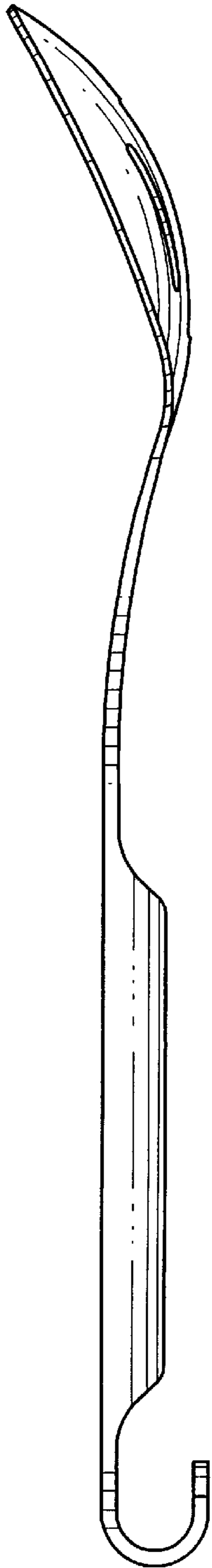

FIG. 7

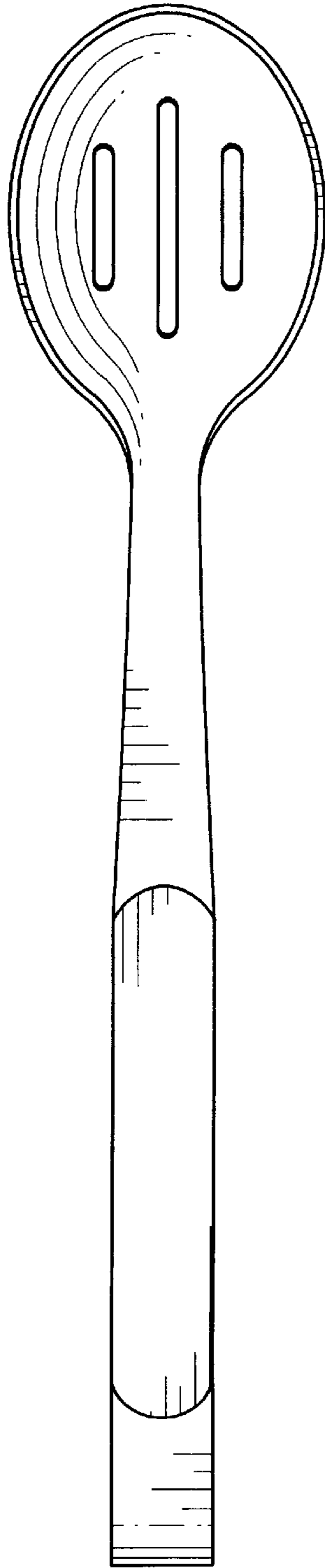

FIG. 8

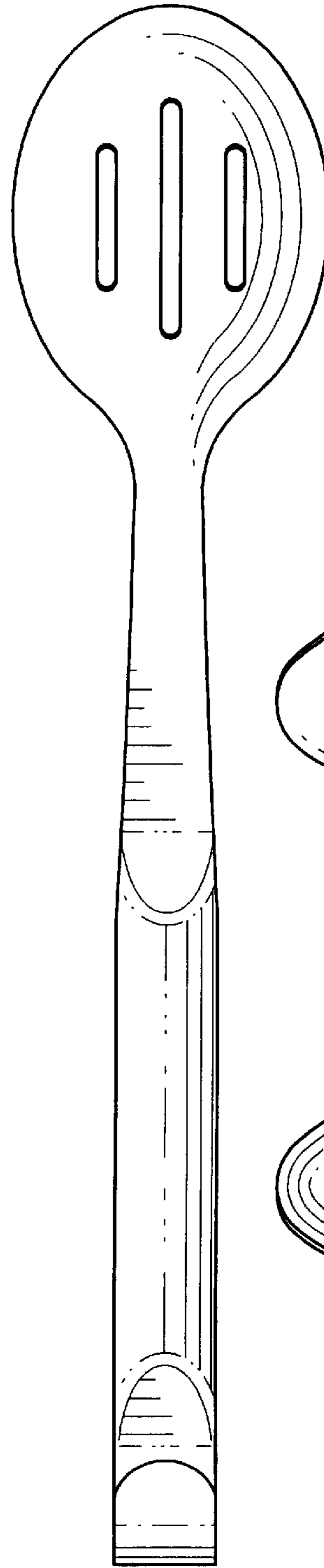

FIG. 9

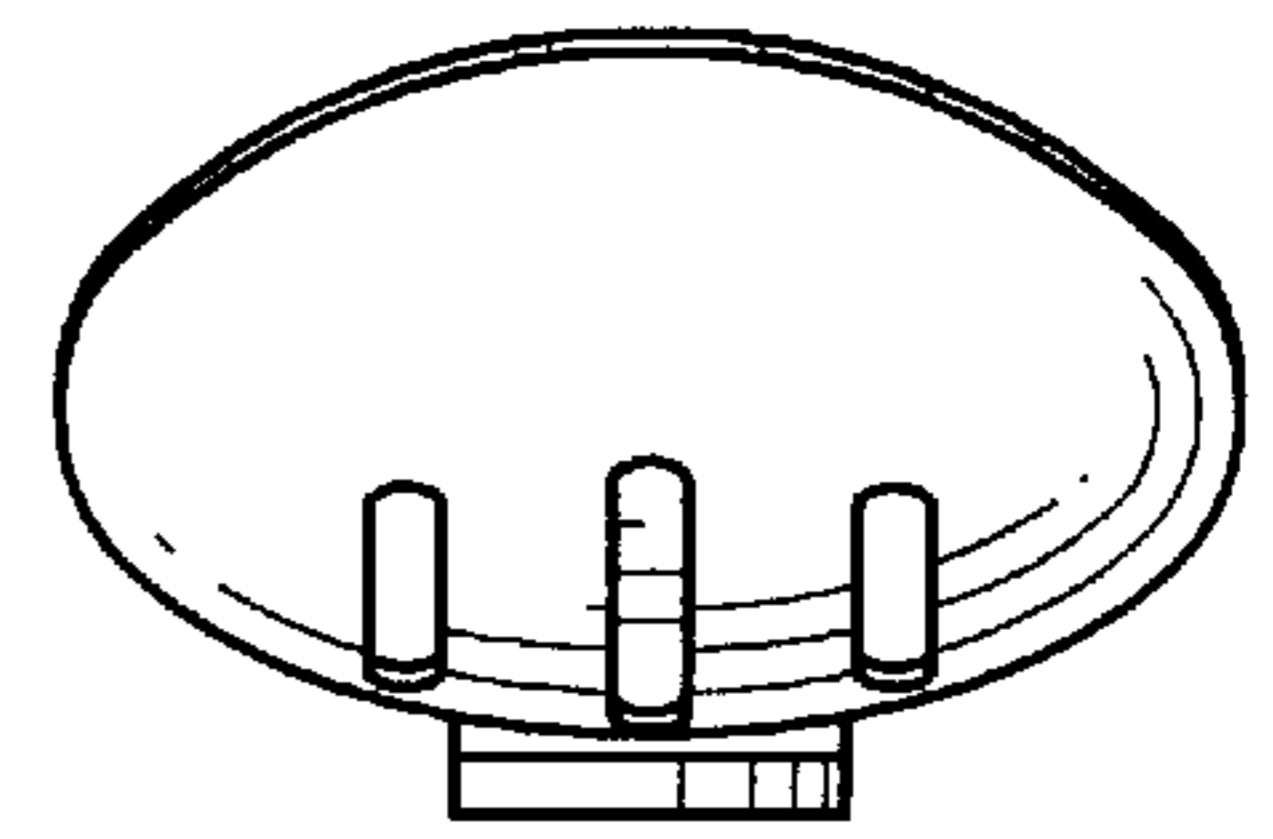

FIG. 10

