

US00D467132S

(12) **United States Design Patent**
Chiu

(10) **Patent No.:** **US D467,132 S**

(45) **Date of Patent:** **** Dec. 17, 2002**

(54) **TOOTH-PICK BOX**

D345,462 S * 3/1994 Davidson D3/271

(76) Inventor: **Ching-Hsing Chiu**, No. 11, Sublane 99,
Lane 103, Section 6, Fu-An Road,
Tainan City (TW)

* cited by examiner

Primary Examiner—Terry A. Wallace
(74) *Attorney, Agent, or Firm*—Rosenberg, Klein & Lee

(**) Term: **14 Years**

(57) **CLAIM**

(21) Appl. No.: **29/150,215**

The ornamental design for a tooth-pick box, as shown and described.

(22) Filed: **Nov. 14, 2001**

(51) **LOC (7) Cl.** **07-99**

(52) **U.S. Cl.** **D7/636**

(58) **Field of Search** D7/635, 636; 206/380–383,
206/457; 221/186–188, 196, 263, 266, 312 A,
154; 222/251; D9/307, 310; D3/271

DESCRIPTION

FIG. 1 is front-right-top perspective view of a tooth-pick box, showing my new design;
FIG. 2 is a front elevation view thereof;
FIG. 3 is a rear elevation view thereof;
FIG. 4 is a left elevation view thereof;
FIG. 5 is a right elevation view thereof;
FIG. 6 is a top plan view thereof; and,
FIG. 7 is a bottom plan view thereof.

(56) **References Cited**

U.S. PATENT DOCUMENTS

D197,348 S * 1/1964 Most D7/636
D201,518 S * 6/1965 Hunt D7/636

1 Claim, 5 Drawing Sheets

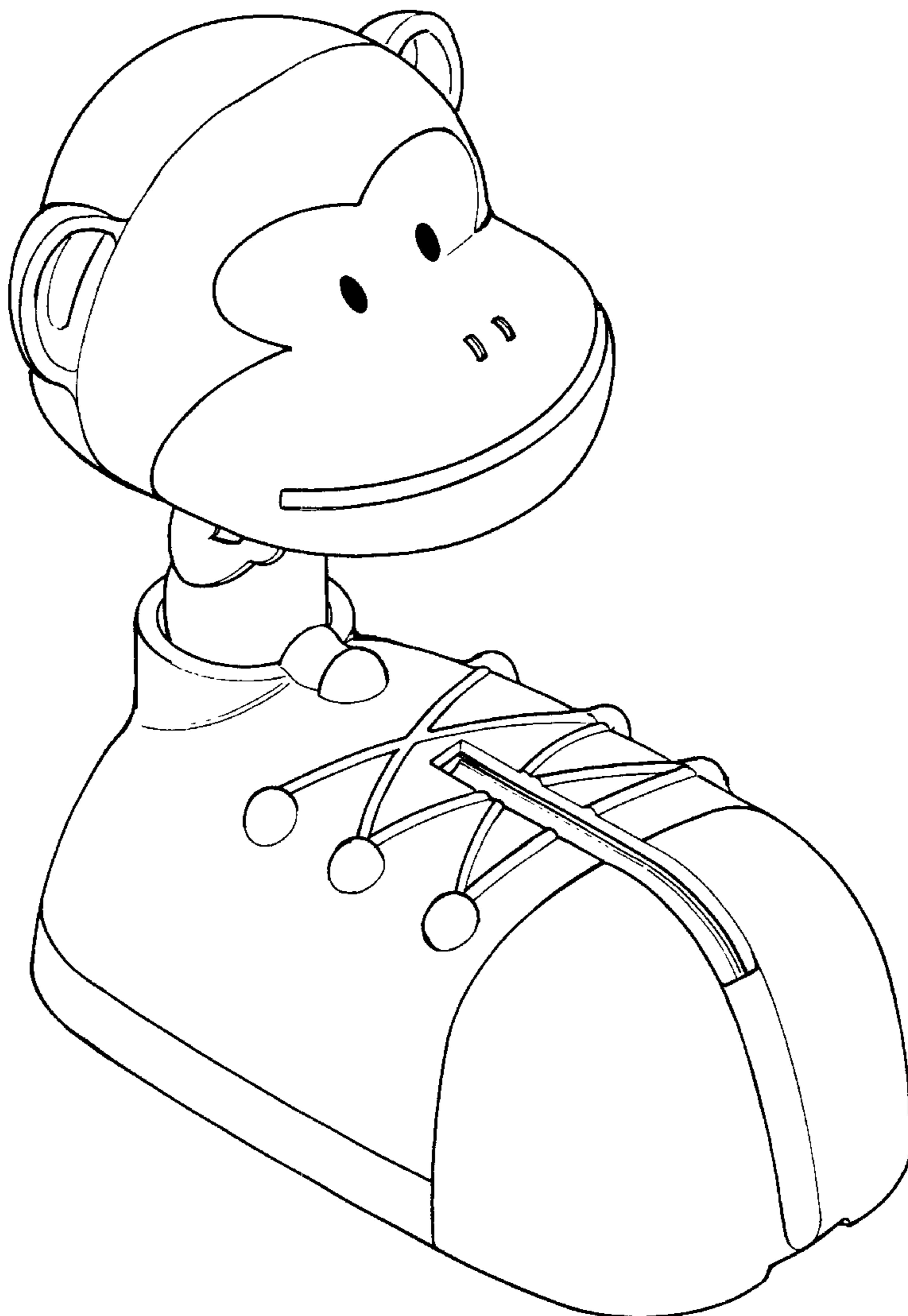

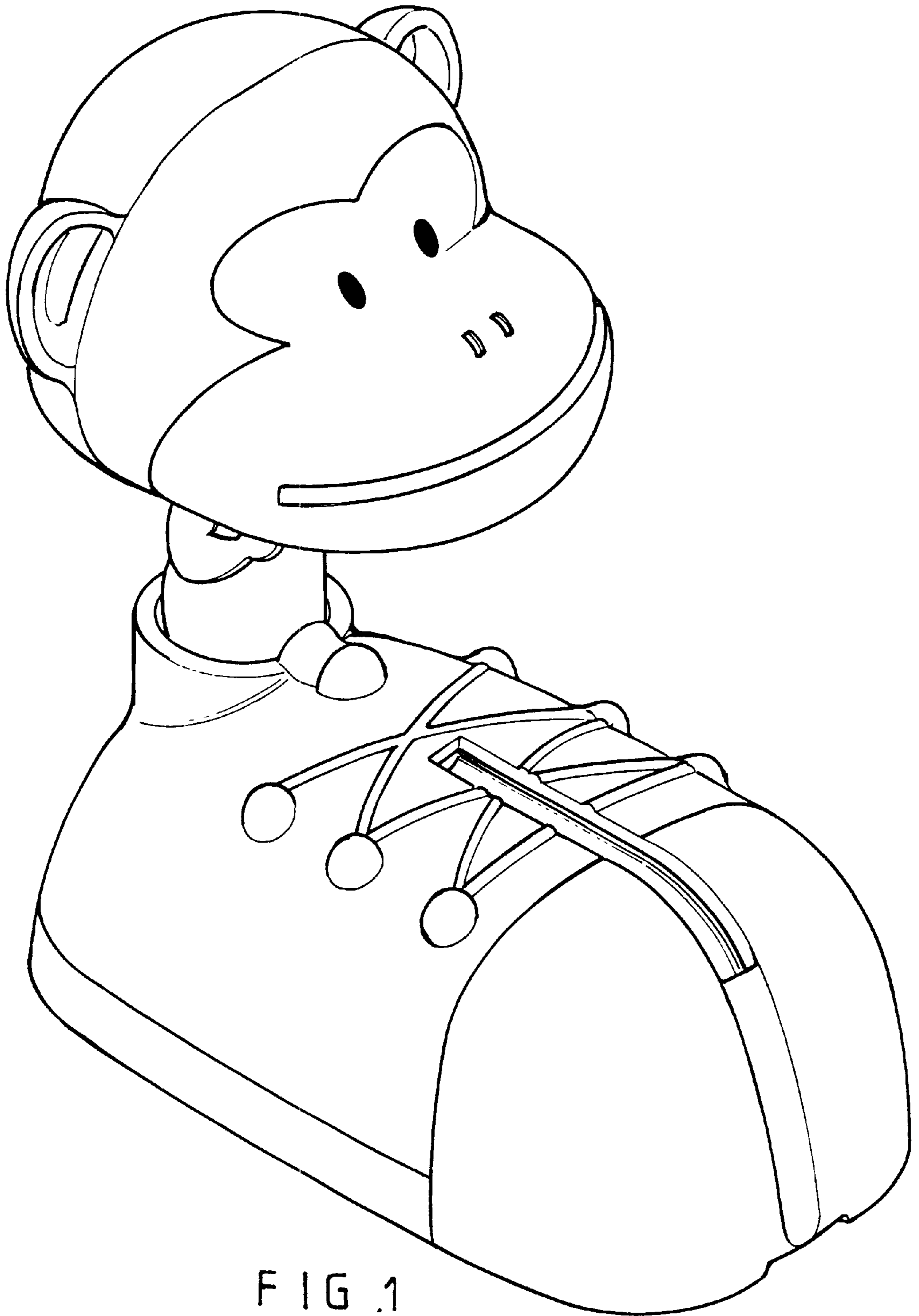

FIG. 1

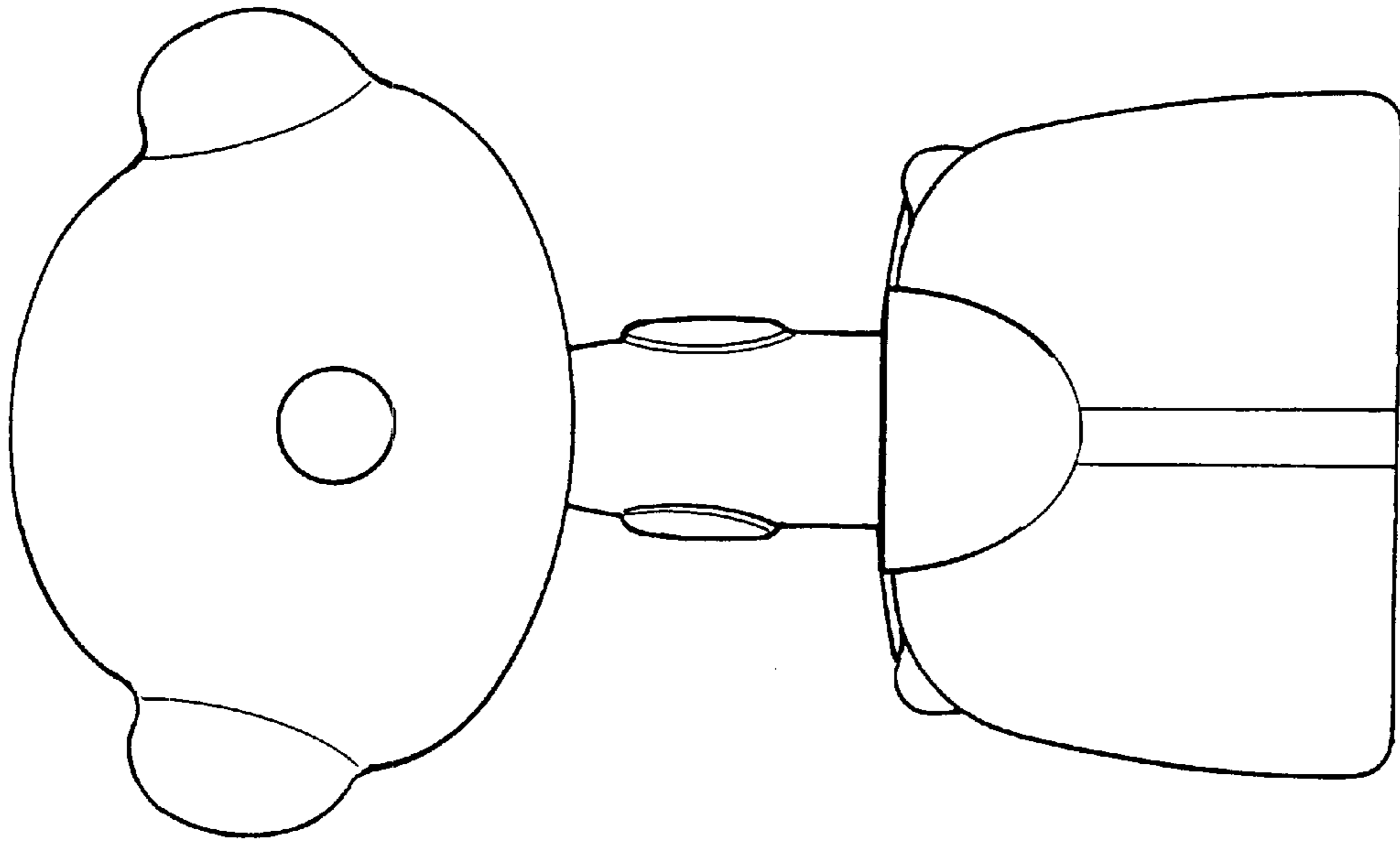

FIG. 3

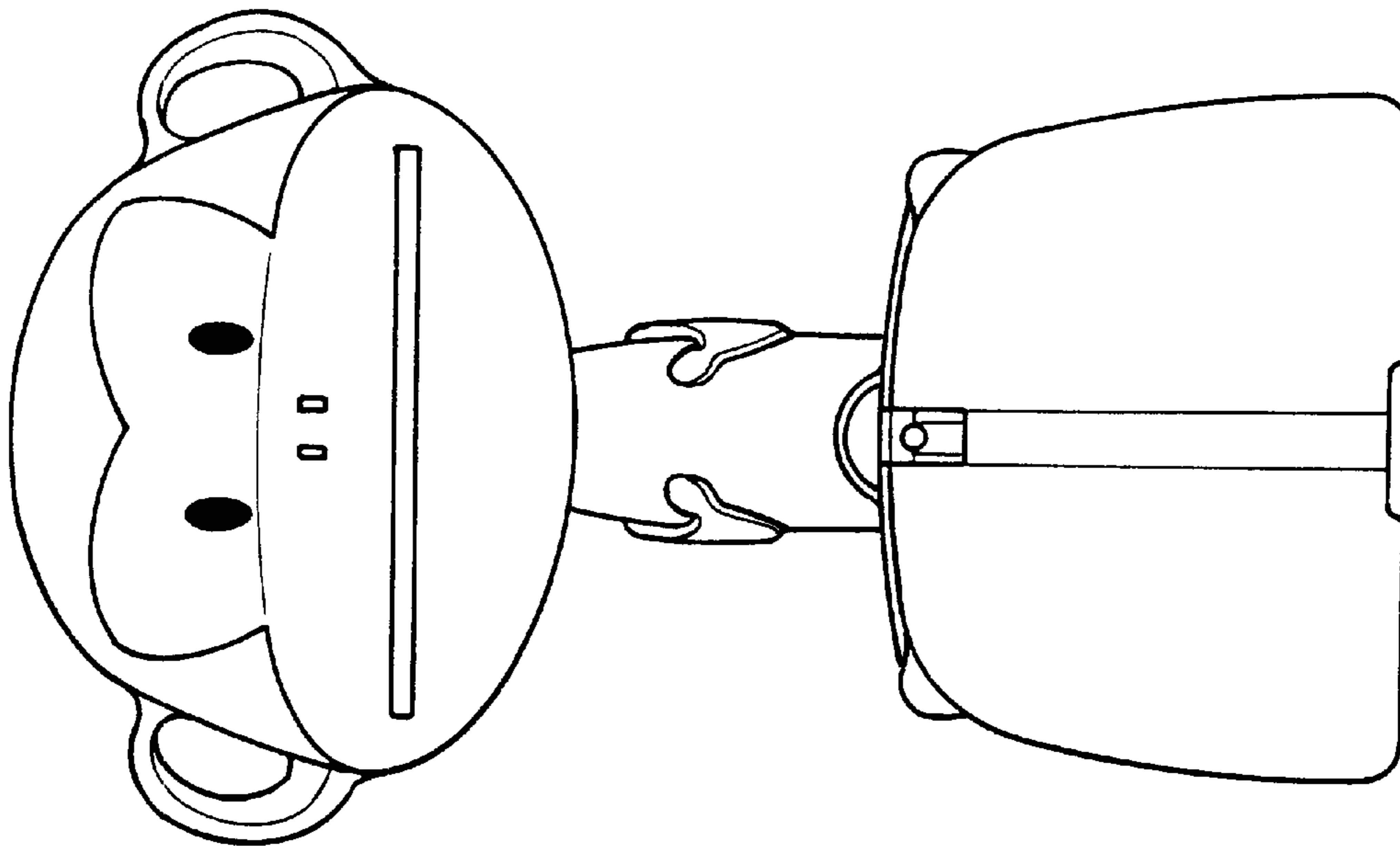

FIG. 2

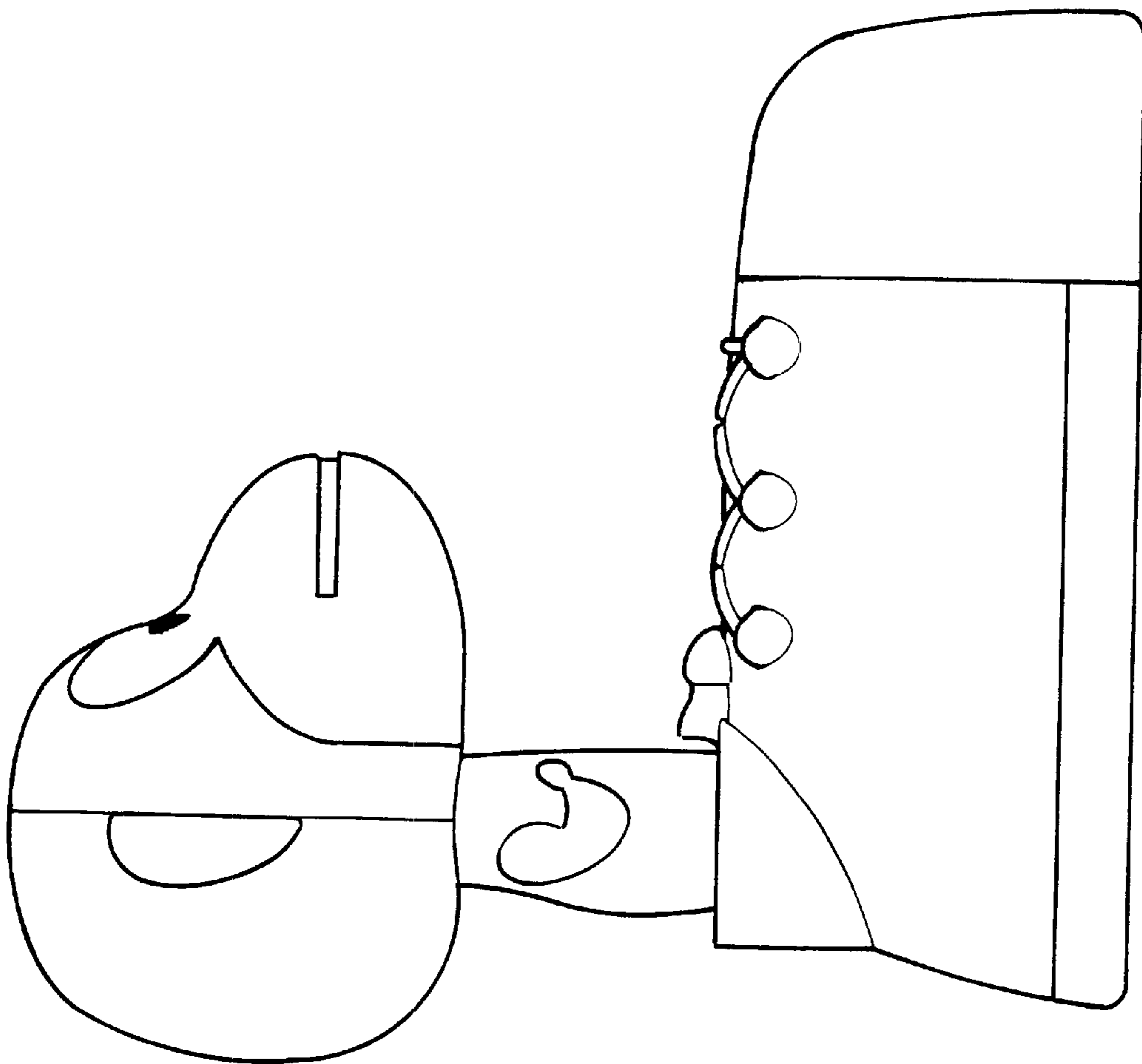

FIG. 4

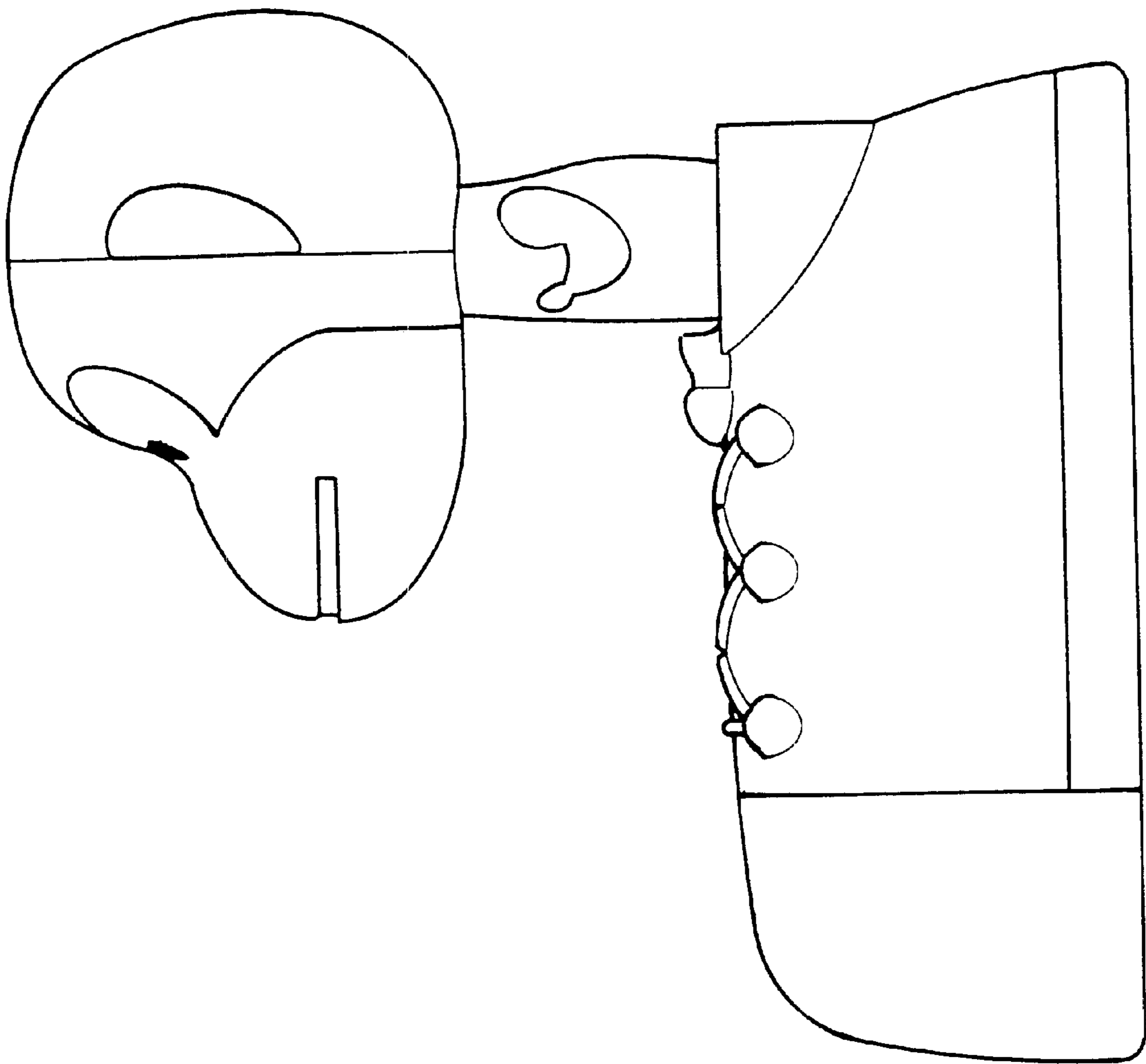

FIG. 5

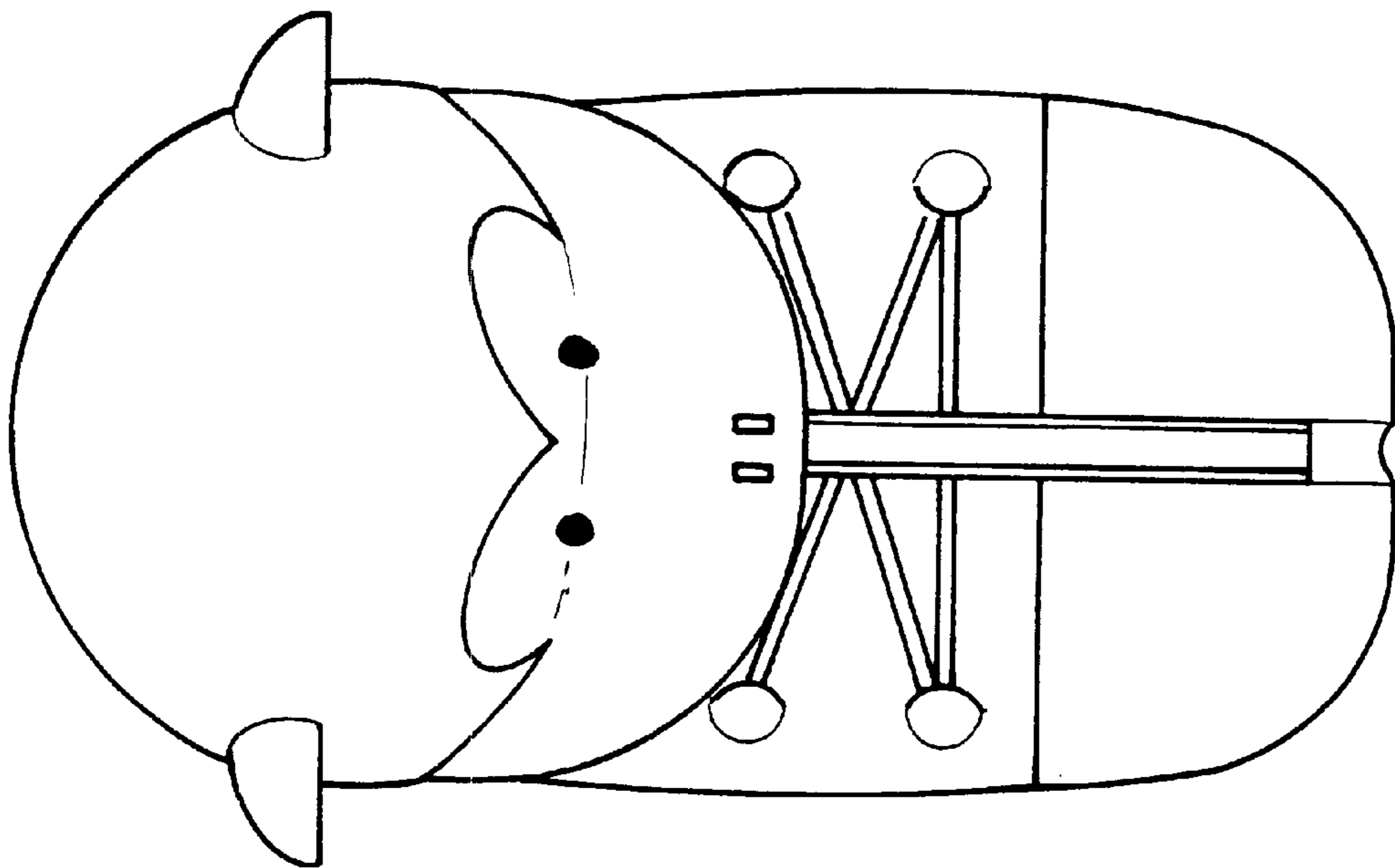

FIG. 6

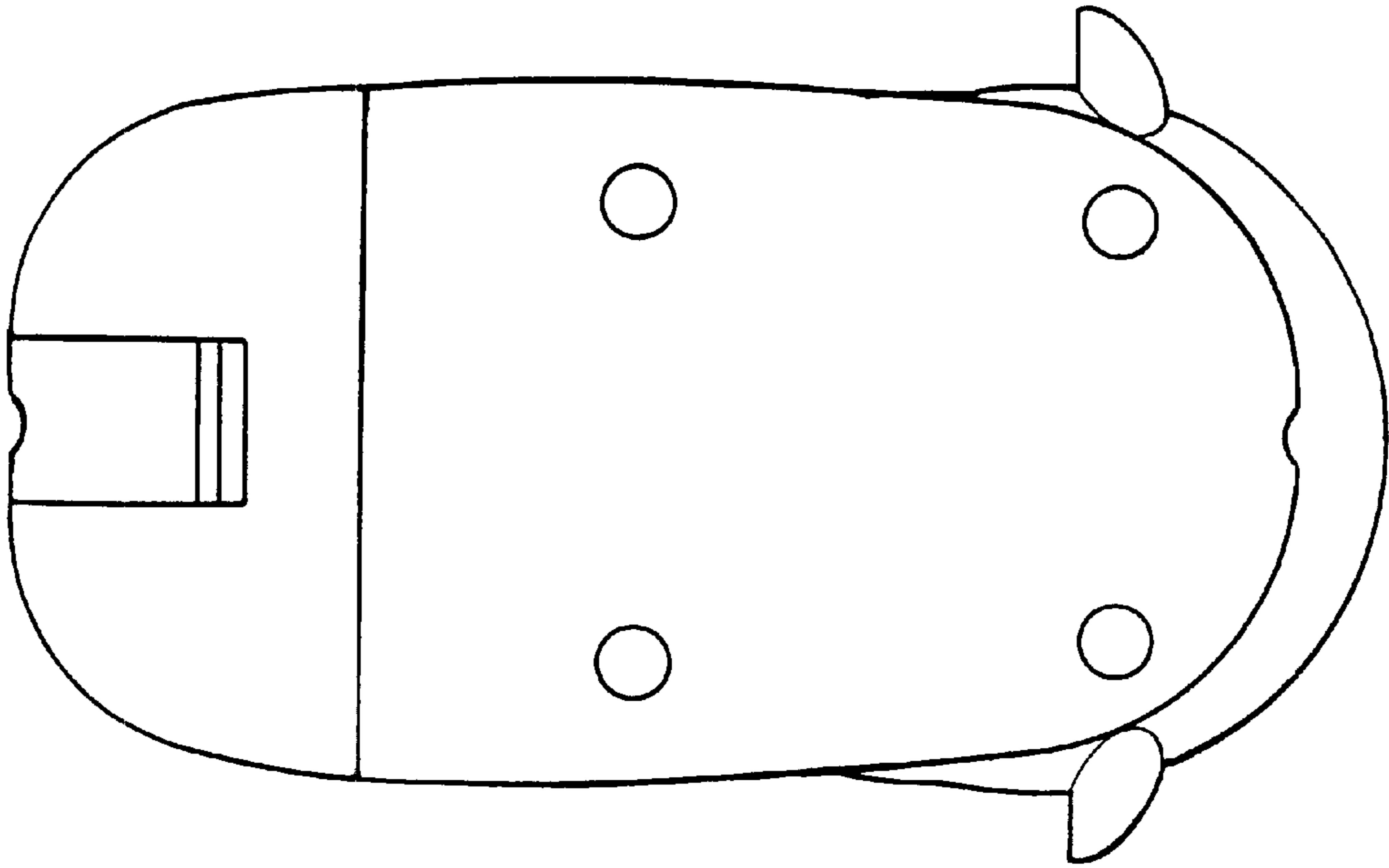

FIG. 7