



US00D466926S

(12) **United States Design Patent**
Miyahara et al.

(10) **Patent No.:** **US D466,926 S**

(45) **Date of Patent:** **** Dec. 10, 2002**

(54) **COMBINED INK TANK HOLDER AND PRINTING HEAD FOR PRINTER**

(75) Inventors: **Kazuhiko Miyahara**, Yokohama (JP); **Yasuo Kotaki**, Yokohami (JP); **Wataru Takahashi**, Kawasaki (JP); **Kenji Kitabatake**, Kawasaki (JP); **Hiroki Hayashi**, Yokohama (JP)

(73) Assignee: **Canon Kabushiki Kaisha**, Tokyo (JP)

(**) Term: **14 Years**

(21) Appl. No.: **29/148,604**

(22) Filed: **Sep. 25, 2001**

(30) **Foreign Application Priority Data**

Apr. 4, 2001 (JP) 2001-009713

(51) **LOC (7) Cl.** **18-02**

(52) **U.S. Cl.** **D18/56; 347/86**

(58) **Field of Search** **D18/56, 43; 347/86, 347/87**

(56) **References Cited**

U.S. PATENT DOCUMENTS

D371,804 S	7/1996	Kotaki et al.	D18/56
5,576,750 A	* 11/1996	Brandon et al.	347/87
5,627,577 A	* 5/1997	Buican	D18/56
5,638,099 A	* 6/1997	Nguyen et al.	D18/56

D382,013 S	8/1997	Tashiro et al.	D18/56
D395,916 S	* 7/1998	Inoue et al.	D18/56
5,831,653 A	* 11/1998	Brandon et al.	347/87
D425,556 S	* 5/2000	Inoue et al.	D18/56
D425,933 S	5/2000	Inoue et al.	D18/56
D430,201 S	8/2000	Inoue et al.	D18/56
D438,243 S	2/2001	Chiba et al.	D18/56
D438,561 S	3/2001	Chiba et al.	D18/56
D438,898 S	* 3/2001	Chiba et al.	D18/56
D447,514 S	* 9/2001	Takanaka et al.	D18/56

* cited by examiner

Primary Examiner—Cathy Anne MacCormac

(74) *Attorney, Agent, or Firm*—Fitzpatrick, Cella, Harper & Scinto

(57) **CLAIM**

The ornamental design for a combined ink tank holder and printing head for printer, as shown and described.

DESCRIPTION

FIG. 1 is a front view of an combined ink tank holder and printing head for printer showing our new design; FIG. 2 is a rear view thereof; FIG. 3 is a top plan view thereof; FIG. 4 is a bottom plan view thereof; FIG. 5 is a left side view thereof; FIG. 6 is a right side view thereof; and, FIG. 7 is a perspective view thereof.

1 Claim, 4 Drawing Sheets

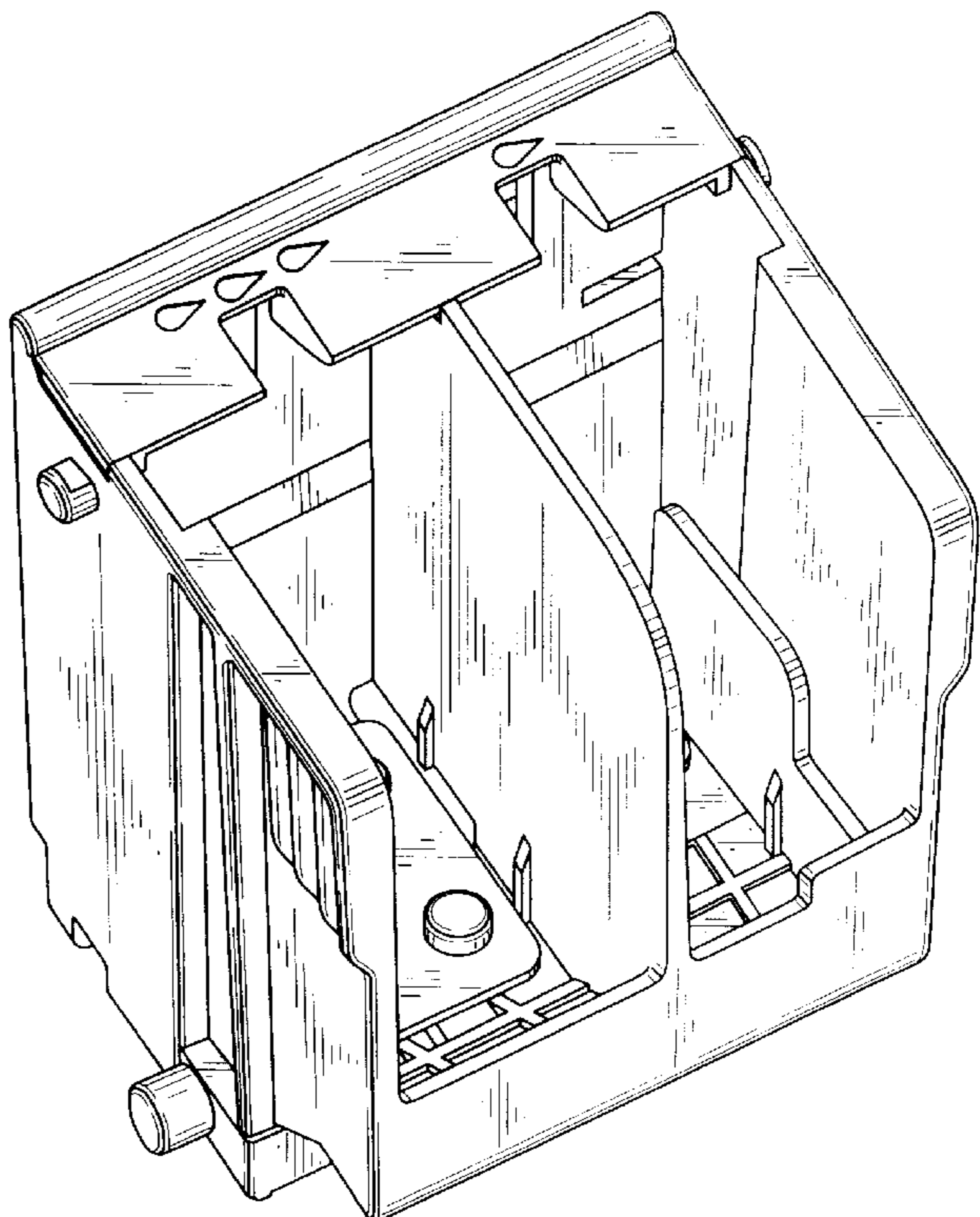
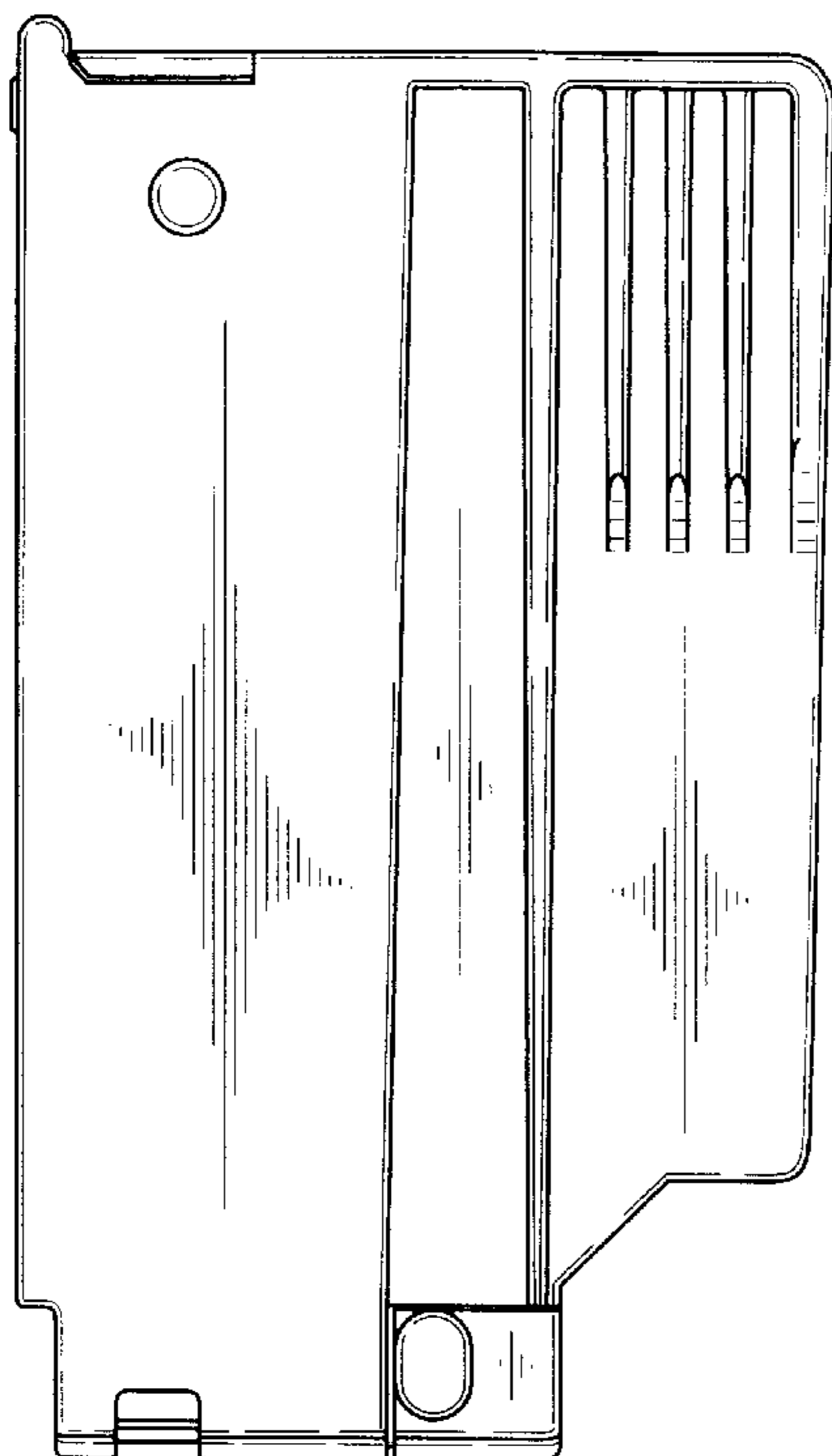

FIG. 1

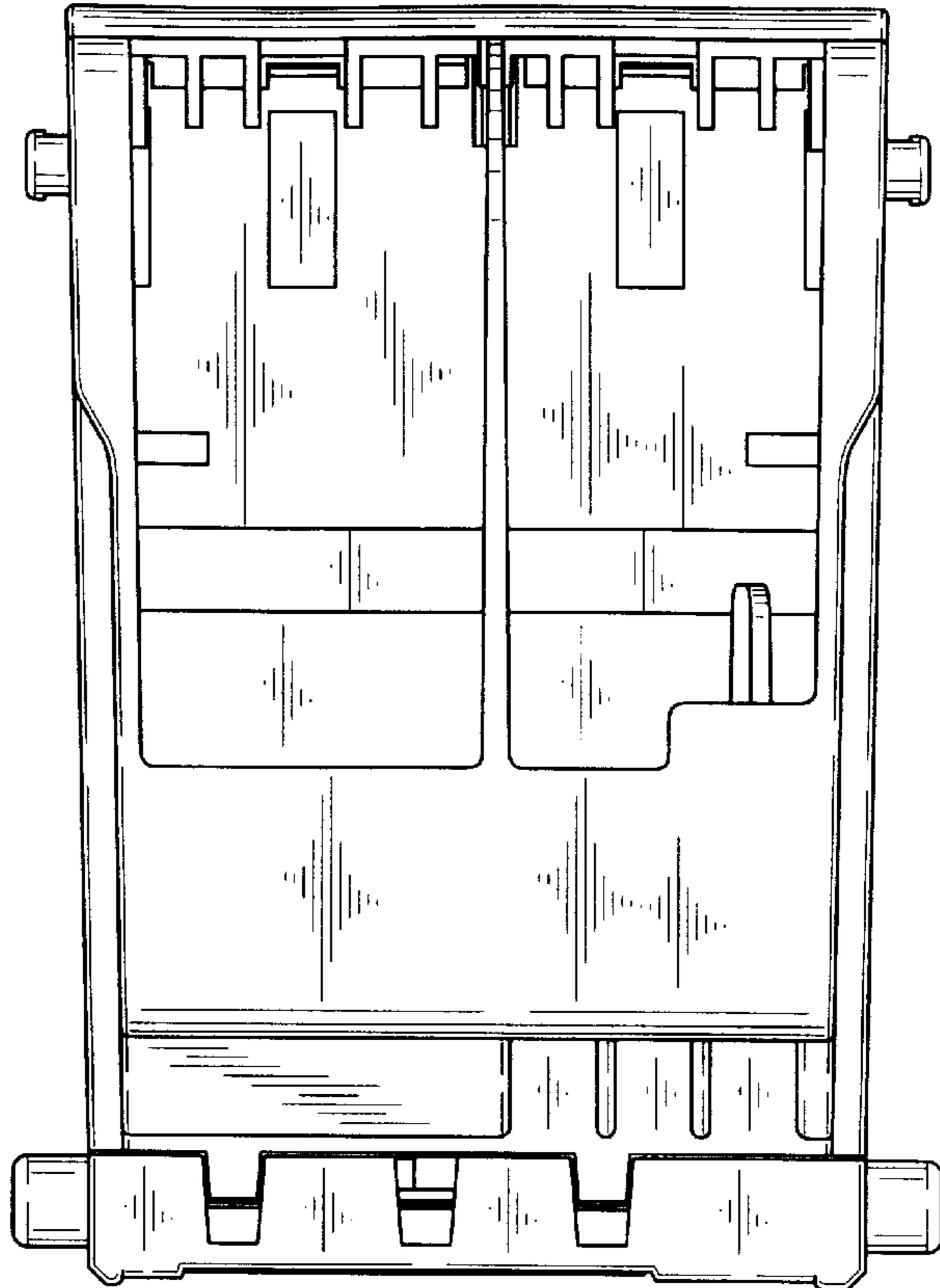

FIG. 2

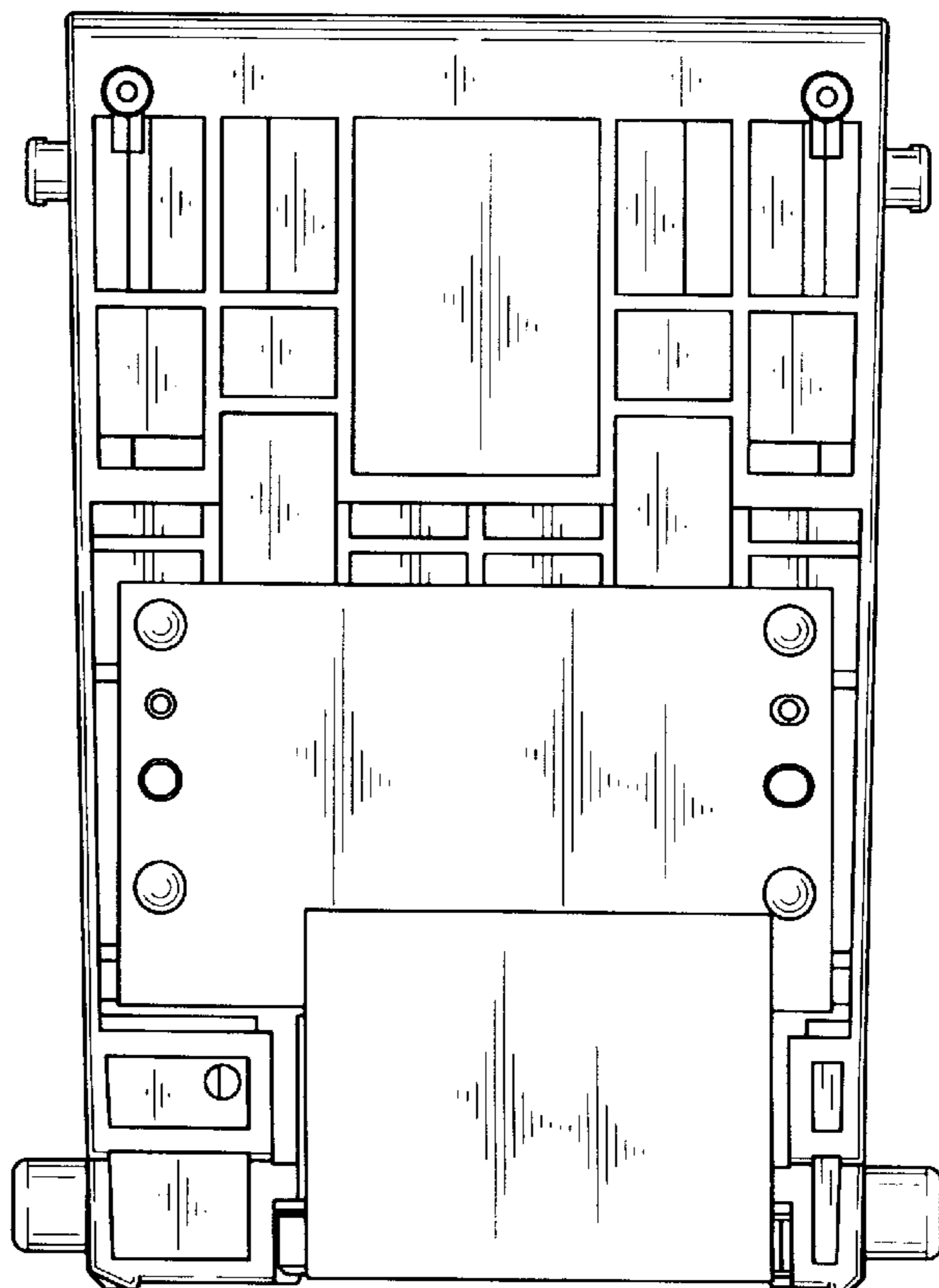

FIG. 3

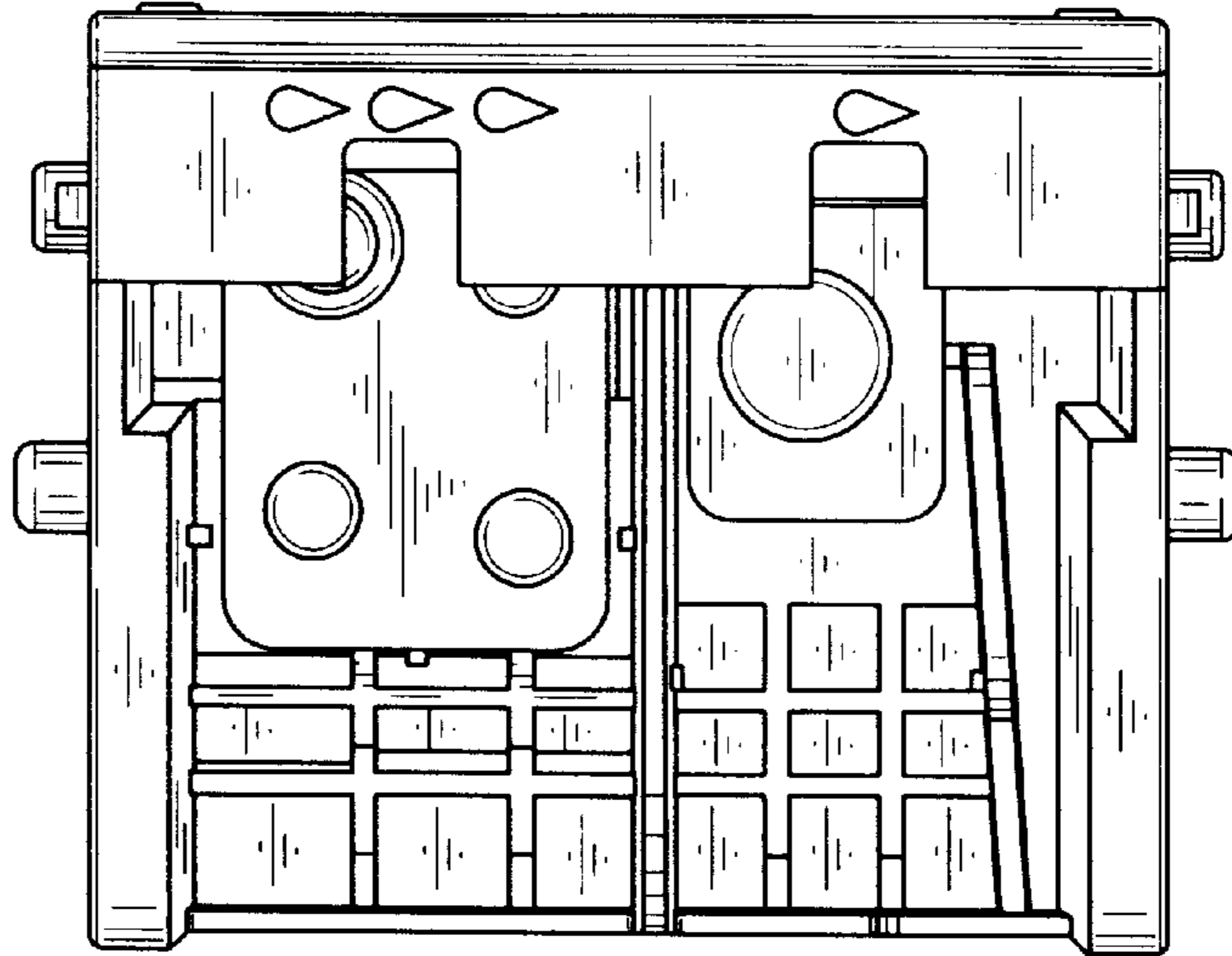

FIG. 4

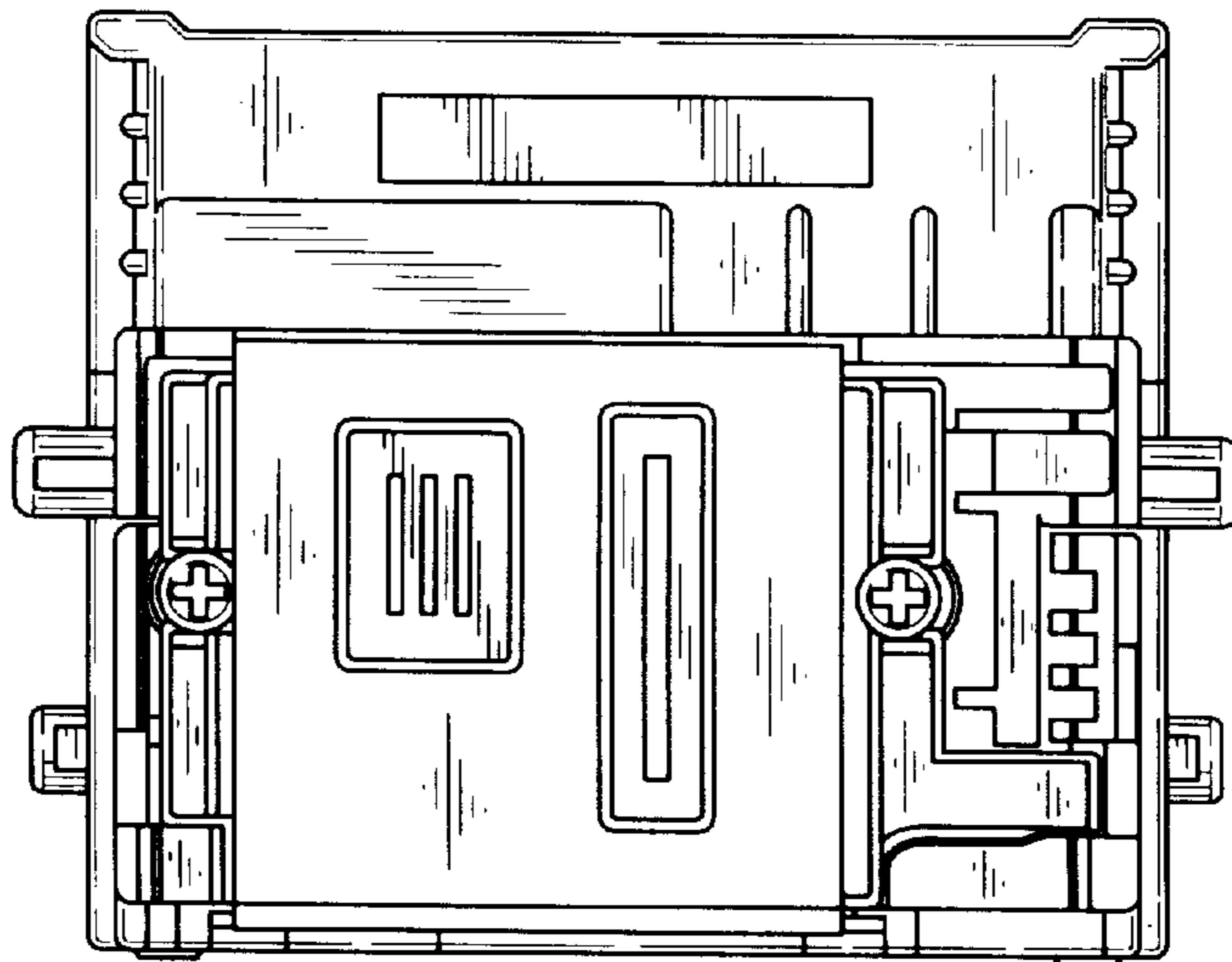

FIG. 5

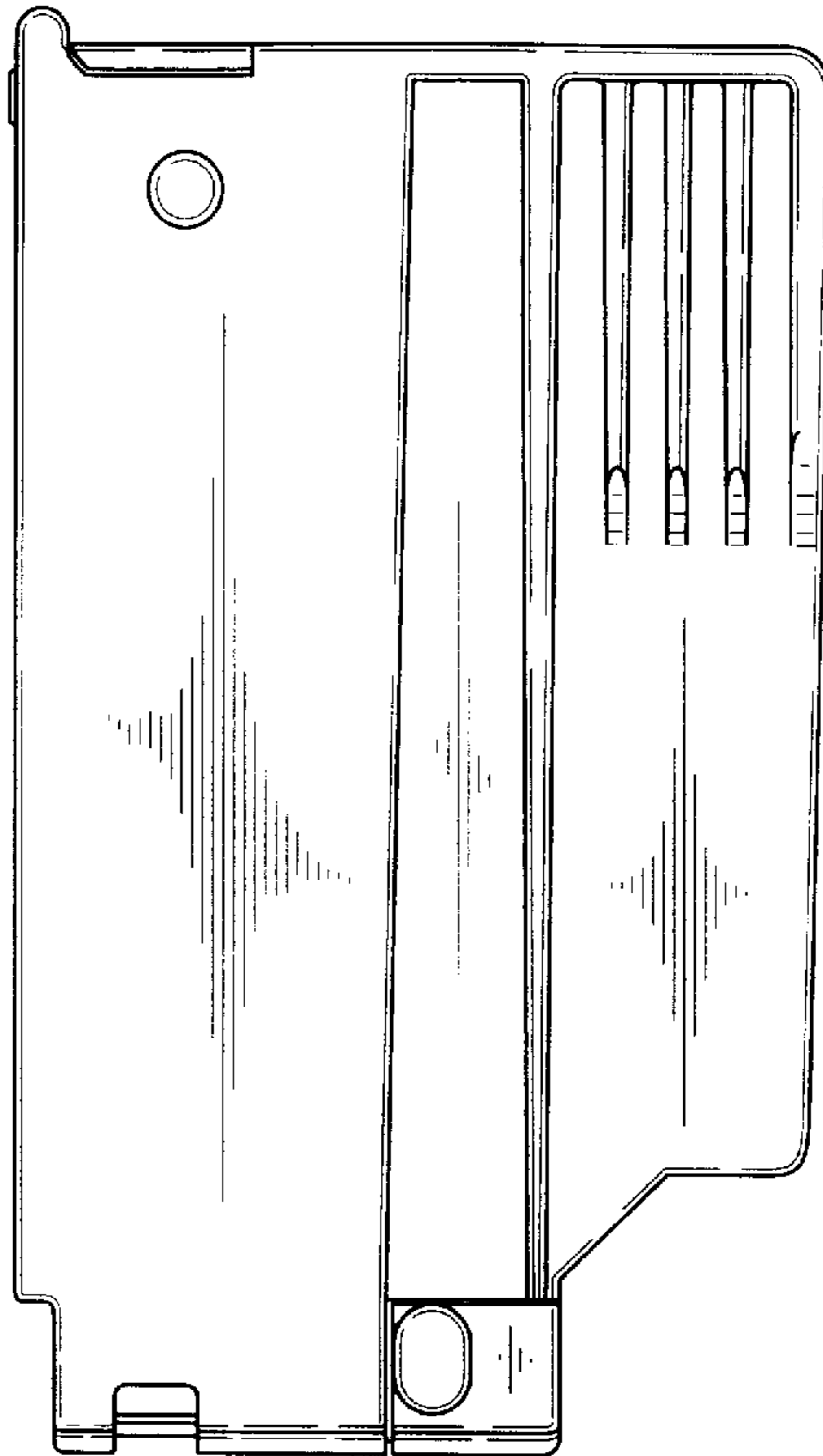

FIG. 6

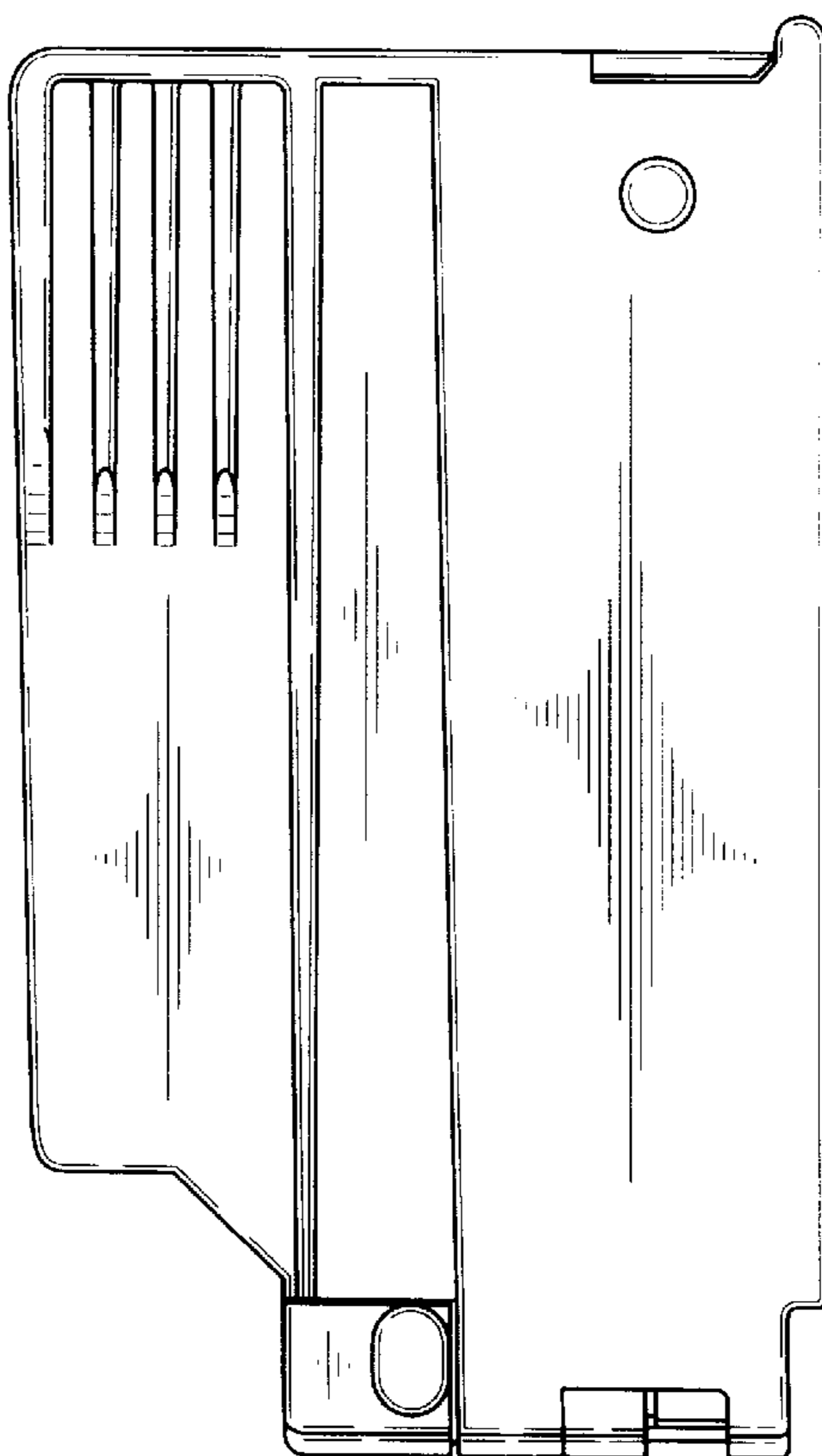

FIG. 7

