



US00D466879S

(12) **United States Design Patent**
Wada et al.

(10) **Patent No.:** **US D466,879 S**

(45) **Date of Patent:** **** Dec. 10, 2002**

(54) **MOBILE PHONE**

(75) Inventors: **Takeshi Wada**, Chiba (JP); **Hiromi Chida**, Chiba (JP)

(73) Assignee: **Seiko Instruments Inc.**, Chiba (JP)

(**) Term: **14 Years**

(21) Appl. No.: **29/158,965**

(22) Filed: **Apr. 15, 2002**

Related U.S. Application Data

(62) Division of application No. 29/140,124, filed on Apr. 13, 2001.

(30) **Foreign Application Priority Data**

Dec. 28, 2000	(JP)	2000-37591
Dec. 28, 2000	(JP)	2000-37592
Dec. 28, 2000	(JP)	2000-37593
Dec. 28, 2000	(JP)	2000-37594

(51) **LOC (7) Cl.** **14-03**

(52) **U.S. Cl.** **D14/138; D10/31**

(58) **Field of Search** D14/137, 138,
D14/218, 147-148, 247-248, 144, 191,
341-347, 205, 206, 223; 379/433.01-433.13,
419, 434, 428.01-428.04, 420.01-420.04,
440; 455/550-575, 90; D10/30-32, 38-39;
368/10, 13

(56) **References Cited**

U.S. PATENT DOCUMENTS

D299,463	S	*	1/1989	Hermann	D14/344
4,847,818	A	*	7/1989	Olsen	368/10
5,218,577	A	*	6/1993	Seager	368/10
5,224,076	A	*	6/1993	Thorp	368/10
5,228,012	A	*	7/1993	Seager	368/10

5,235,560	A	*	8/1993	Seager	368/10
5,235,561	A	*	8/1993	Seager	368/10
5,251,189	A	*	10/1993	Thorp	368/4
5,260,915	A	*	11/1993	Houlihan	368/10
D342,740	S	*	12/1993	Parker	D14/218
5,274,613	A	*	12/1993	Seager	368/13
D350,351	S	*	9/1994	Nakamura	D14/156
5,381,387	A	*	1/1995	Blonder	368/10
D360,590	S	*	7/1995	Murakami et al.	D10/31
5,467,324	A	*	11/1995	Houlihan	368/10
D366,036	S	*	1/1996	Houlihan	D14/344
D381,653	S	*	7/1997	Voroba et al.	D14/138
5,819,183	A	*	10/1998	Voroba et al.	455/550
D402,654	S	*	12/1998	Consolo	D14/144
5,872,744	A	*	2/1999	Taylor	368/13
6,035,035	A	*	3/2000	Firooz	379/433.1
D434,675	S	*	12/2000	Ando et al.	D10/31

* cited by examiner

Primary Examiner—Jeffrey Asch

(74) *Attorney, Agent, or Firm*—Finnegan, Henderson, Farabow, Garrett & Dunner LLP

(57) **CLAIM**

The ornamental design for a mobile phone, as shown and described.

DESCRIPTION

FIG. 1 is a perspective view of the top, front and left side of our new design;
FIG. 2 is a top plan view thereof;
FIG. 3 is a front view thereof;
FIG. 4 is a rear view thereof;
FIG. 5 is a bottom view thereof;
FIG. 6 is a left side view thereof;
FIG. 7 is a right side view thereof; and,
FIG. 8 is a perspective view of the top, front and left side thereof with the band portion connected in the circle.

1 Claim, 4 Drawing Sheets

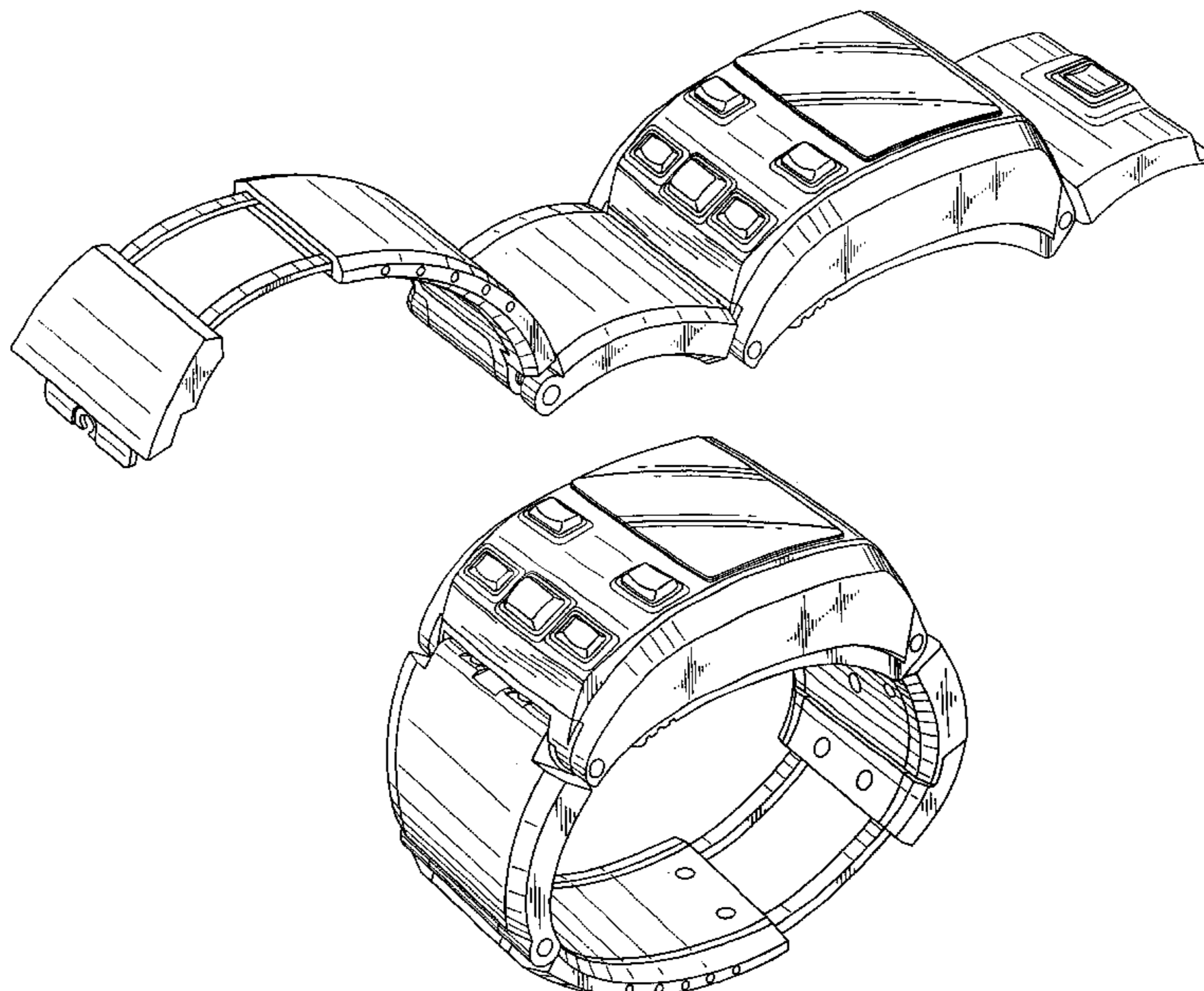

FIG. 1

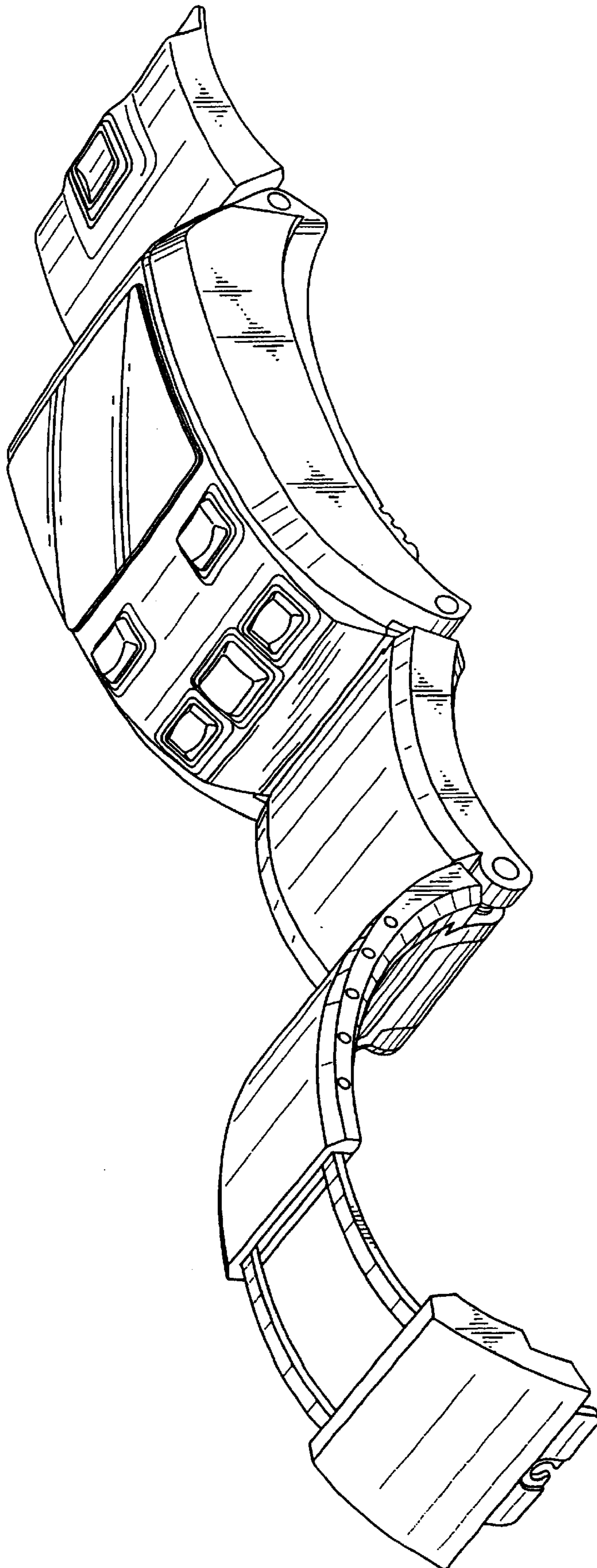

FIG. 2

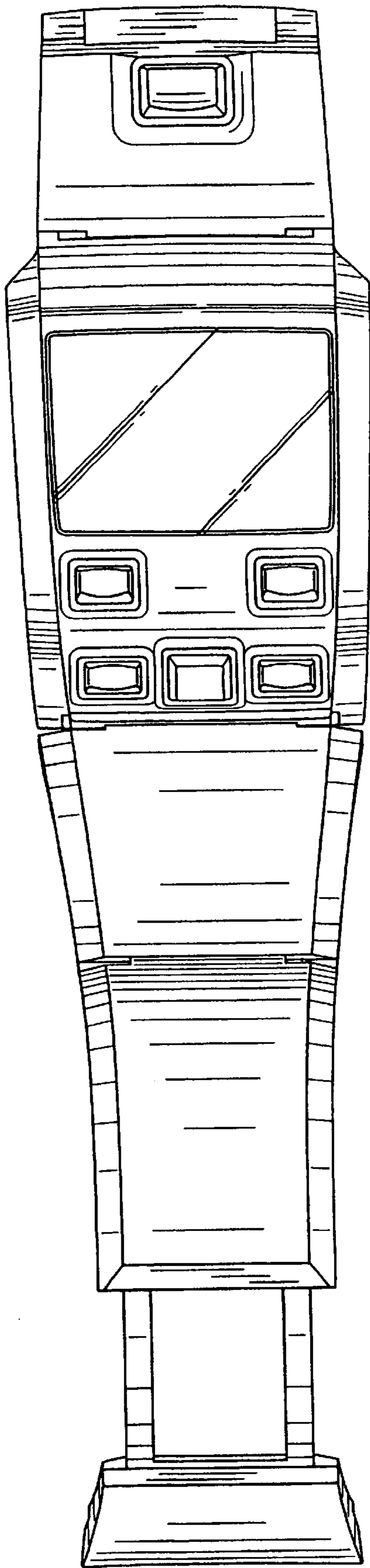

FIG. 3

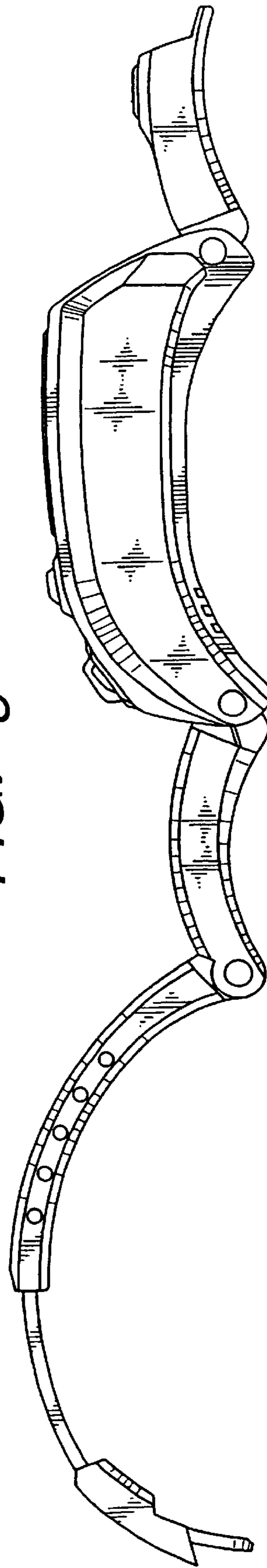

FIG. 4

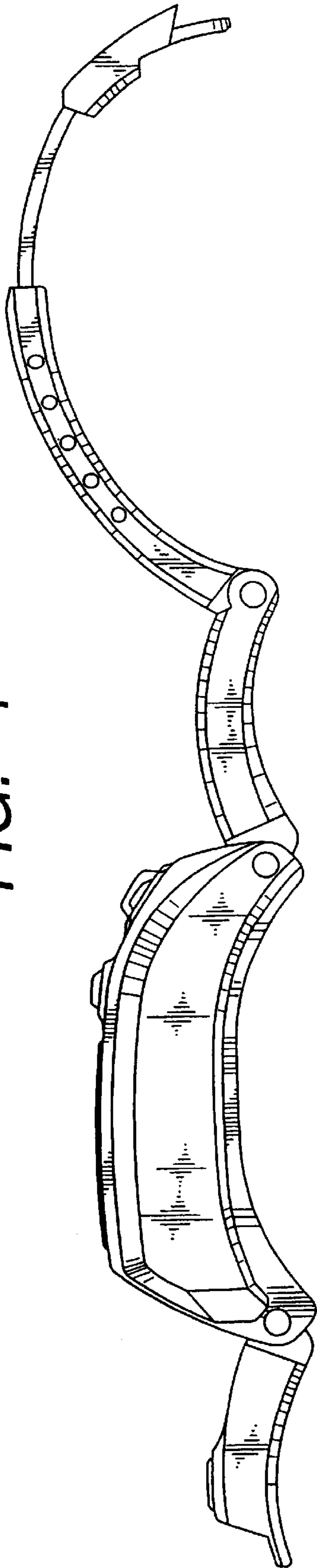

FIG. 5

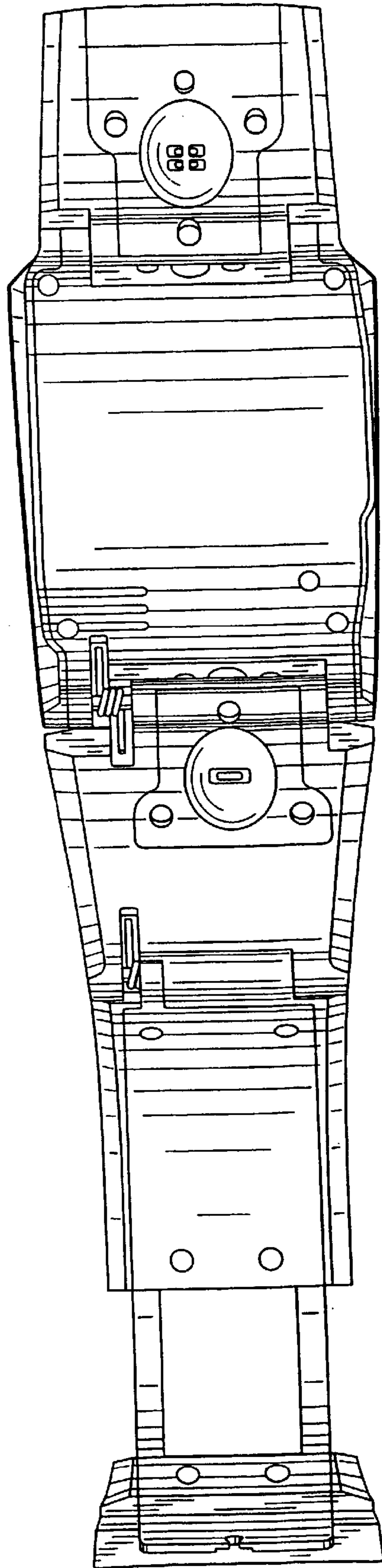

FIG. 6

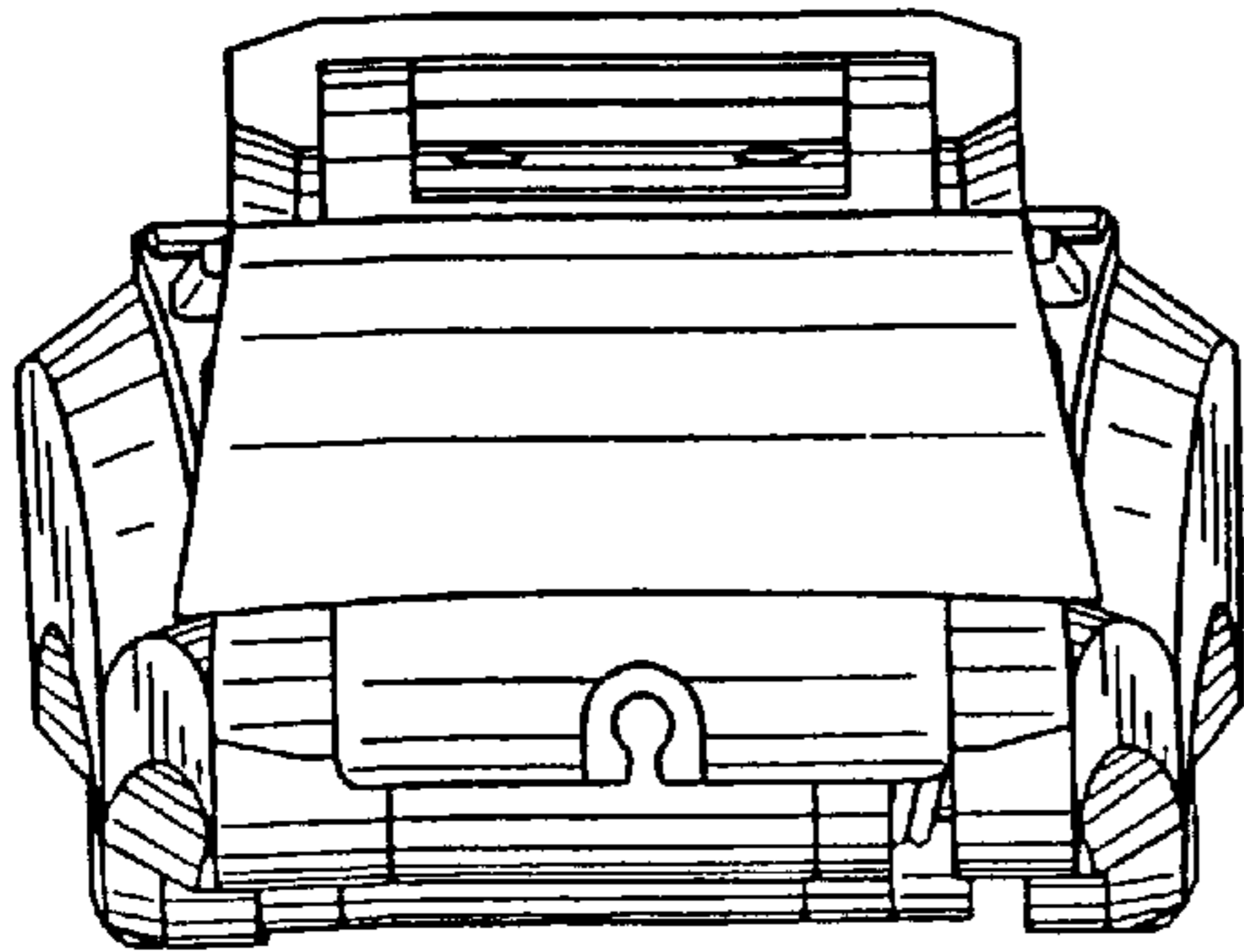

FIG. 7

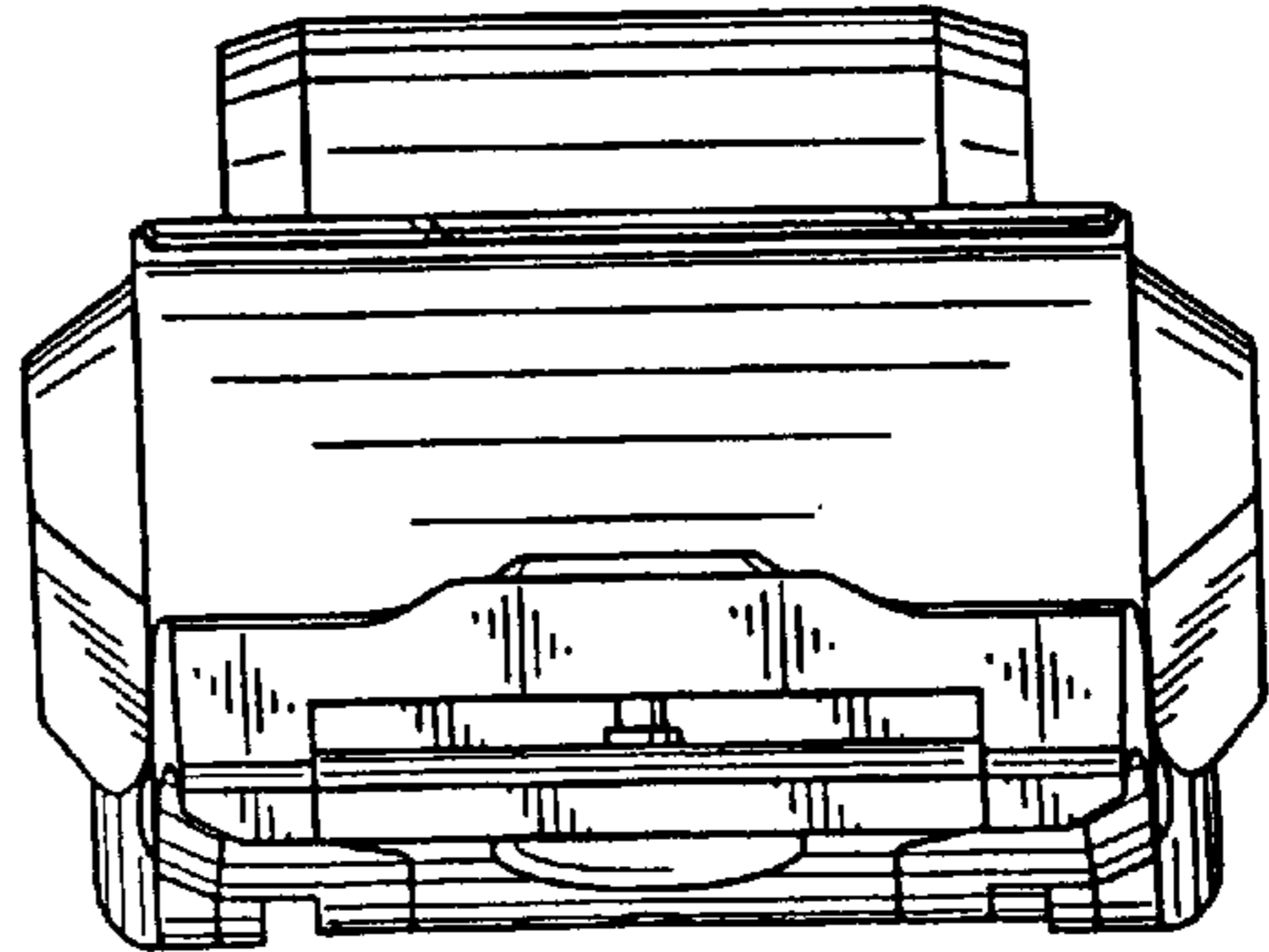

FIG. 8

