



US00D466826S

(12) **United States Design Patent**  
**Takata et al.**

(10) **Patent No.:** **US D466,826 S**

(45) **Date of Patent:** **\*\* Dec. 10, 2002**

(54) **APPARATUS FOR INPUTTING,  
OUTPUTTING AND/OR DISPLAYING DATA  
OF COMPETITIVE SPORTS**

(75) Inventors: **Atsushi Takata**, Hiroshima (JP);  
**Akihiro Koumoto**, Hiroshima (JP)

(73) Assignee: **Molten Corporation**, Hiroshima (JP)

(\*\*) Term: **14 Years**

(21) Appl. No.: **29/136,317**

(22) Filed: **Jan. 30, 2001**

(30) **Foreign Application Priority Data**

Aug. 4, 2000 (JP) ..... 2000-021620

(51) **LOC (7) Cl.** ..... **10-02**

(52) **U.S. Cl.** ..... **D10/125**

(58) **Field of Search** ..... D10/1-40, 122-132;  
D16/222; 368/96-100, 107-121, 276-277,  
285, 316, 317, 10; 340/323 R

(56) **References Cited**

**U.S. PATENT DOCUMENTS**

- 3,638,215 A \* 1/1972 Payne ..... 345/156
- 4,045,788 A \* 8/1977 Castelli et al. .... 340/323 R
- D250,999 S \* 2/1979 Karibe et al. .... D10/125
- 4,270,196 A \* 5/1981 Terzian ..... 368/82
- 4,483,628 A \* 11/1984 Terzian ..... 368/82

- 4,627,737 A \* 12/1986 Nance et al. .... 368/239
- 4,671,673 A \* 6/1987 Terzian ..... 368/82
- 5,812,049 A \* 9/1998 Uzi ..... 340/323 R
- 6,052,054 A \* 4/2000 Hampson et al. .... 340/568.1
- 6,270,431 B1 \* 8/2001 Martin ..... 473/459

\* cited by examiner

*Primary Examiner*—Nelson C. Holtje

(74) *Attorney, Agent, or Firm*—Armstrong, Westerman & Hattori, LLP

(57) **CLAIM**

The ornamental design for apparatus for inputting, outputting and/or displaying data of competitive sports, as shown and described.

**DESCRIPTION**

FIG. 1 is a front view of our new design of apparatus for inputting, outputting and/or displaying data of competitive sports;  
 FIG. 2 is a rear view thereof;  
 FIG. 3 is a plane view thereof;  
 FIG. 4 is a bottom view thereof;  
 FIG. 5 is a right side view thereof;  
 FIG. 6 is a left side view thereof;  
 FIG. 7 is a perspective view showing how to use of the instant article; and,  
 FIG. 8 is a perspective view at the rear side of the instant article.

**1 Claim, 8 Drawing Sheets**

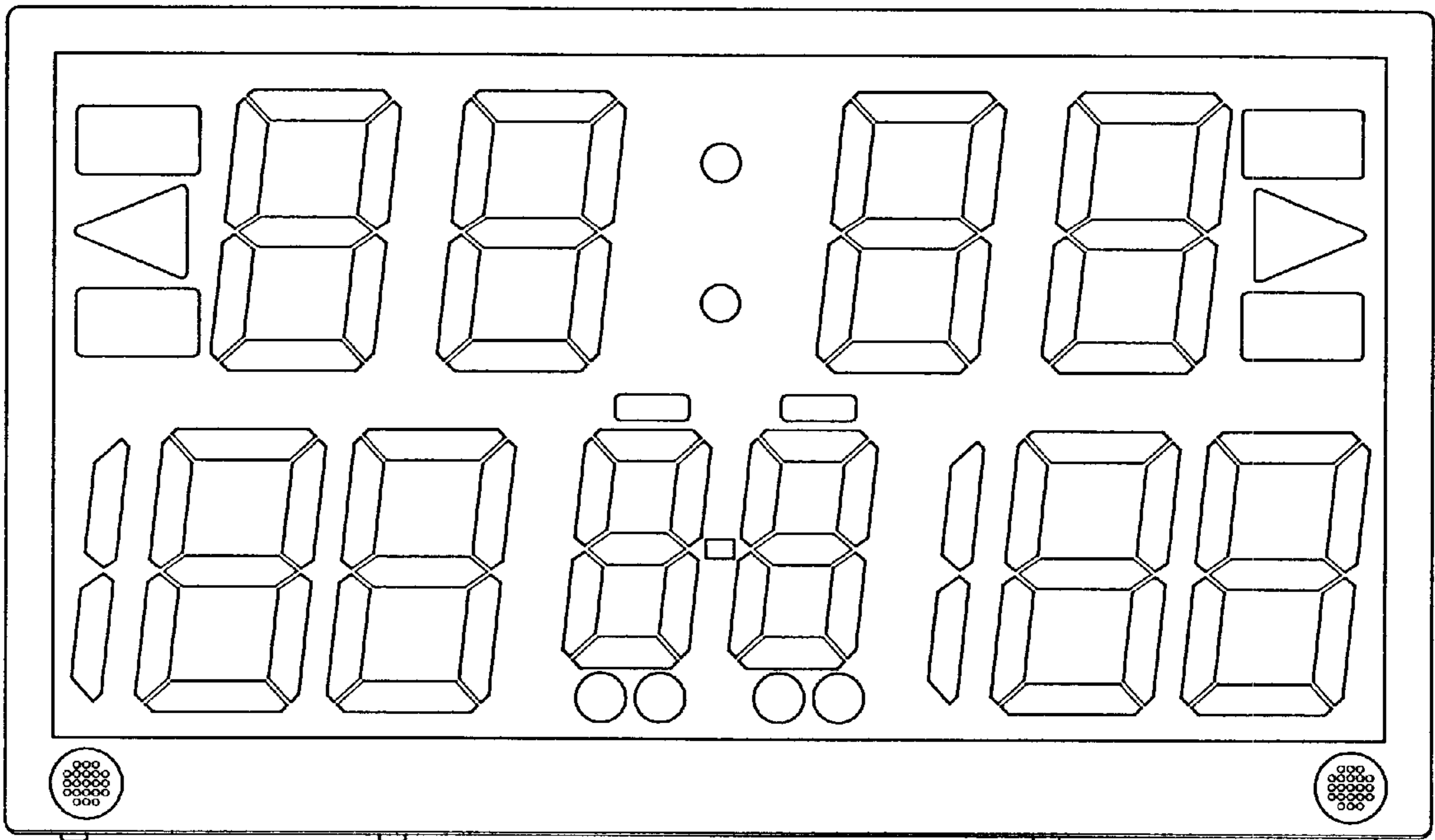

FIG. 1

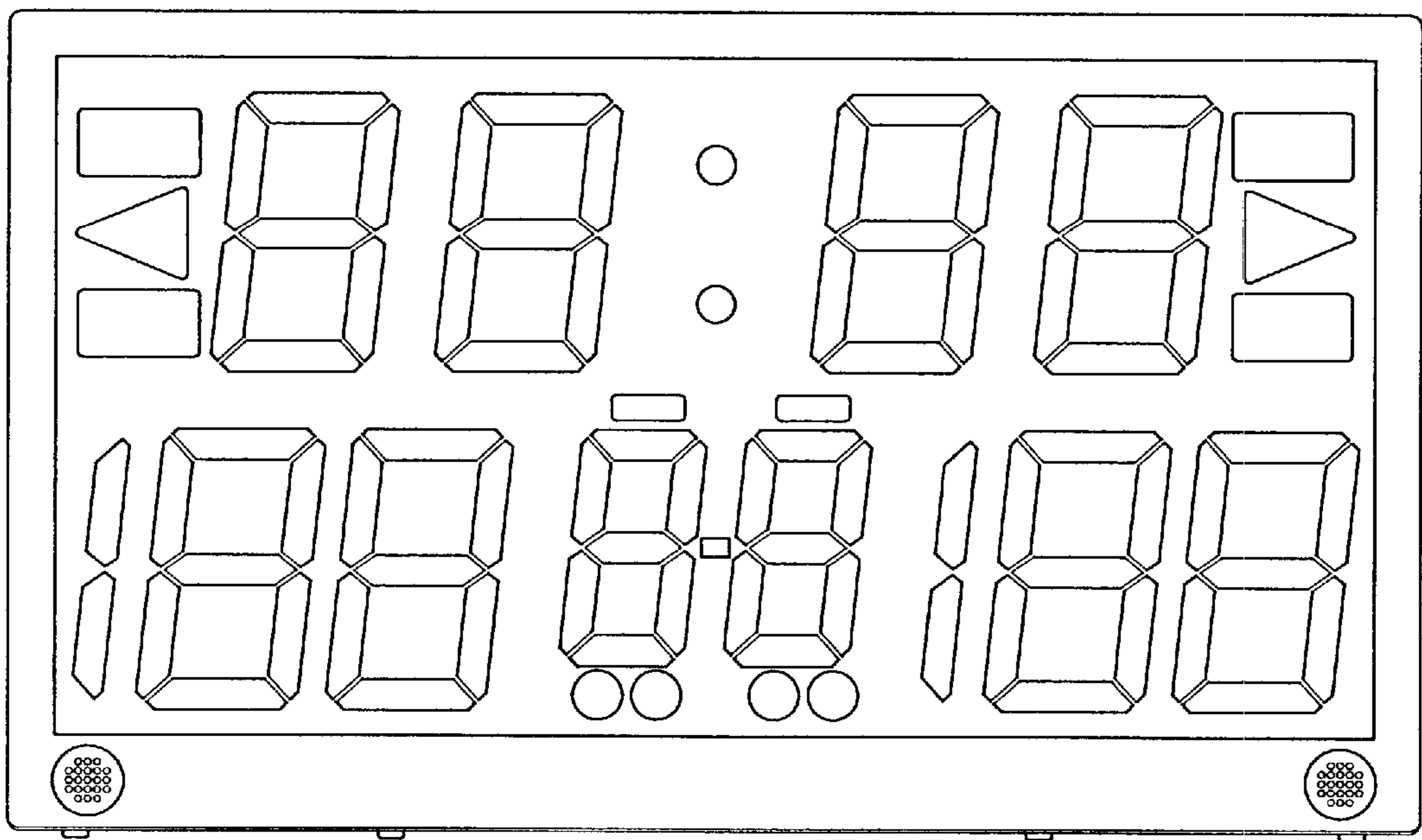

FIG. 2

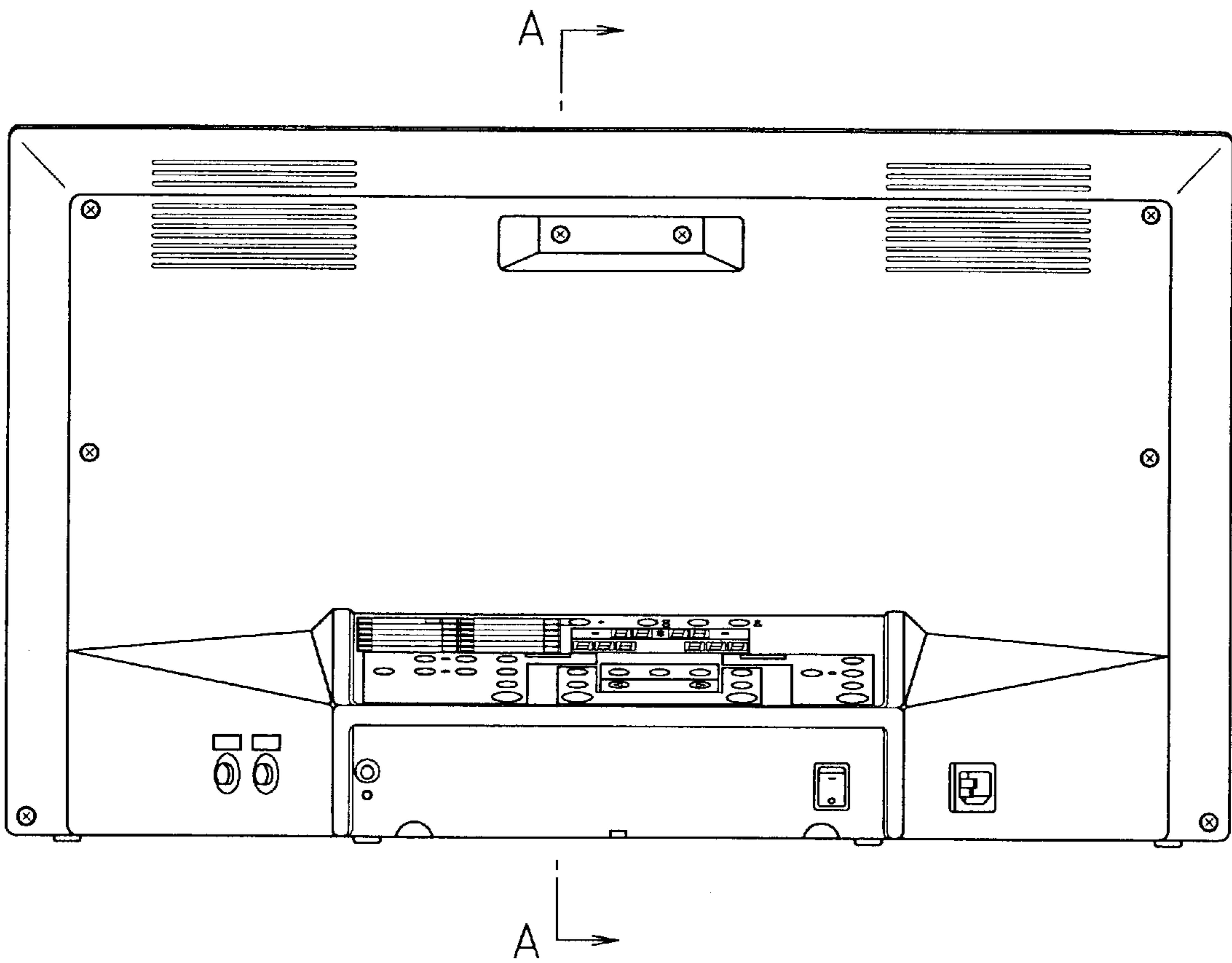

FIG. 3

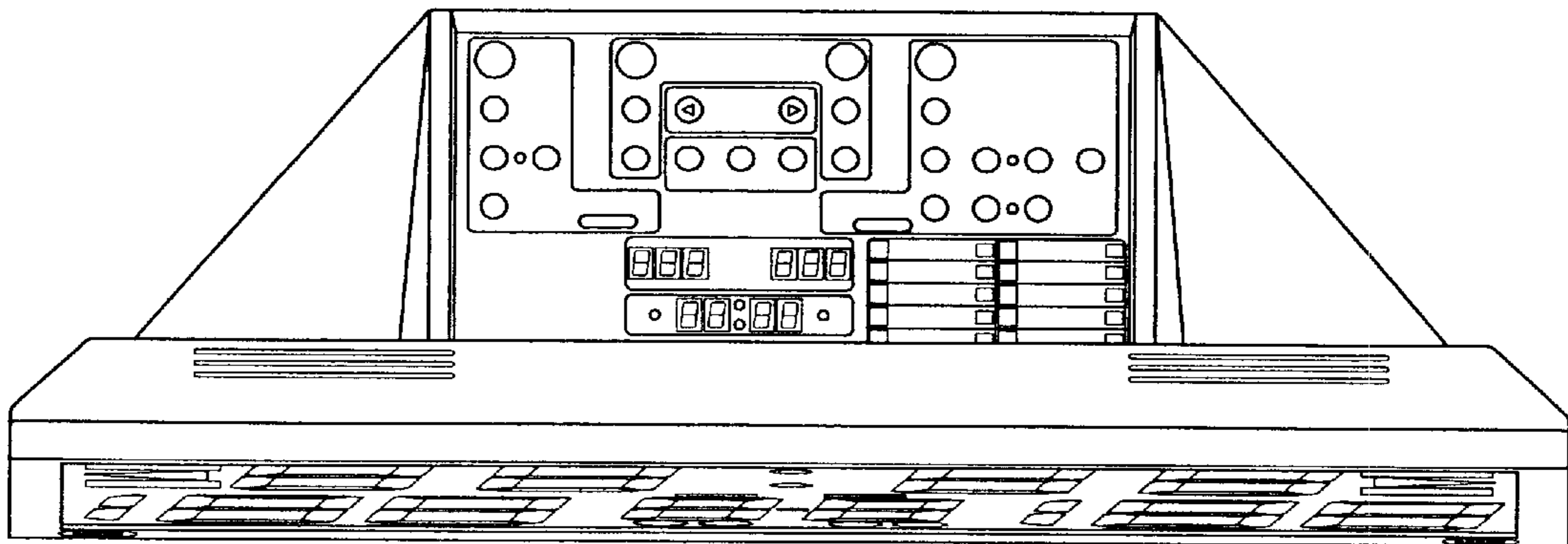

FIG. 4

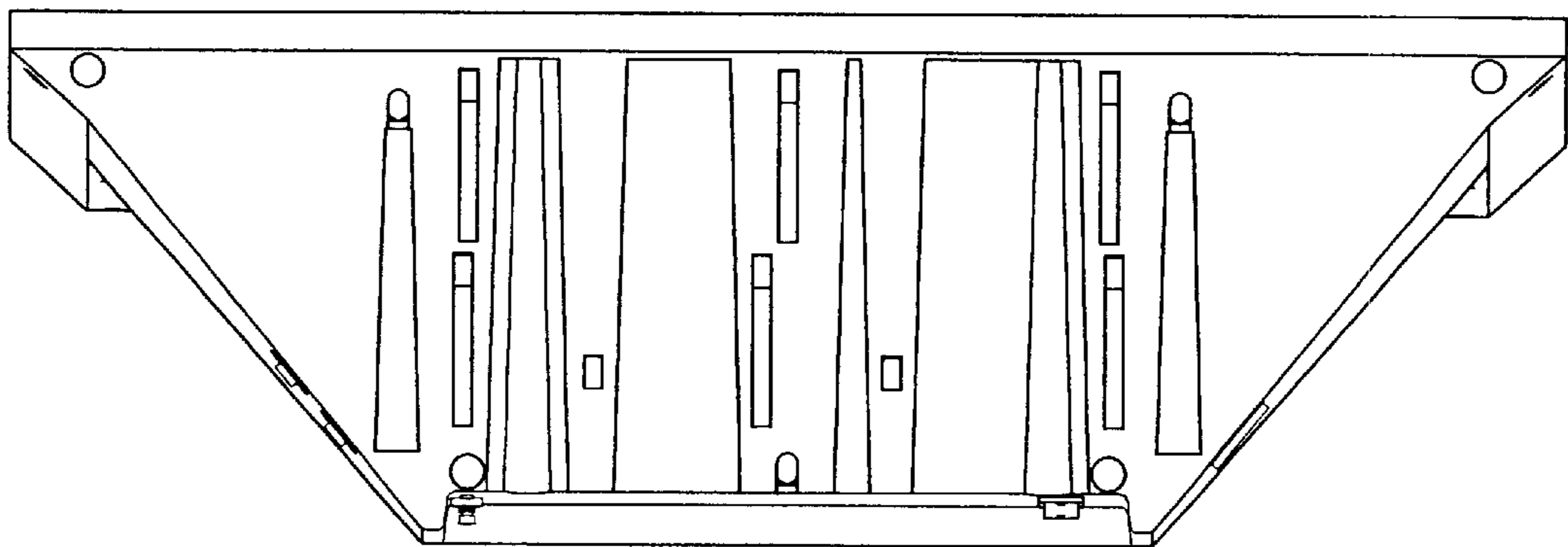

FIG. 5

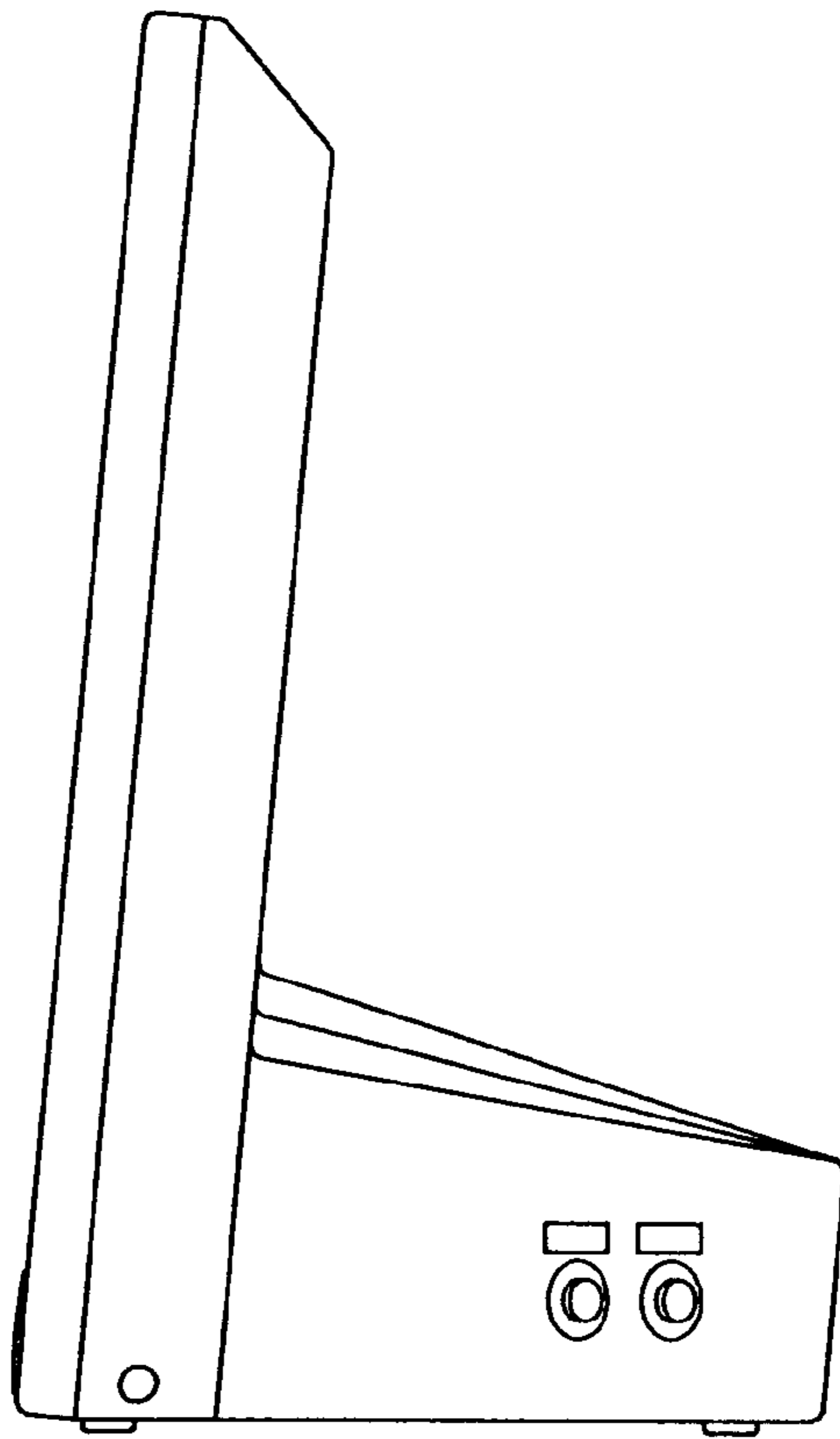

FIG. 6

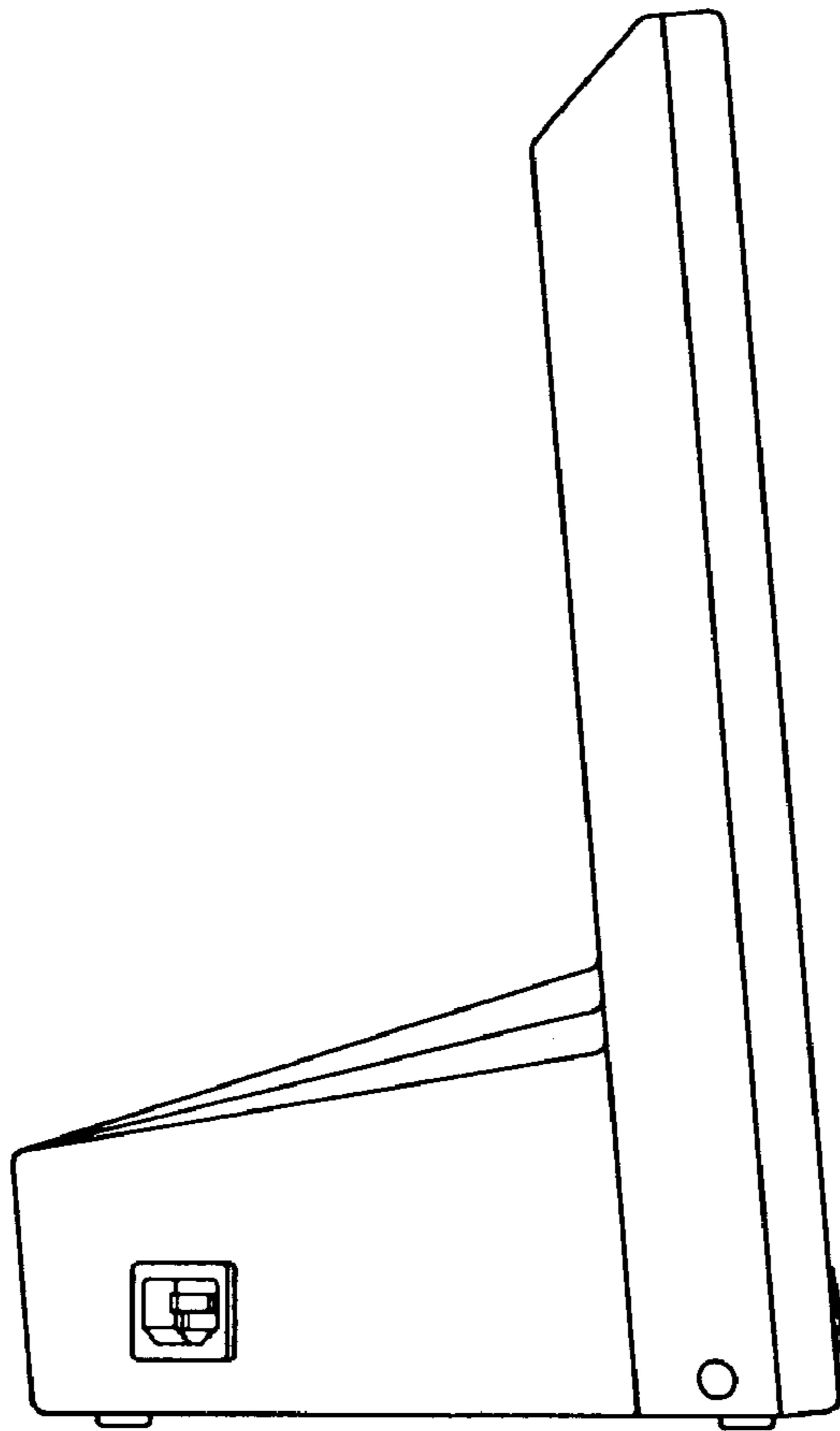



FIG. 7

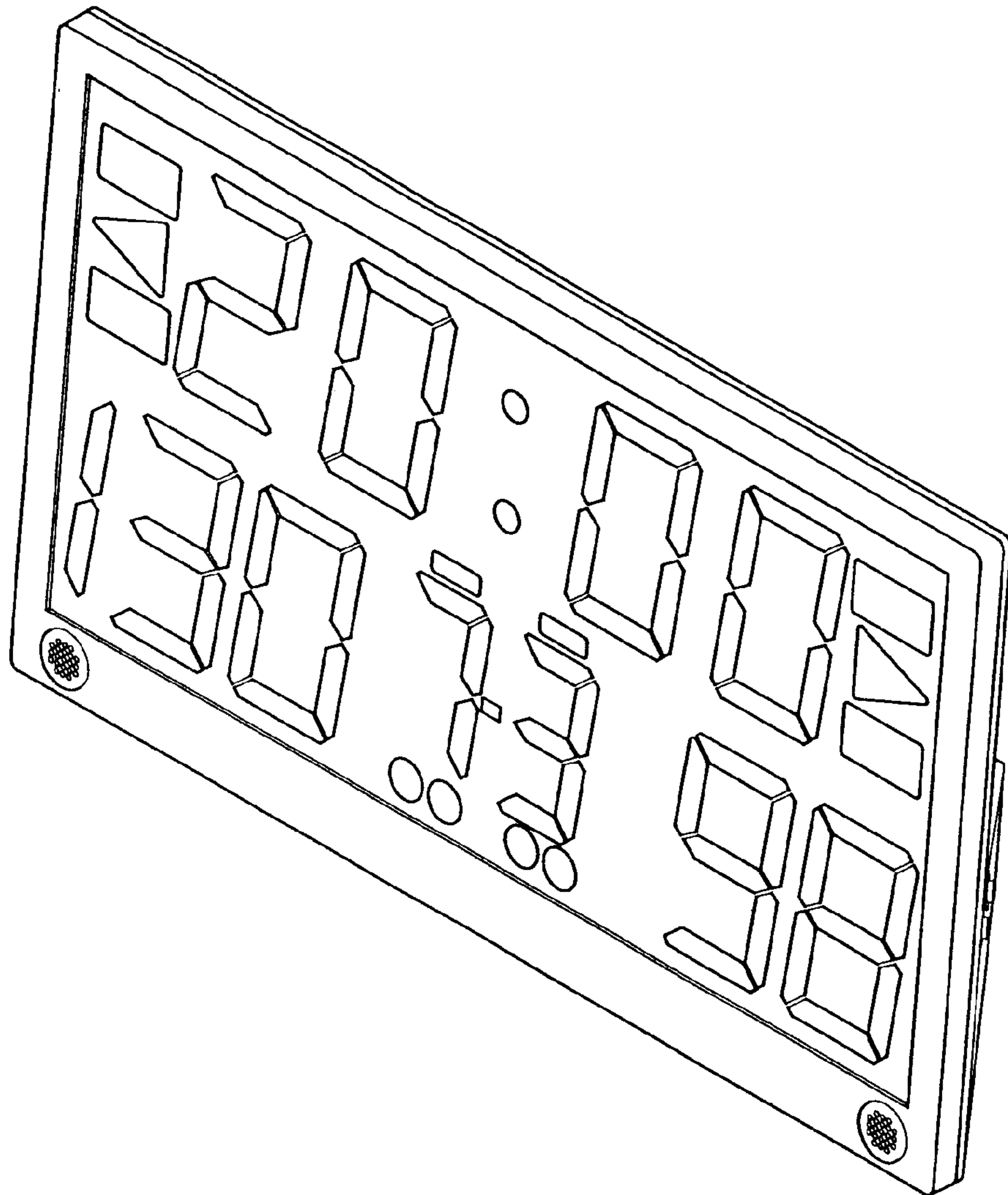



FIG. 8

