



US00D466603S

(12) **United States Design Patent**  
**Pustelnik**

(10) **Patent No.:** **US D466,603 S**

(45) **Date of Patent:** **\*\* Dec. 3, 2002**

(54) **OIL COOLER**

3,765,383 A \* 10/1973 Birdwell, Sr. .... 123/41.5  
5,181,554 A \* 1/1993 Mita ..... 123/41.48

(75) Inventor: **Werner Pustelnik**, Vienna (AT)

\* cited by examiner

(73) Assignee: **ASA Hydraulik Gesellschaft m.b.H.**,  
Vienna (AT)

*Primary Examiner*—Lisa Lichtenstein  
(74) *Attorney, Agent, or Firm*—Karl Hormann

(\*\*) Term: **14 Years**

(57) **CLAIM**

(21) Appl. No.: **29/158,245**

The ornamental design for an oil cooler, as shown.

(22) Filed: **Apr. 1, 2002**

**DESCRIPTION**

(30) **Foreign Application Priority Data**

Oct. 3, 2001 (AT) ..... MU 3803/2001

FIG. 1 is a bottom elevation view of the oil cooler according to my invention;

(51) **LOC (7) Cl.** ..... **23-04**

FIG. 2 is a rear elevation view of the oil cooler of FIG. 1;

(52) **U.S. Cl.** ..... **D23/370**

FIG. 3 is a top elevation view of the oil cooler of FIG. 1;

(58) **Field of Search** ..... D23/370; 165/121,  
165/122; 123/41.42, 41.48

FIG. 4 is a left side elevation view of the oil cooler of FIG. 1;

(56) **References Cited**

FIG. 5 is a right side elevation view of the oil cooler of FIG. 1; and,

**U.S. PATENT DOCUMENTS**

FIG. 6 is a front elevation view of the oil cooler of FIG. 1.

2,436,281 A \* 2/1948 Bartlett et al. .... 123/41.42

**1 Claim, 2 Drawing Sheets**

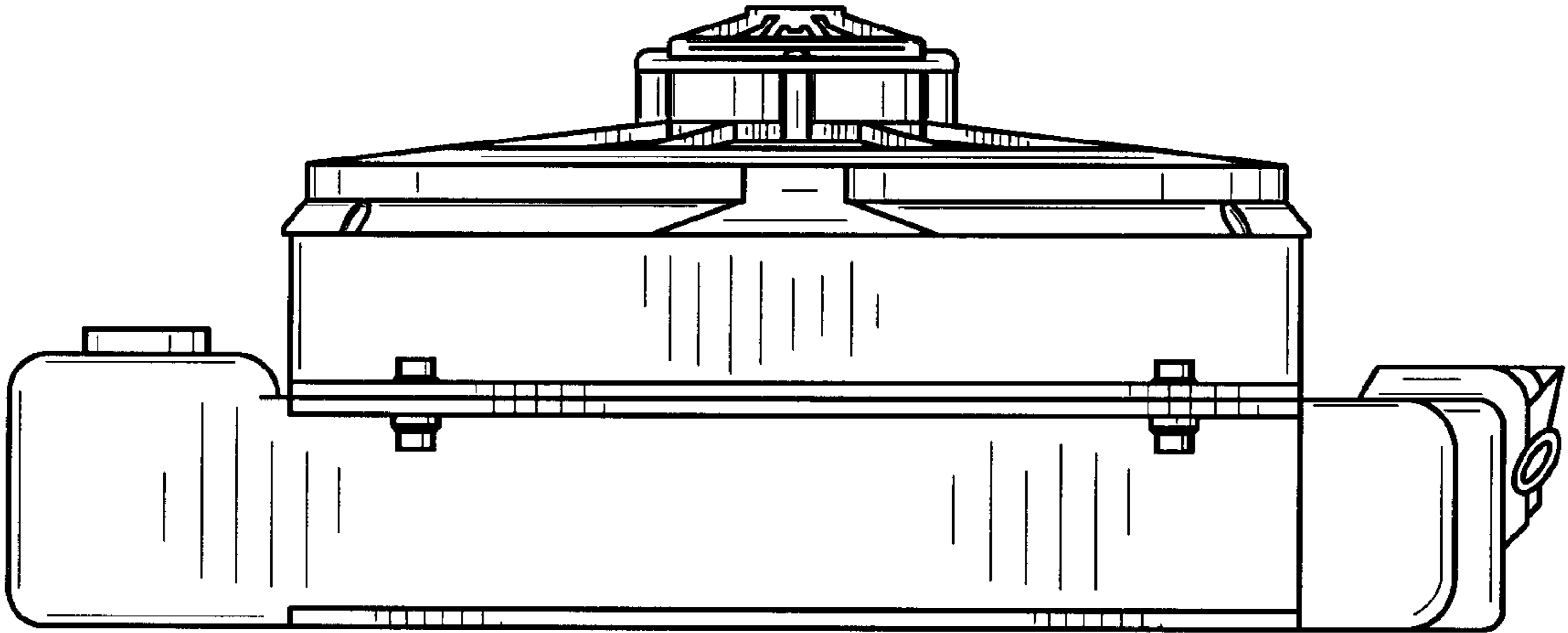

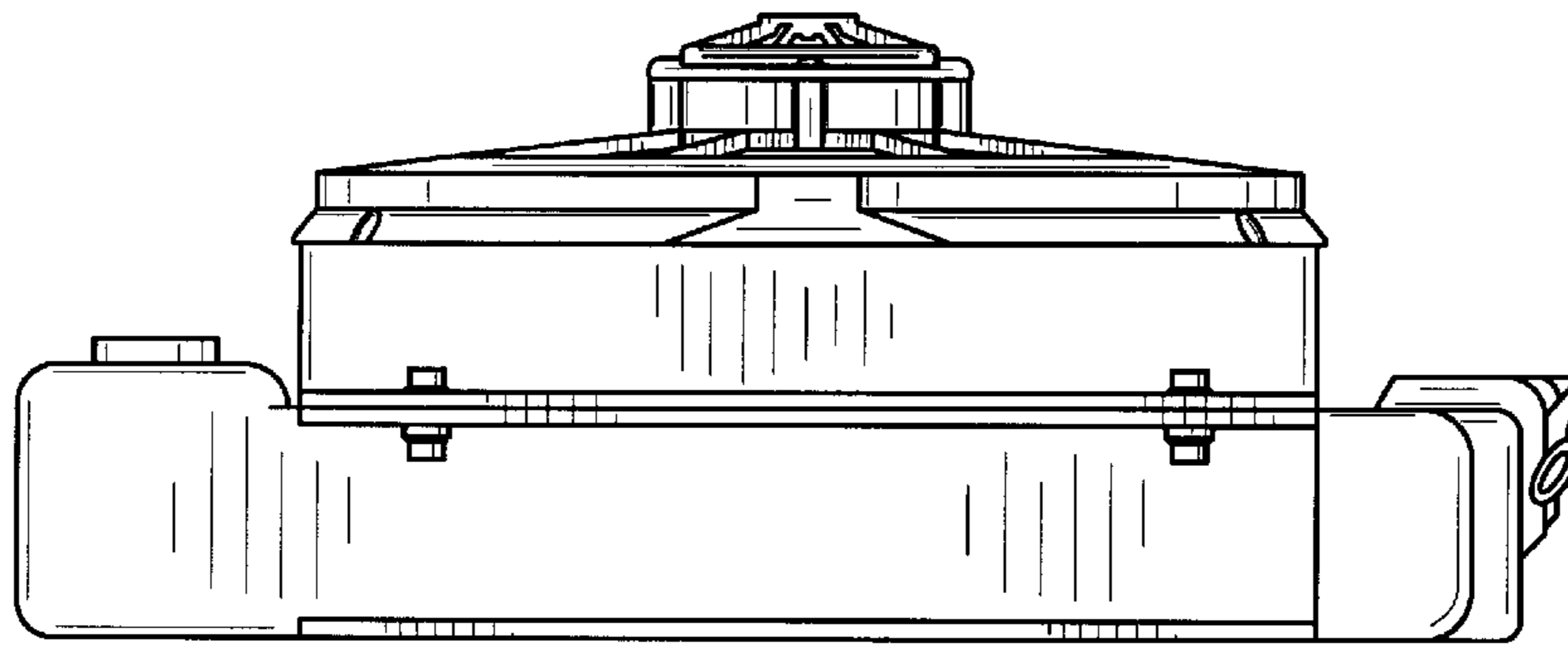

FIG. 1

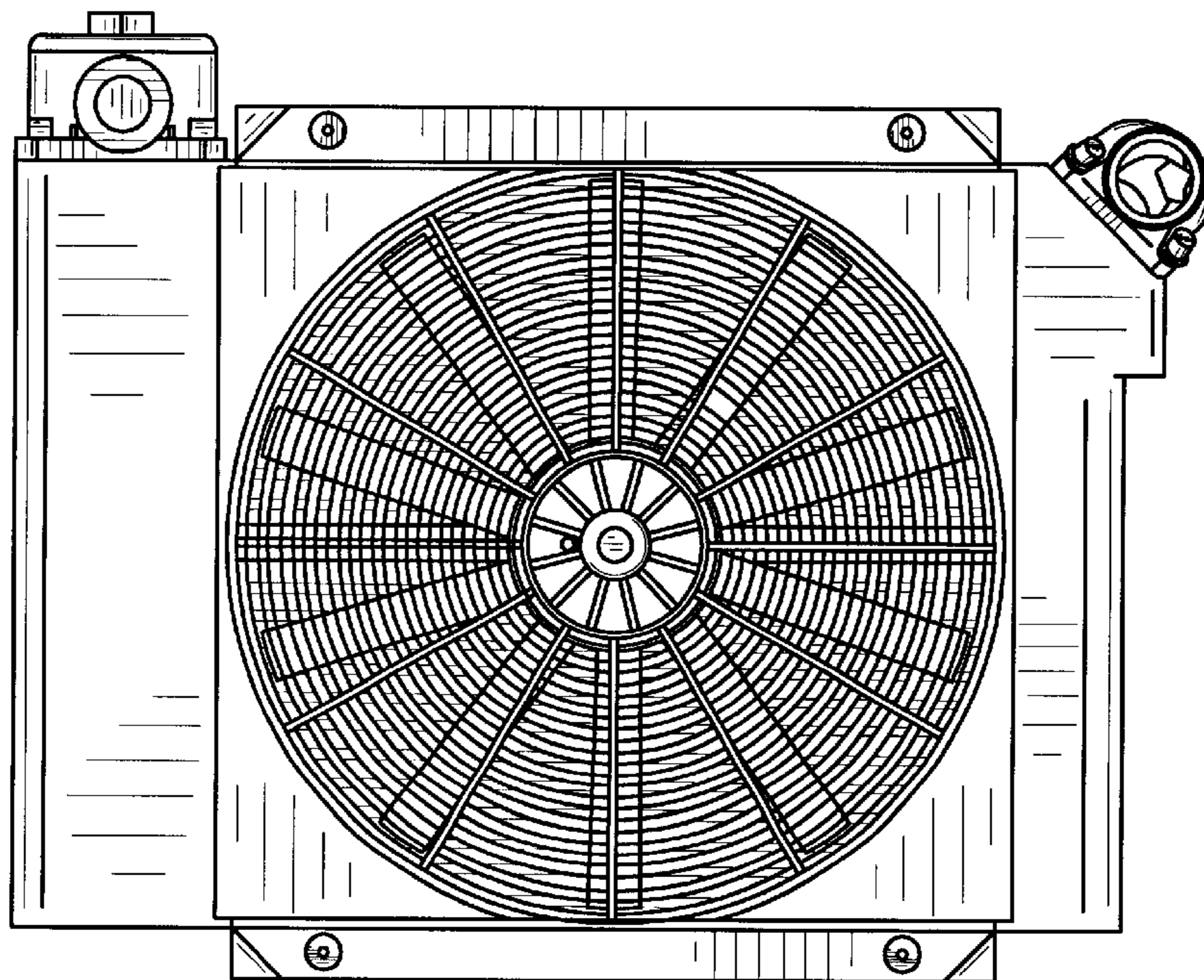

FIG. 2

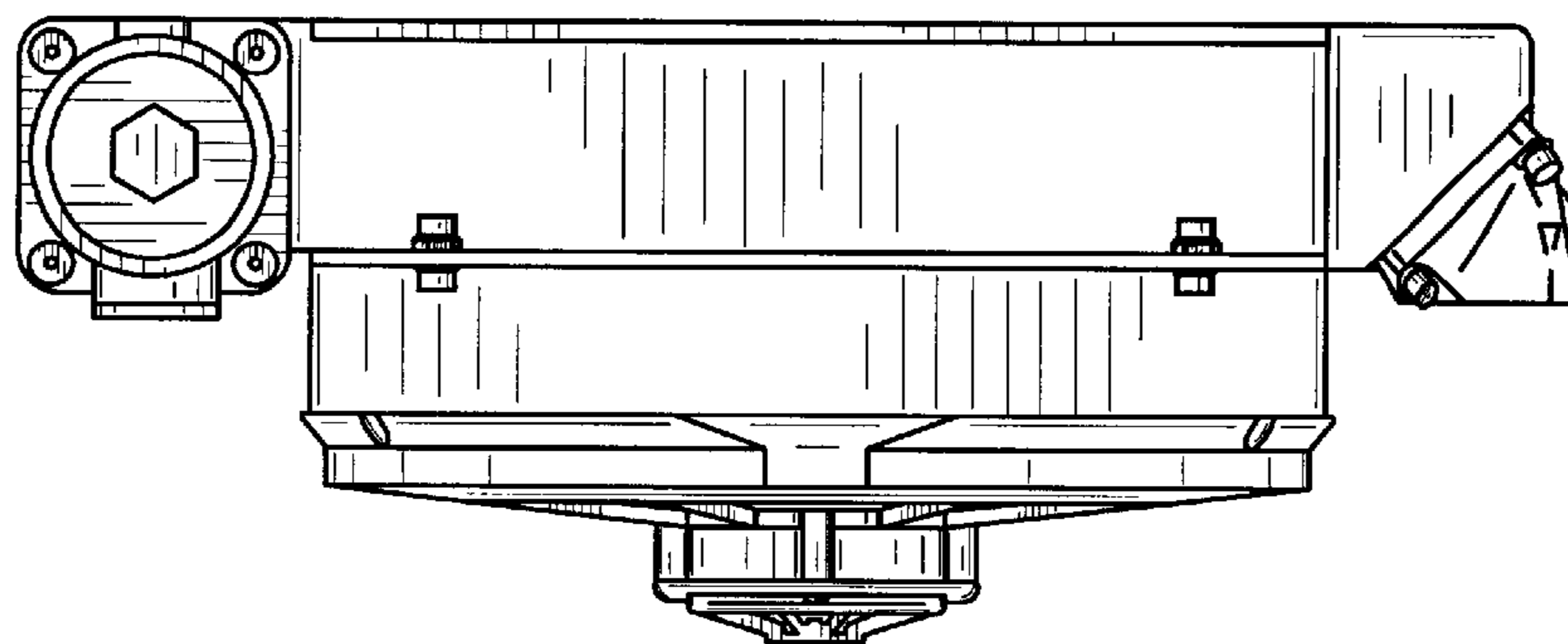

FIG. 3

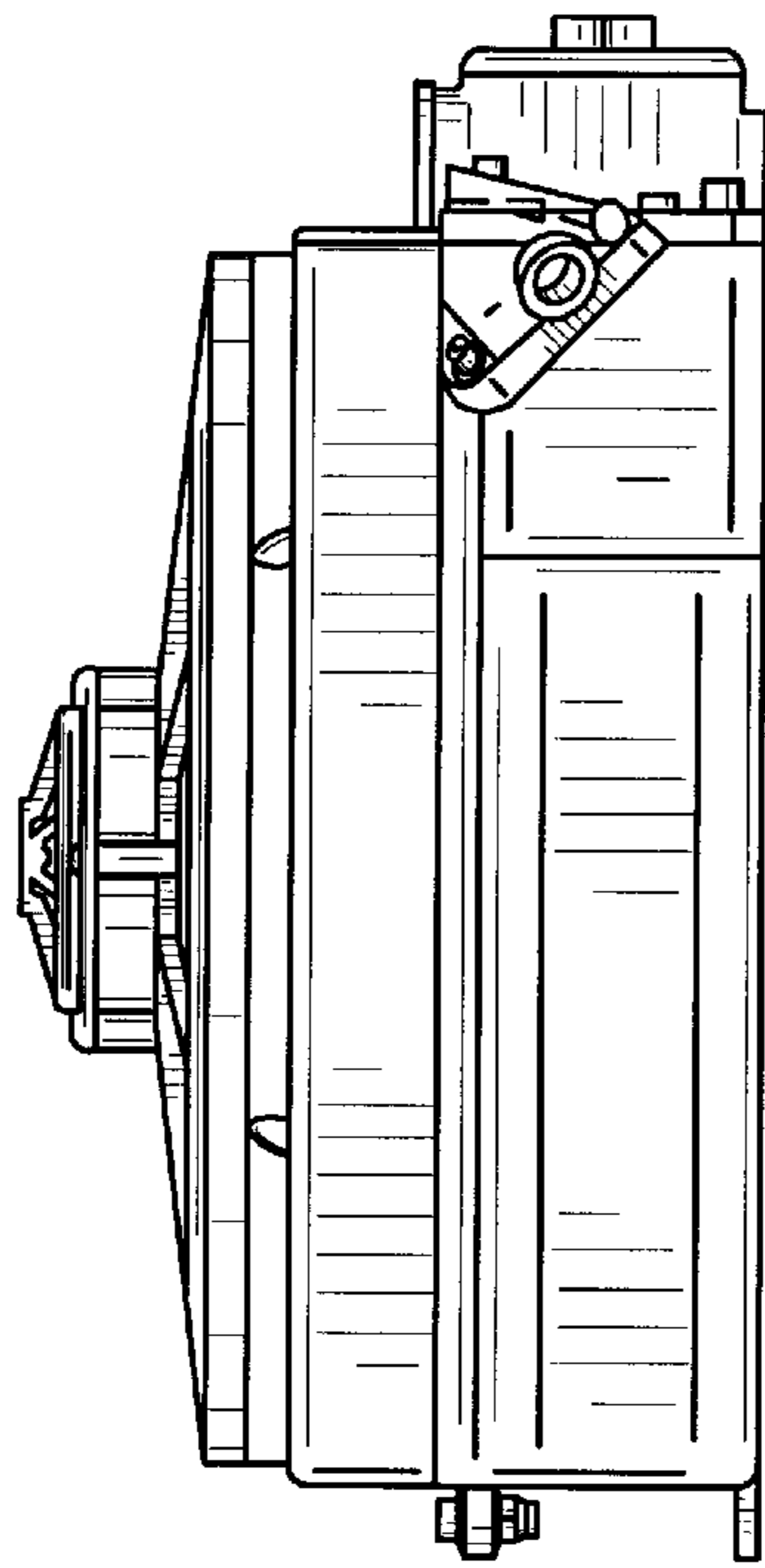

FIG. 4

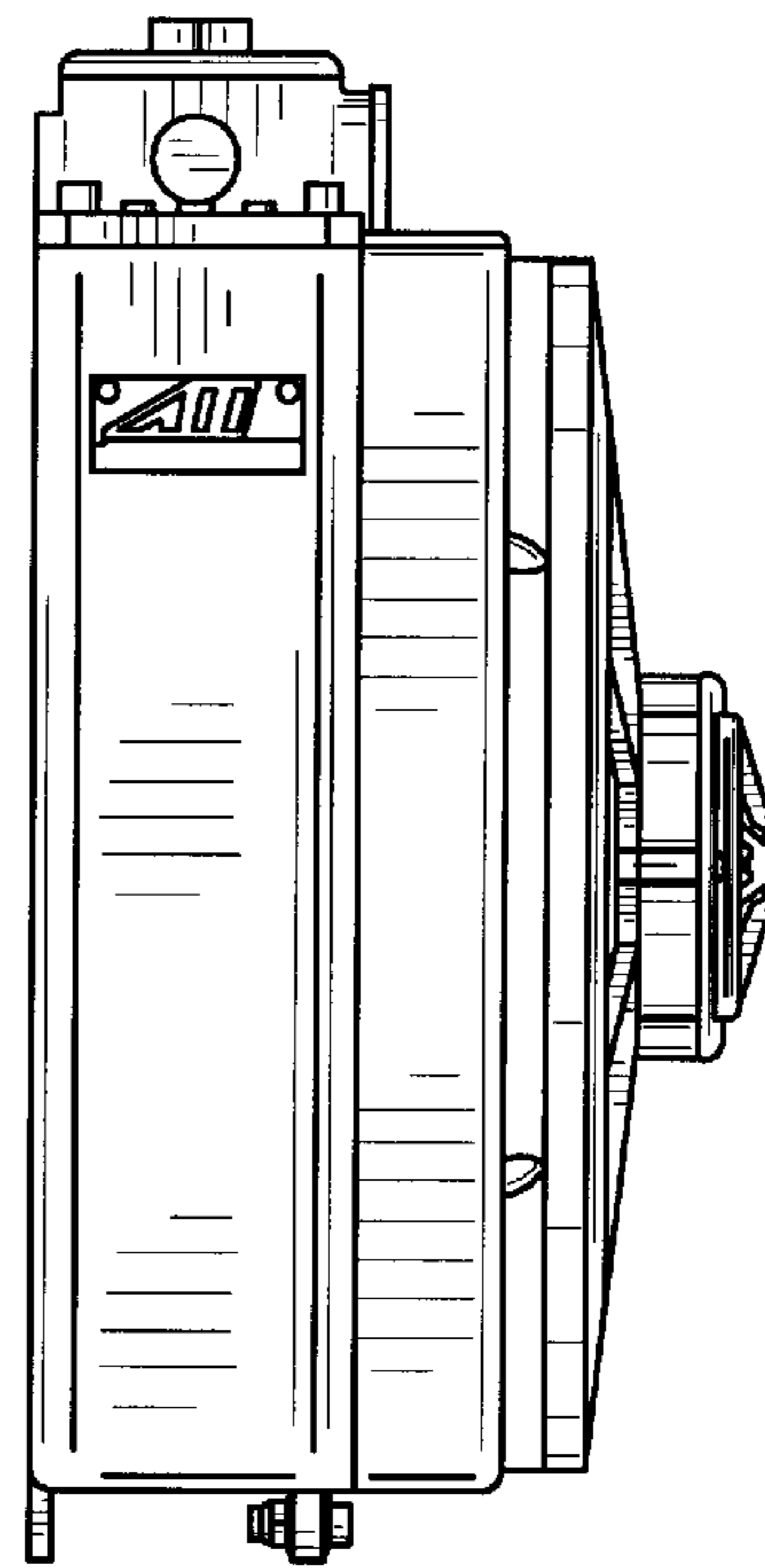

FIG. 5

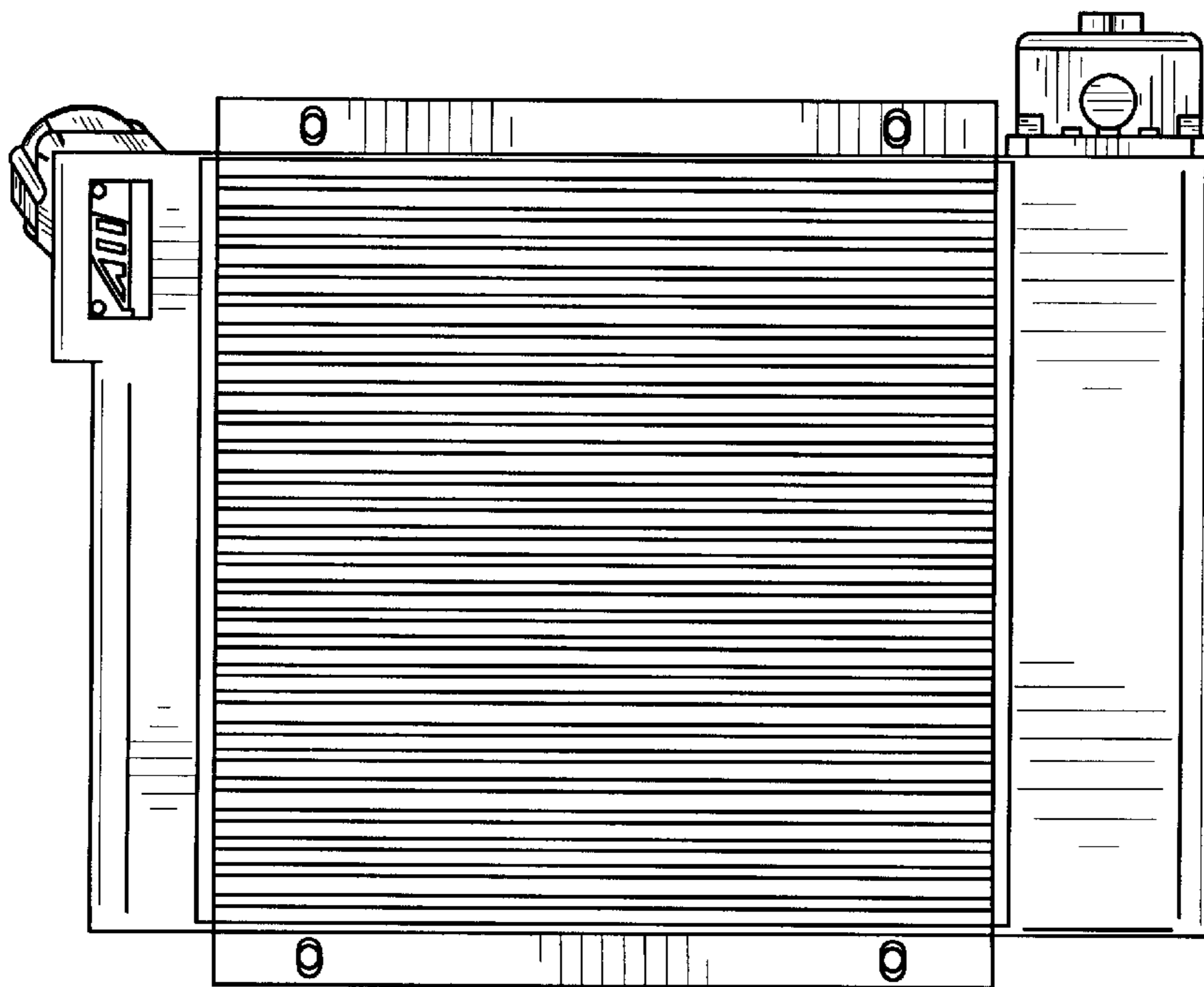

FIG. 6