



US00D466533S

(12) **United States Design Patent**
Kasugai et al.

(10) **Patent No.:** **US D466,533 S**
(45) **Date of Patent:** **** Dec. 3, 2002**

(54) **CONTROL BOX FOR A SEWING MACHINE**

FOREIGN PATENT DOCUMENTS

(75) Inventors: **Shoji Kasugai**, Tokyo (JP); **Keiichi Takikoshi**, Tokyo (JP); **Tomonori Abe**, Tokyo (JP); **Yasuhiro Endo**, Tokyo (JP)

JP 937895 10/1995
JP 1004124 2/1998

* cited by examiner

(73) Assignee: **Mitsubishi Denki Kabushiki Kaisha**, Tokyo (JP)

Primary Examiner—Mitchell Siegel
(74) *Attorney, Agent, or Firm*—Oblon, Spivak, McClelland, Maier & Neustadt, P.C.

(**) Term: **14 Years**

(57) **CLAIM**

(21) Appl. No.: **29/132,980**

The ornamental design for a control box for a sewing machine, as shown.

(22) Filed: **Nov. 21, 2000**

(30) **Foreign Application Priority Data**

DESCRIPTION

May 29, 2000 (JP) 2000-014161

(51) **LOC (7) Cl.** **15-06**

(52) **U.S. Cl.** **D15/72**

(58) **Field of Search** .. D15/69, 72; 112/470.01–470.05, 112/153, 272, 309, 470.29, 470.33, 220, 258

FIG. 1 is a front elevational view of a control box for a sewing machine, showing our new design;
FIG. 2 is a rear elevational view thereof;
FIG. 3 is a top plan view thereof;
FIG. 4 is a bottom plan view thereof;
FIG. 5 is a right side elevational view
FIG. 6 is the left side elevational view thereof;
FIG. 7 is a cross-sectional view thereof, taken along line 7—7 of FIG. 3, with the internal system omitted;
FIG. 8 is a cross-sectional view thereof, taken along line 8—8 of FIG. 3, with the internal system omitted; and,
FIG. 9 is top, front and left side perspective view thereof.

(56) **References Cited**

U.S. PATENT DOCUMENTS

4,074,640 A * 2/1978 Chano et al. 112/470.03
4,100,868 A * 7/1978 Reinecker et al. 112/277
4,104,976 A * 8/1978 Landau et al. 112/470.02
5,269,239 A * 12/1993 Adamski, Jr. et al. .. 112/470.29
5,551,360 A * 9/1996 Qui 112/470.01

1 Claim, 5 Drawing Sheets

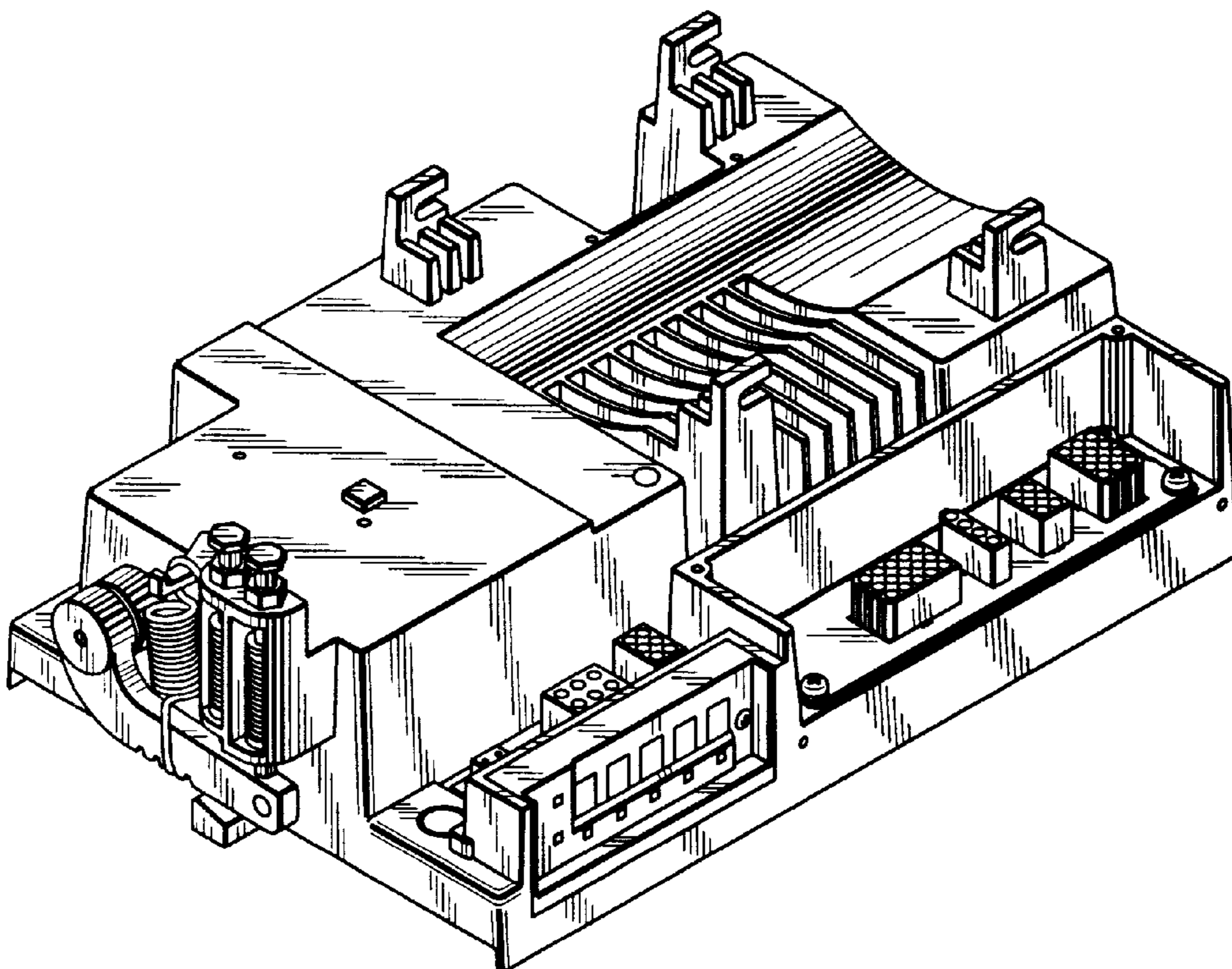

FIG. 1

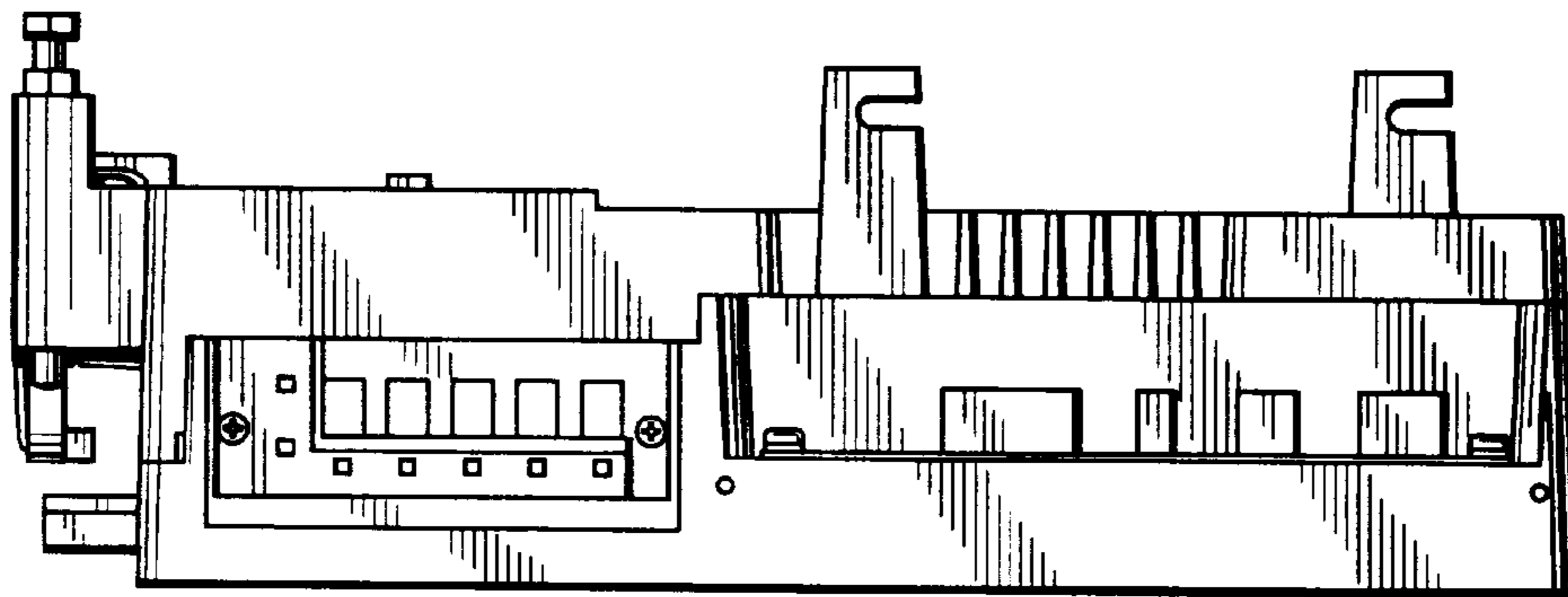

FIG. 2

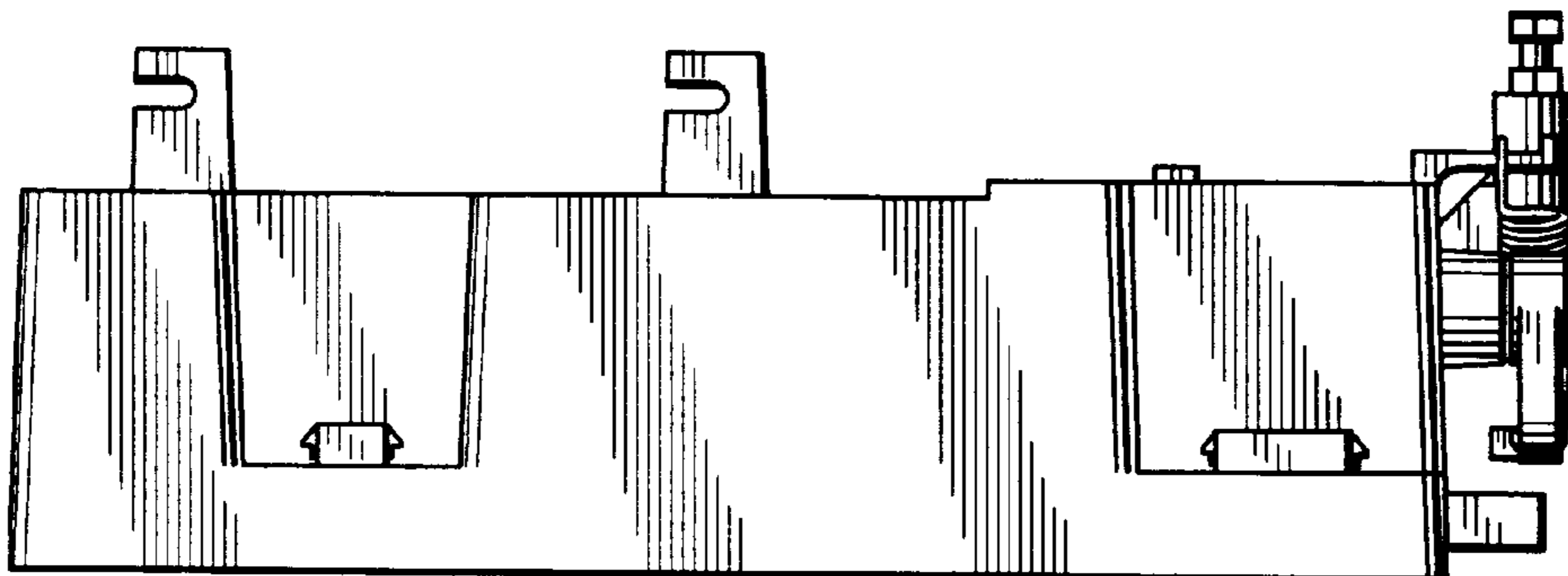

FIG.3

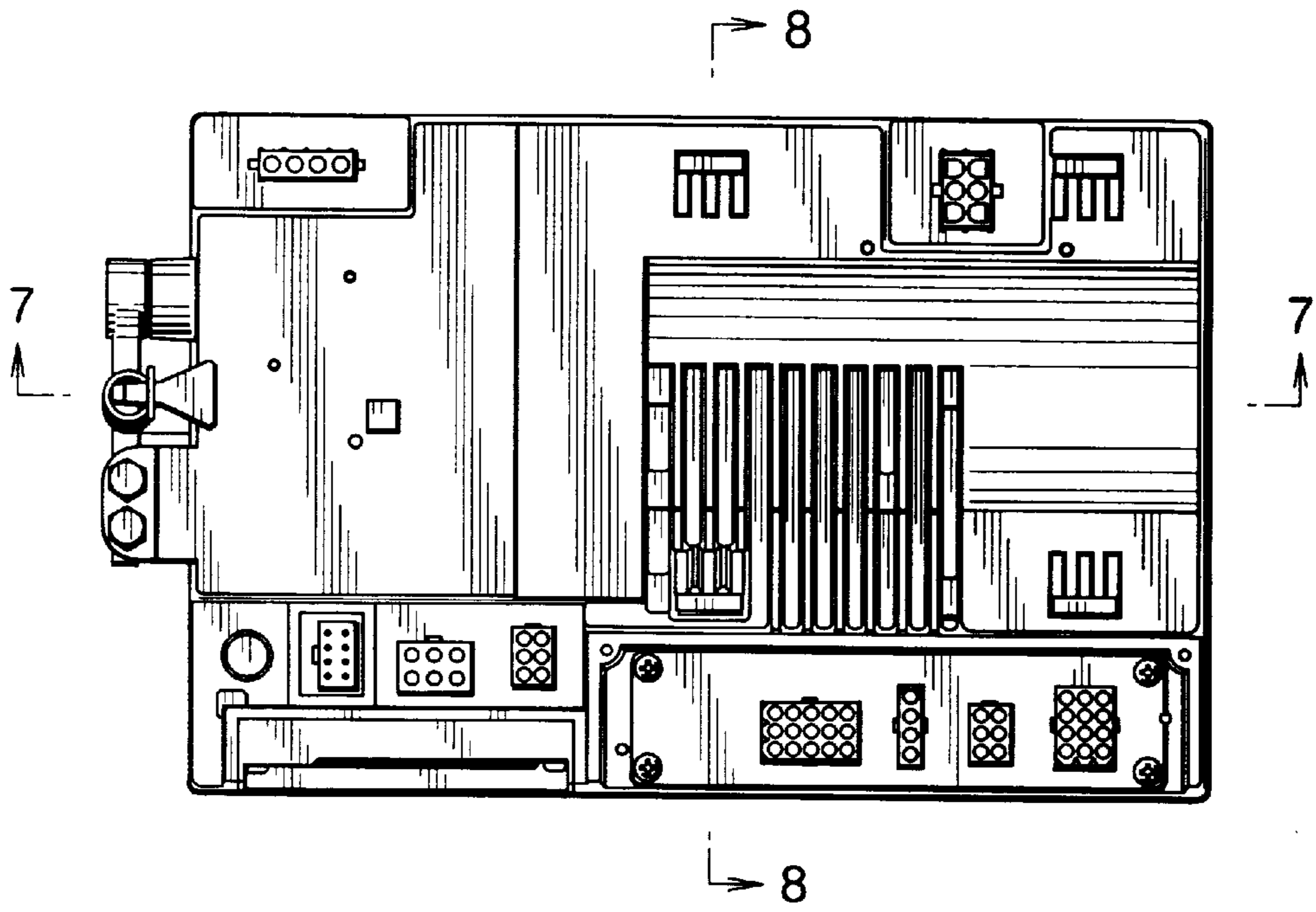

FIG.4

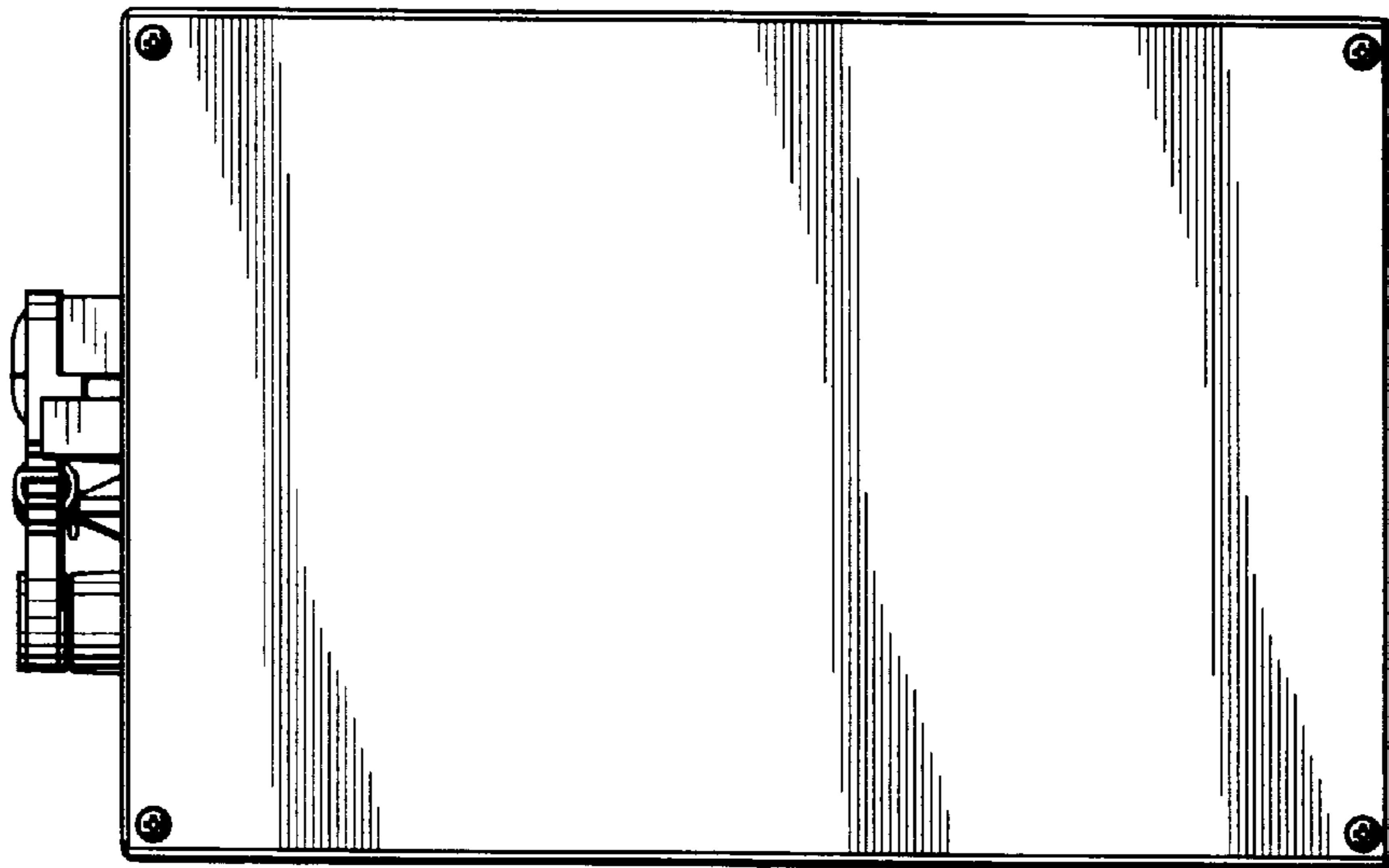

FIG.5

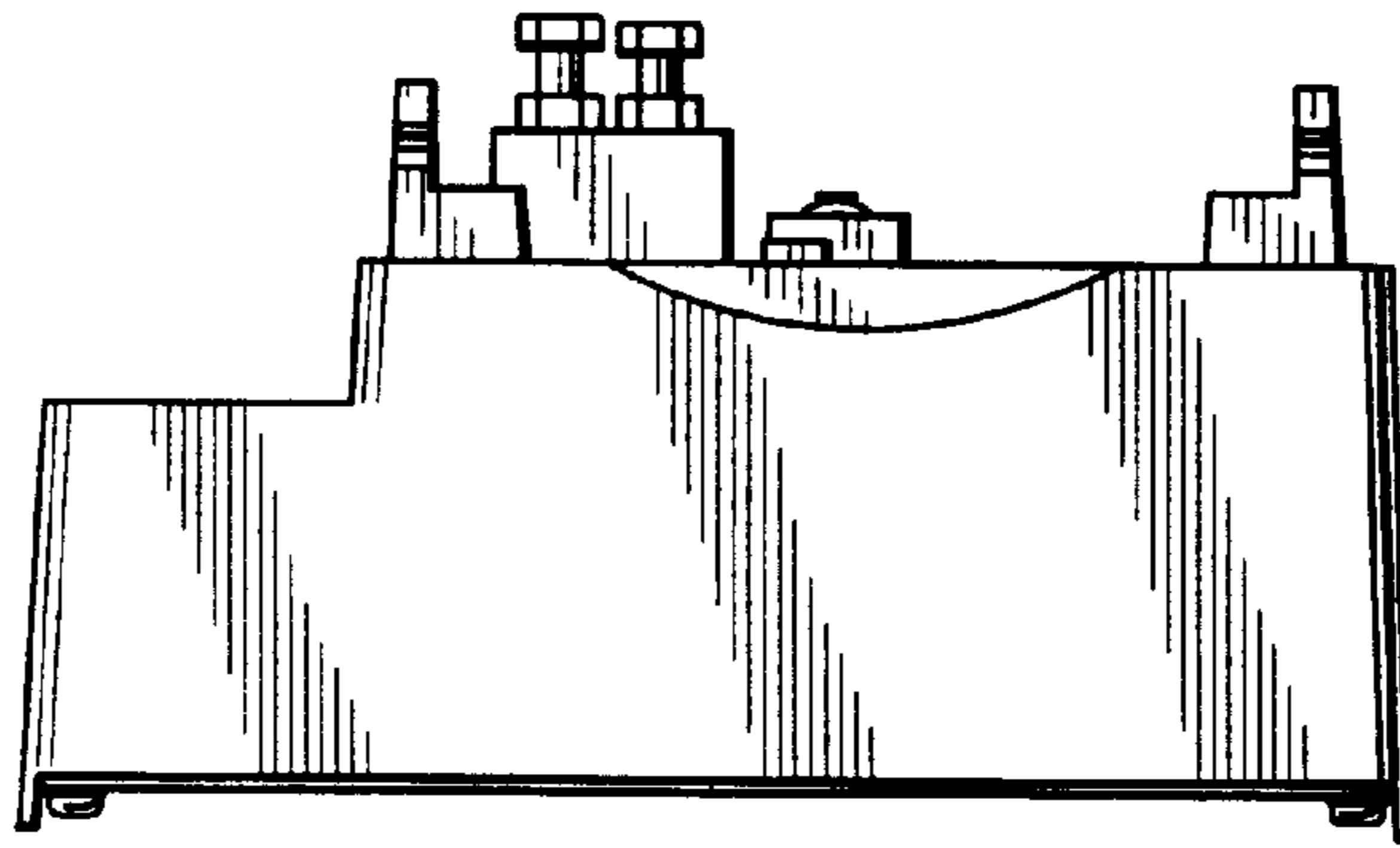

FIG.6

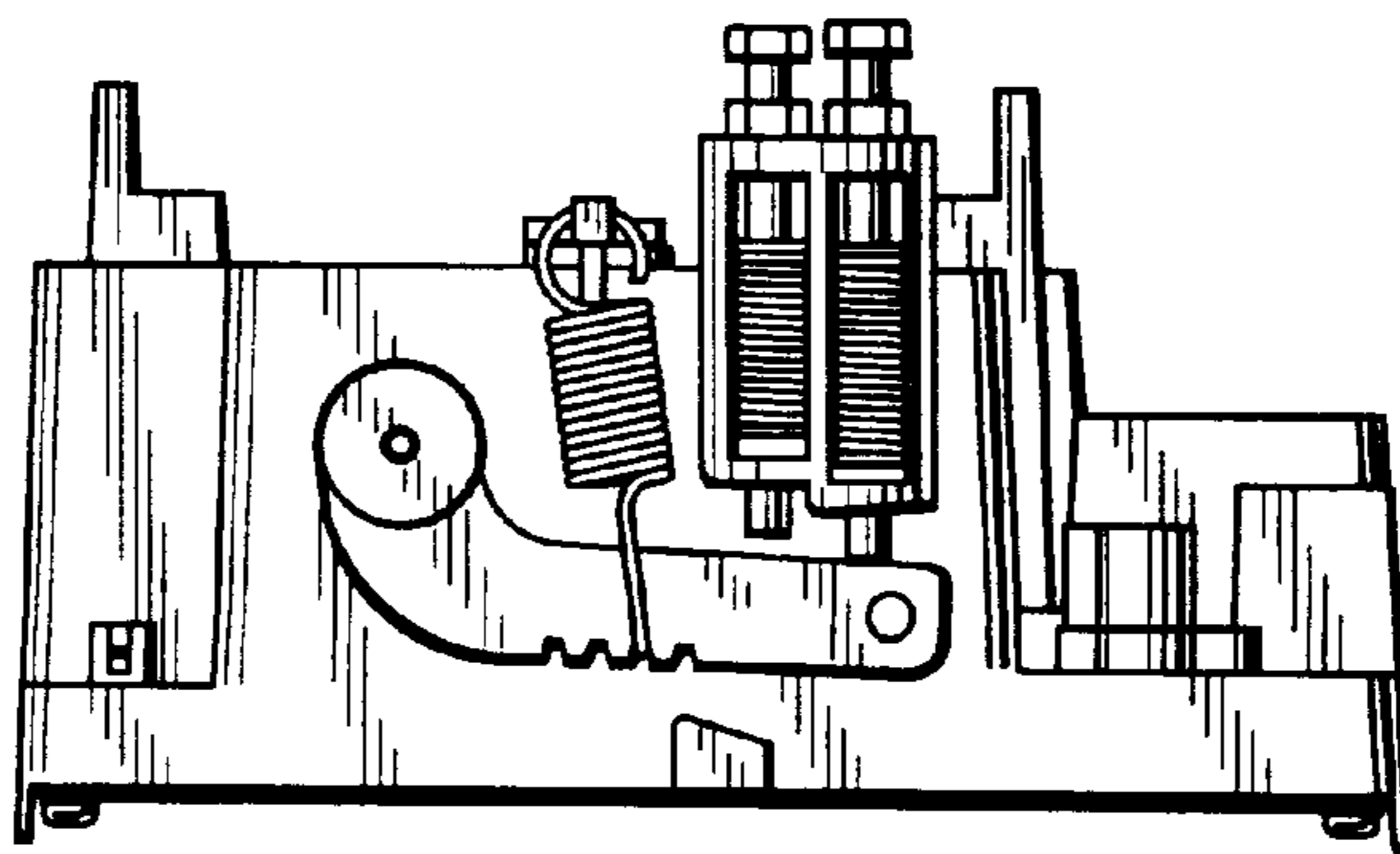

FIG. 7

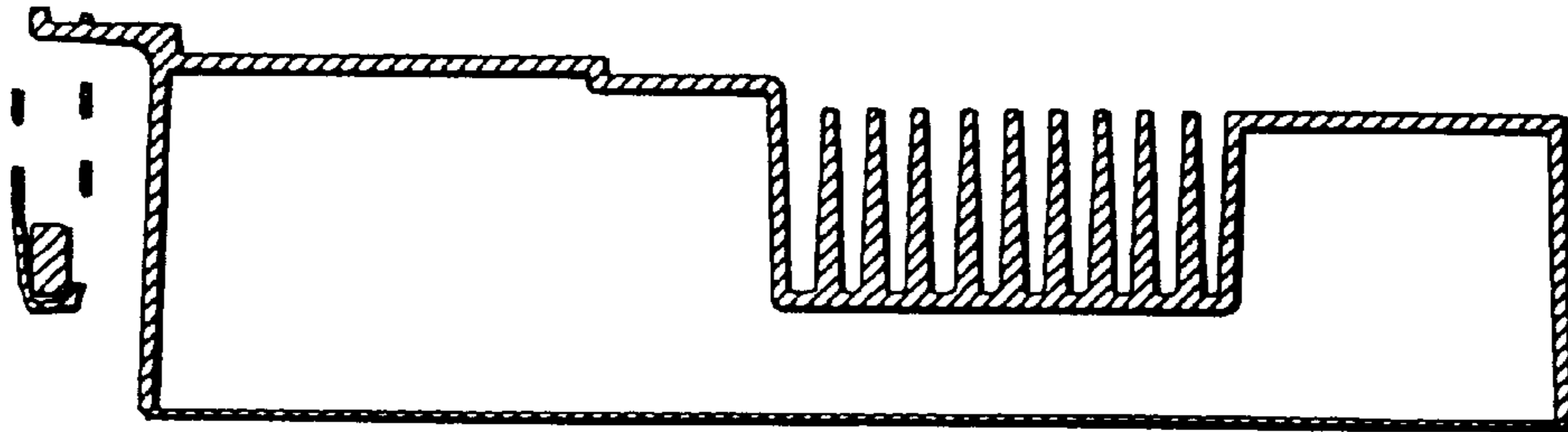

FIG. 8

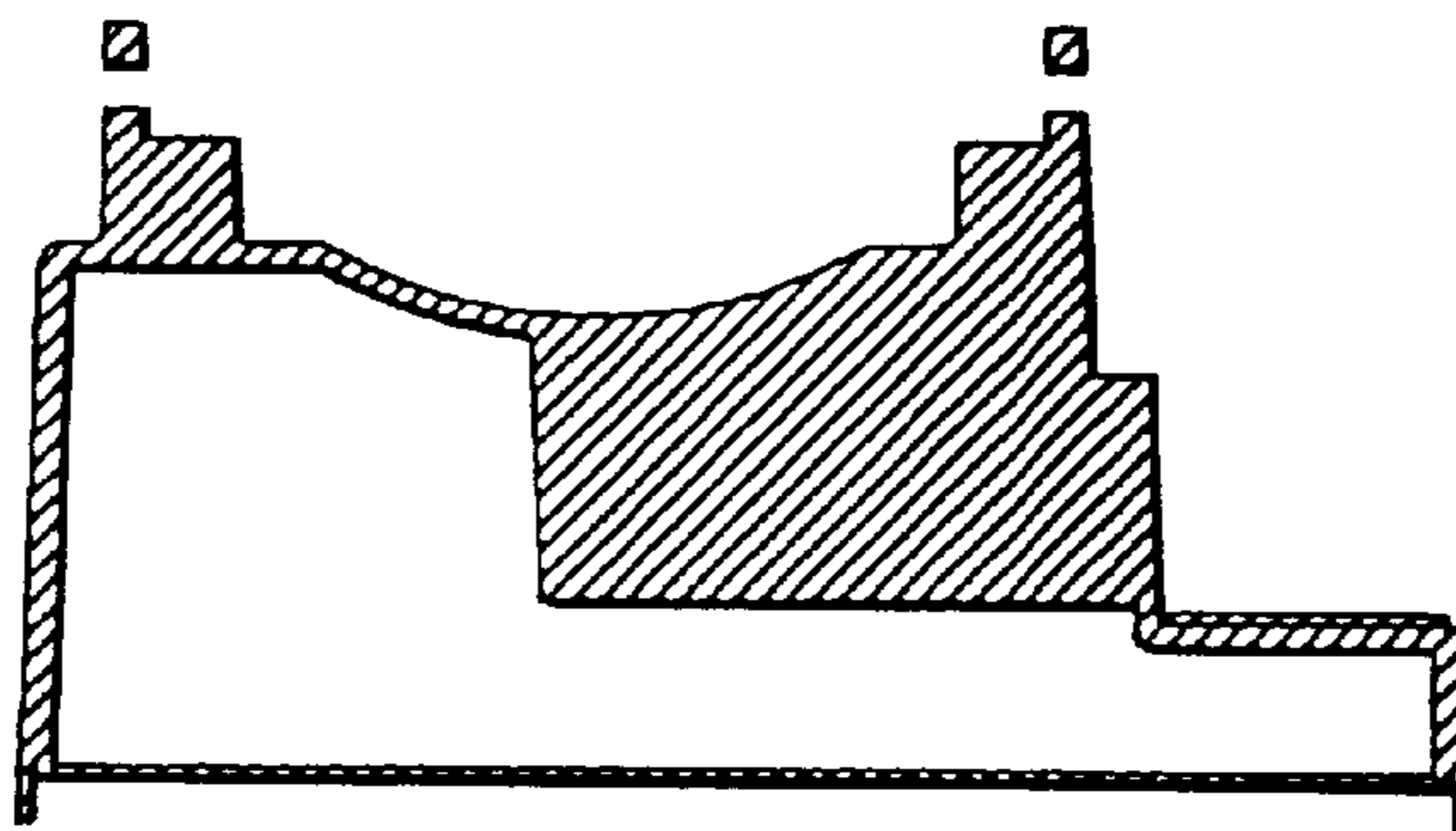

FIG. 9

