



US00D466490S

(12) **United States Design Patent**
Zeitman

(10) **Patent No.:** **US D466,490 S**

(45) **Date of Patent:** **** Dec. 3, 2002**

(54) **CD PLAYER**

D432,514 S * 10/2000 Nakamura et al. D14/156
D433,672 S * 11/2000 Kobayashi D14/156

(75) Inventor: **Josh Zeitman**, Brooklyn, NY (US)

* cited by examiner

(73) Assignee: **Lenox Electronics Corp.**, Brooklyn, NY (US)

Primary Examiner—Nanda Bondade

(**) Term: **14 Years**

(74) *Attorney, Agent, or Firm*—Burns, Doane, Swecker & Mathis, L.L.P.

(21) Appl. No.: **29/143,162**

(57) **CLAIM**

(22) Filed: **Jun. 11, 2001**

The ornamental design for a “CD player”, as shown and described.

(51) **LOC (7) Cl.** **14-01**

DESCRIPTION

(52) **U.S. Cl.** **D14/156**

(58) **Field of Search** D14/135–136,
D14/156, 157, 160, 167–168; 369/75.1,
75.2, 77.1, 77.2

FIG. 1 is a front view of a “CD player” showing my design;
FIG. 2 is a rear view thereof;
FIG. 3 is a left side view thereof;
FIG. 4 is a right side view thereof;
FIG. 5 is a top plan view thereof; and,
FIG. 6 is a bottom view thereof.

(56) **References Cited**

U.S. PATENT DOCUMENTS

D400,876 S * 11/1998 Masamitsu D14/156
6,028,737 A * 2/2000 Khuu 369/77.2 X

1 Claim, 4 Drawing Sheets

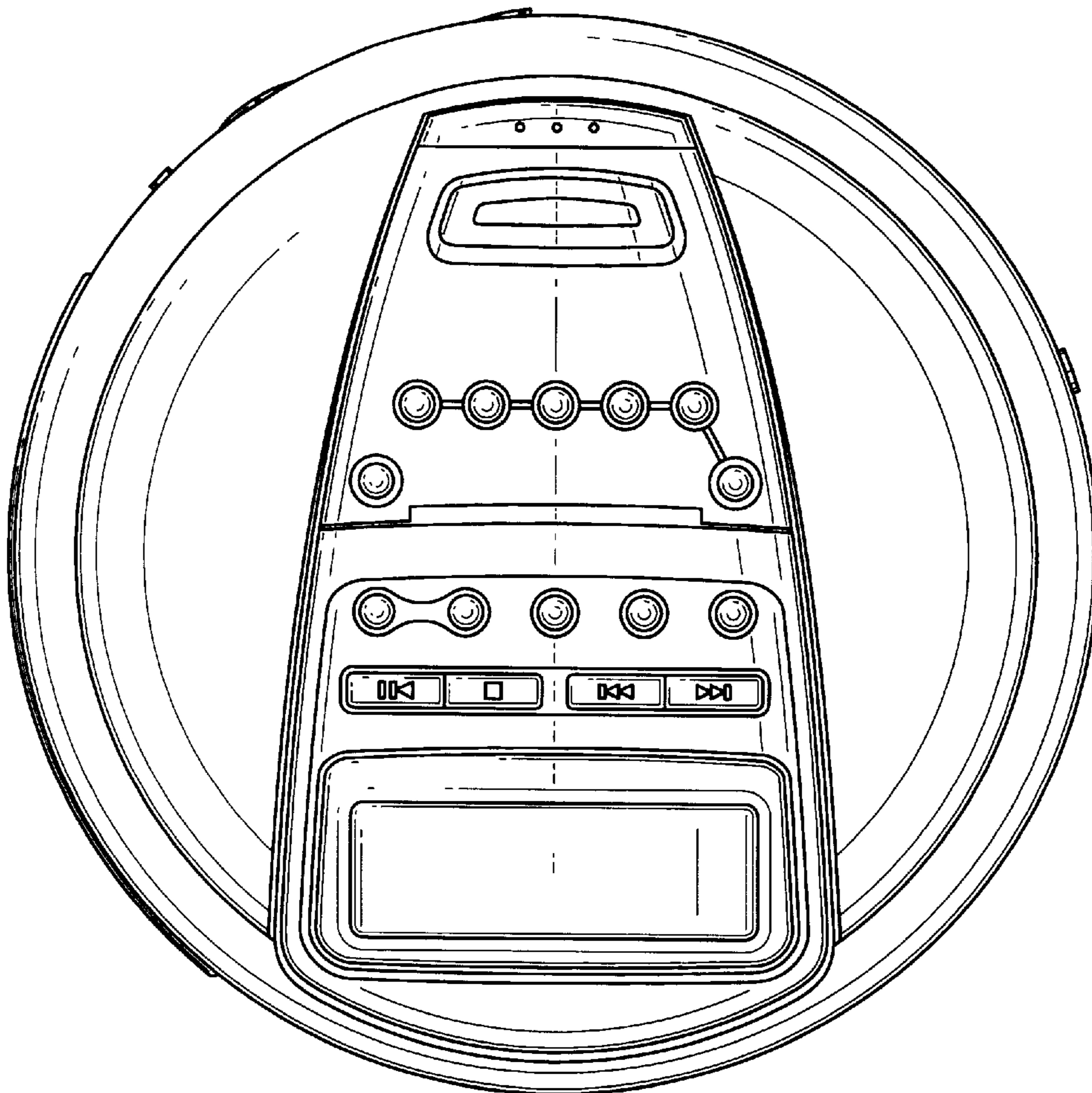

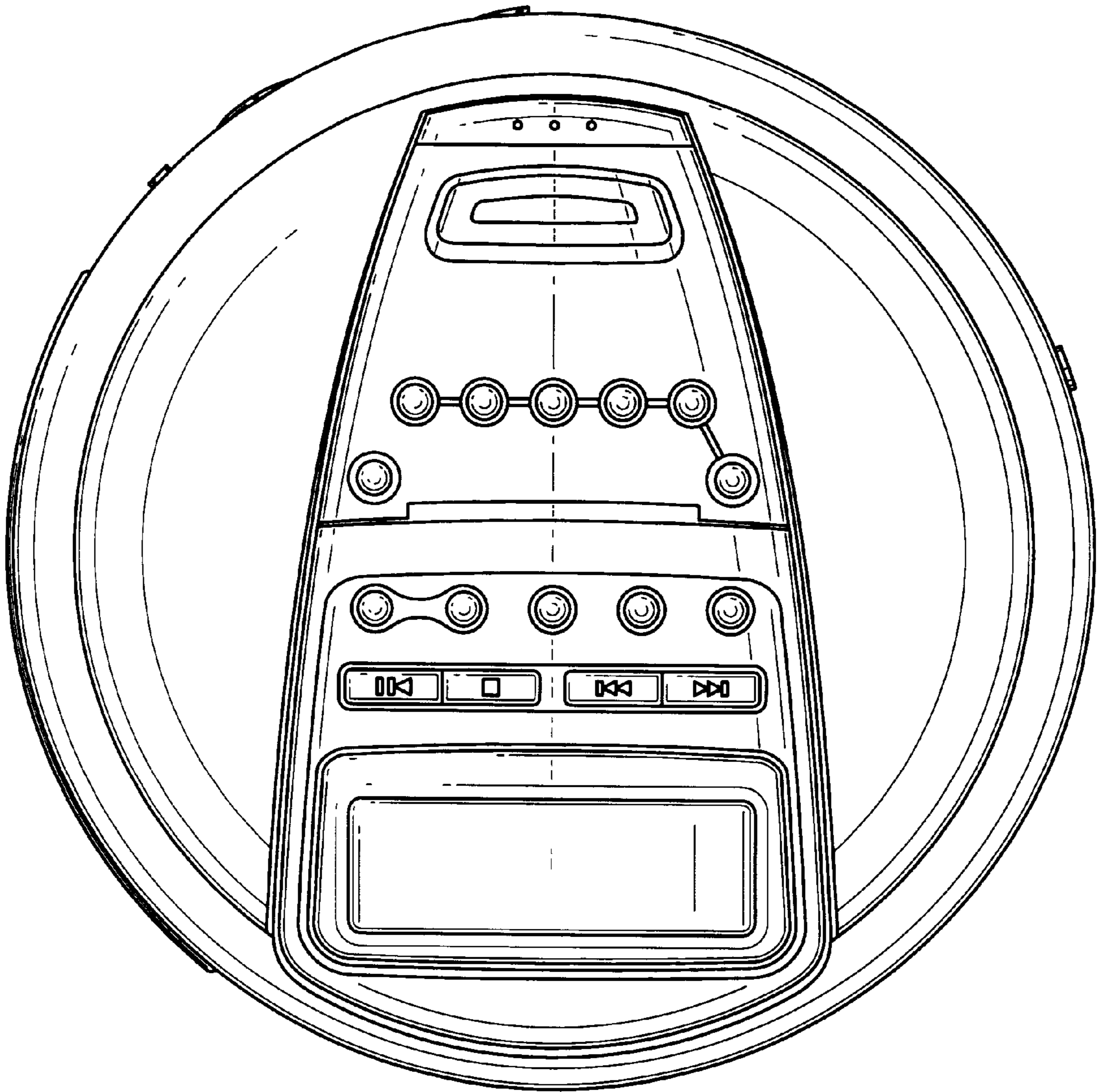

FIG. 1

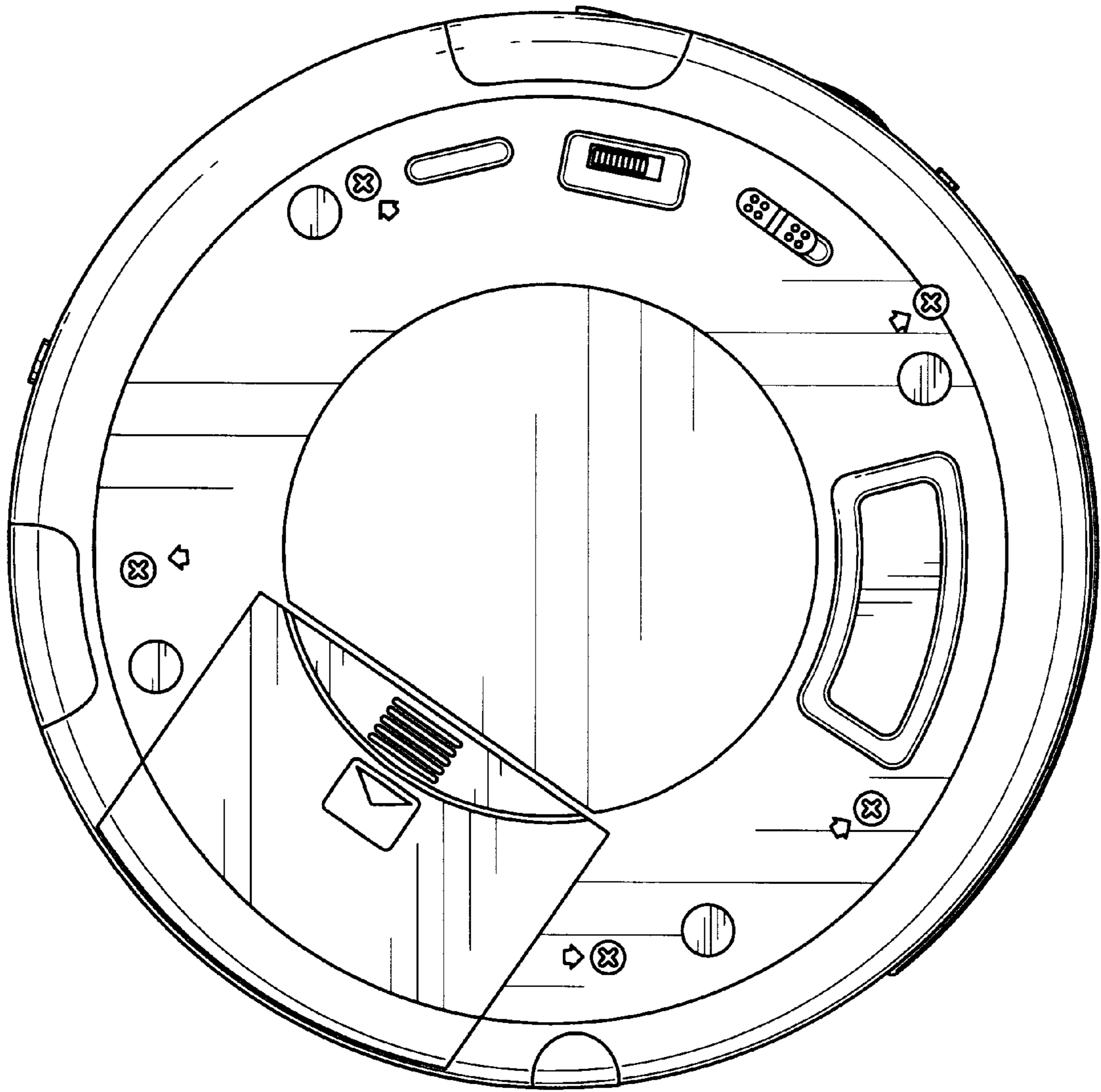

FIG. 2

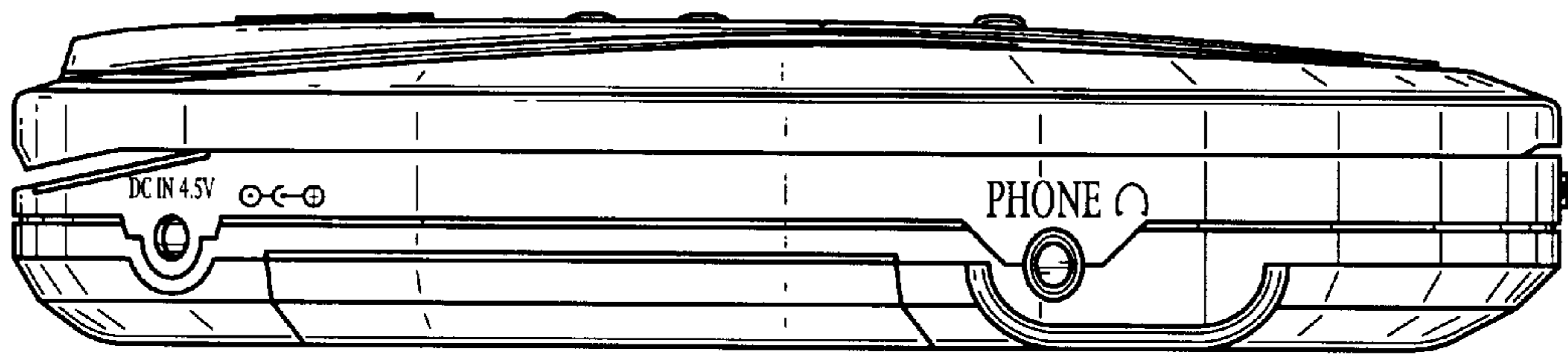

FIG. 3

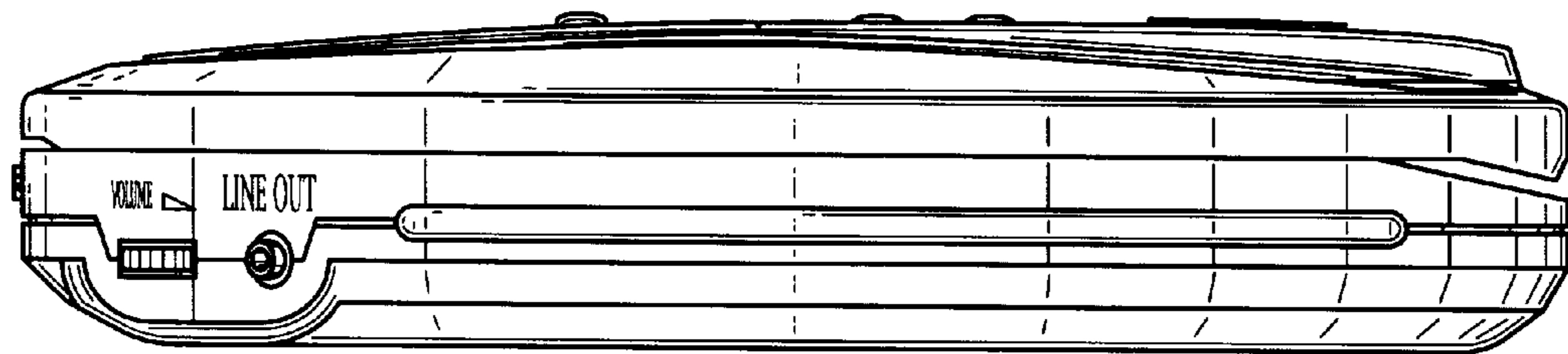

FIG. 4

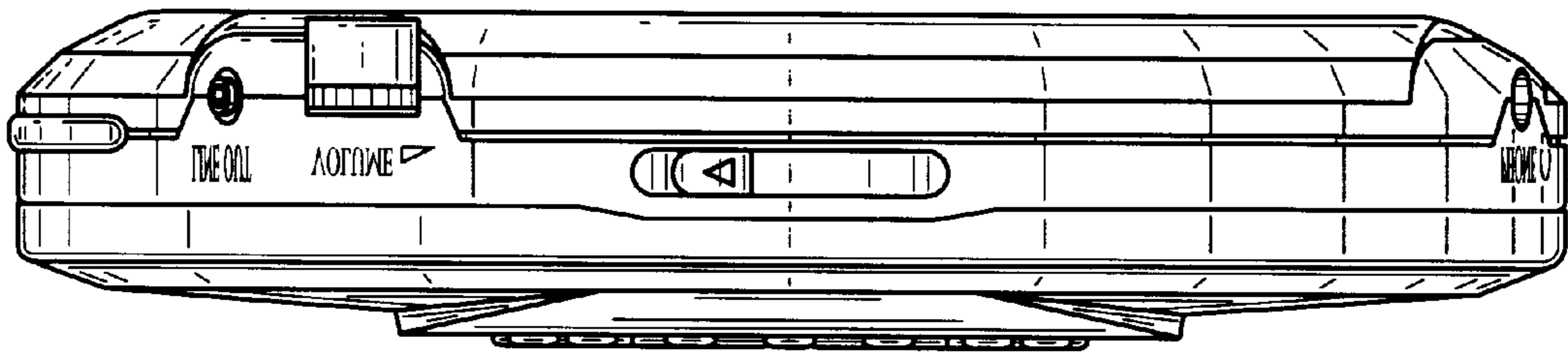

FIG. 5

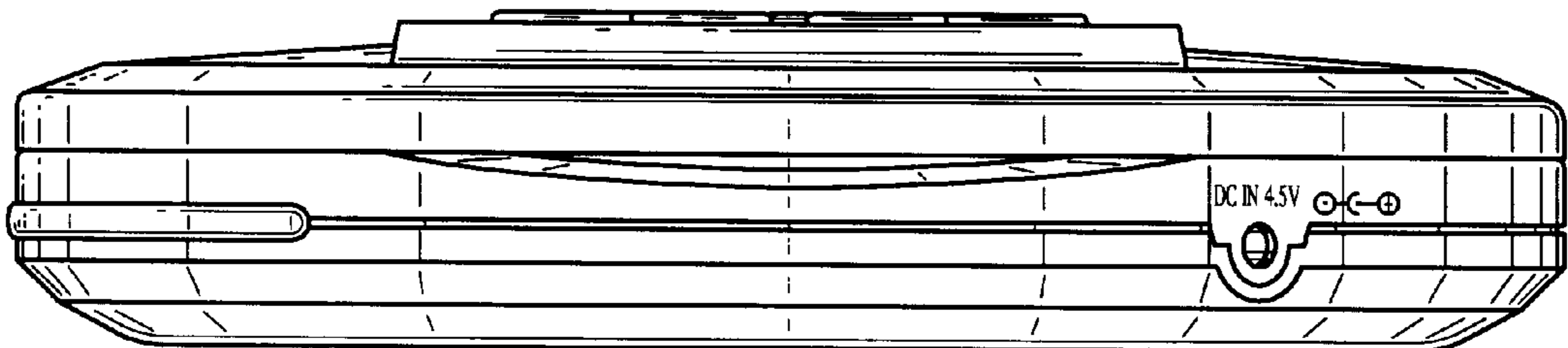

FIG. 6