



US00D466379S

(12) **United States Design Patent**
Barbi et al.

(10) **Patent No.: US D466,379 S**

(45) **Date of Patent: ** Dec. 3, 2002**

(54) **TRANSPARENT PLANT STAKE WITH
TRANSPARENT TIE MEMBER**

(75) **Inventors: Mary Jo Barbi**, 882 Sumter Dr.,
Yardley, PA (US) 19067; **Barbara
Sullivan**, 1808 Yardley Rd., Yardley, PA
(US) 19067; **James Bond Godshalk**,
Yardley, PA (US)

(73) **Assignees: Mary Jo Barbi**, Yardley, PA (US);
Barbara Sullivan, Yardley, PA (US)

(**) **Term: 14 Years**

(21) **Appl. No.: 29/147,950**

(22) **Filed: Sep. 11, 2001**

(51) **LOC (7) Cl. 06-99**

(52) **U.S. Cl. D8/1; D6/403**

(58) **Field of Search** D6/403, 405, 417;
D8/1; D11/143, 144; D22/147, 148; D34/5;
47/44, 45, 46, 47; 248/27.8; 206/423

(56) **References Cited**

U.S. PATENT DOCUMENTS

831,197	A	*	9/1906	Teute	47/47
879,047	A	*	2/1908	Heubner	47/47
1,875,137	A	*	8/1932	Polock	47/47
1,875,618	A	*	9/1932	Lenon	D8/1
2,242,168	A	*	5/1941	Bergman	47/47
D194,611	S	*	2/1963	Faulkner	D22/147
D198,824	S	*	8/1964	Murphy	D8/1
D222,672	S	*	11/1971	Sather	D22/148
D239,820	S	*	5/1976	Retrum	D8/1
4,745,706	A	*	5/1988	Maza et al.	47/47

D331,526	S	*	12/1992	Miller	D8/1
D370,049	S	*	5/1996	Acker	D22/148
D376,300	S	*	12/1996	Brown et al.	D8/1
5,711,107	A	*	1/1998	Louisiana	47/45
D390,429	S	*	2/1998	Spero	D8/1
D403,560	S	*	1/1999	Ruggiero	D8/1

* cited by examiner

Primary Examiner—Doris V. Coles

Assistant Examiner—Mimosa De

(74) *Attorney, Agent, or Firm*—Sperry, Zoda & Kane

(57) **CLAIM**

The ornamental design for a transparent plant stake with transparent tie member, as shown.

DESCRIPTION

FIG. 1 is a perspective view of a transparent plant stake with transparent tie member showing our new design;

FIG. 2 is a top plan view of the embodiment shown in FIG. 1;

FIG. 3 is a side elevational view of the embodiment shown in FIG. 1;

FIG. 4 is an end elevational view of the embodiment shown in FIG. 1;

FIG. 5 is a bottom plan view of the embodiment shown in FIG. 1; and,

FIG. 6 is a perspective illustration of the tie member shown in the unsecured position.

The broken line showing of the plant in FIGS. 1 through 5 is for illustrative purposes only and forms no part of the claimed design. The breaks are shown in FIGS. 1, 3, and 4 to indicate of indeterminate length.

1 Claim, 1 Drawing Sheet

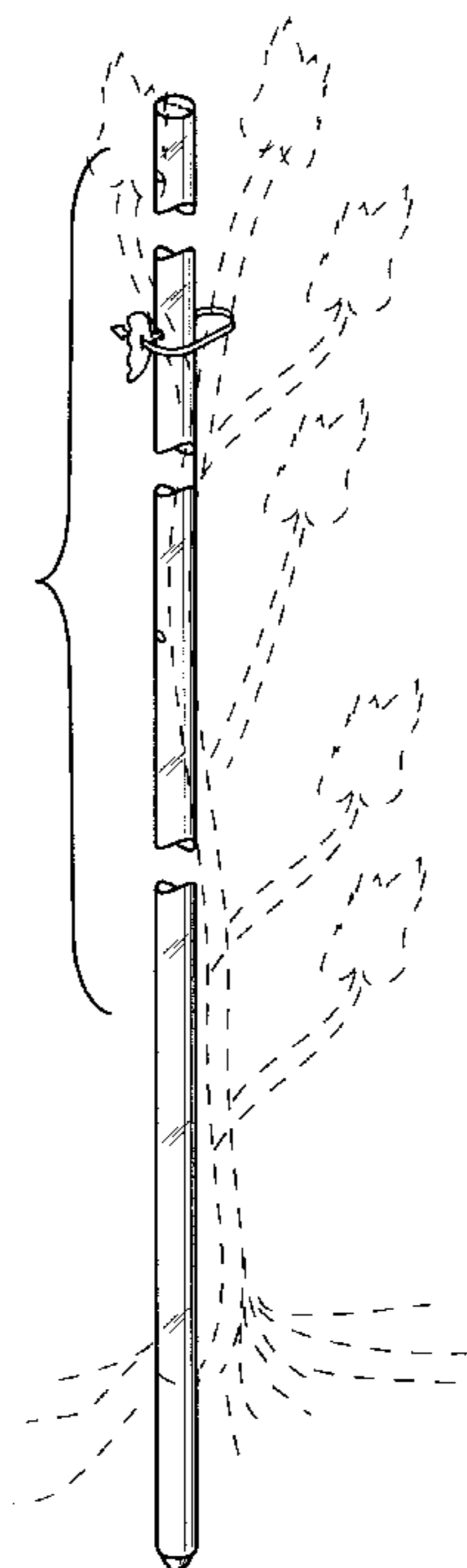

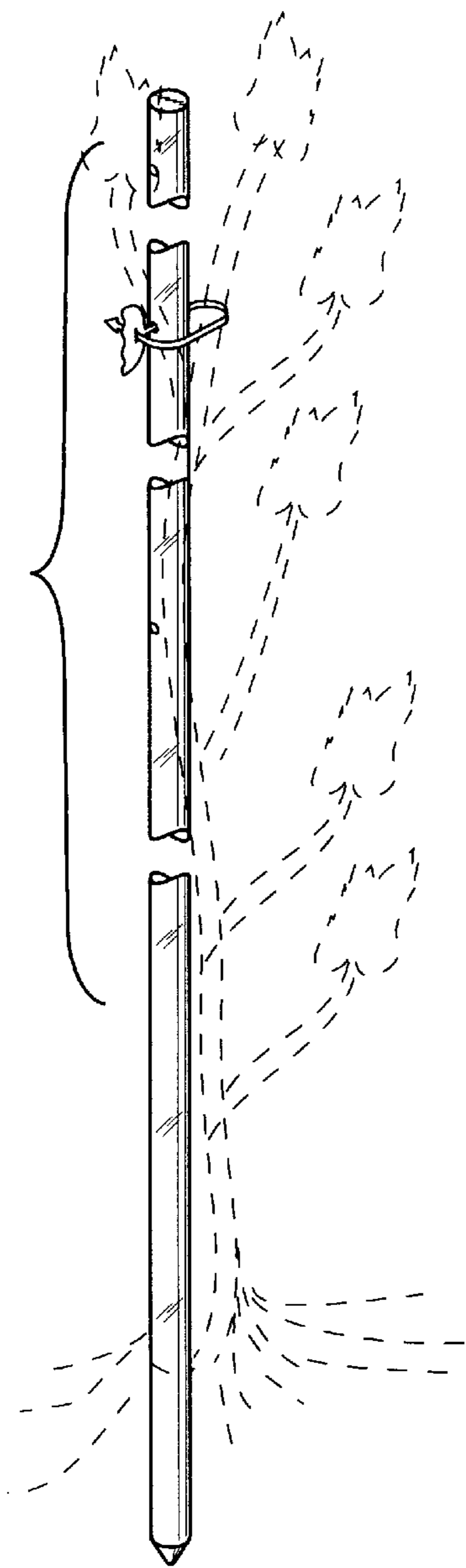

FIG. 1

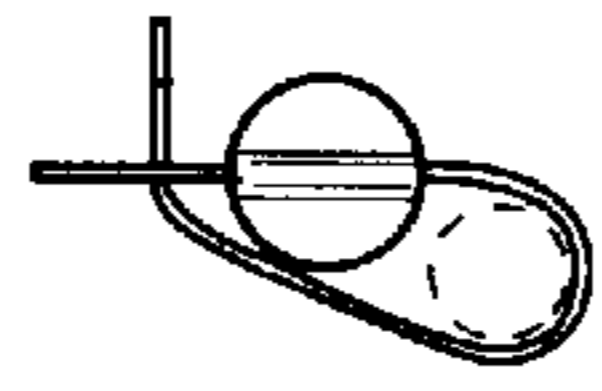

FIG. 2

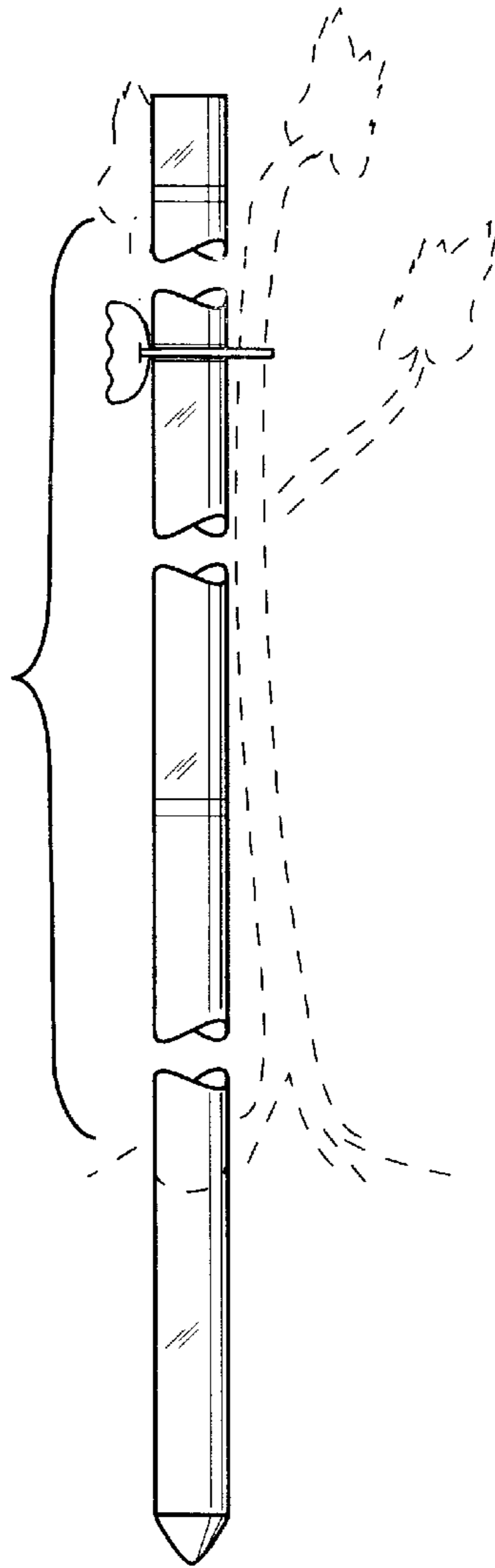

FIG. 3

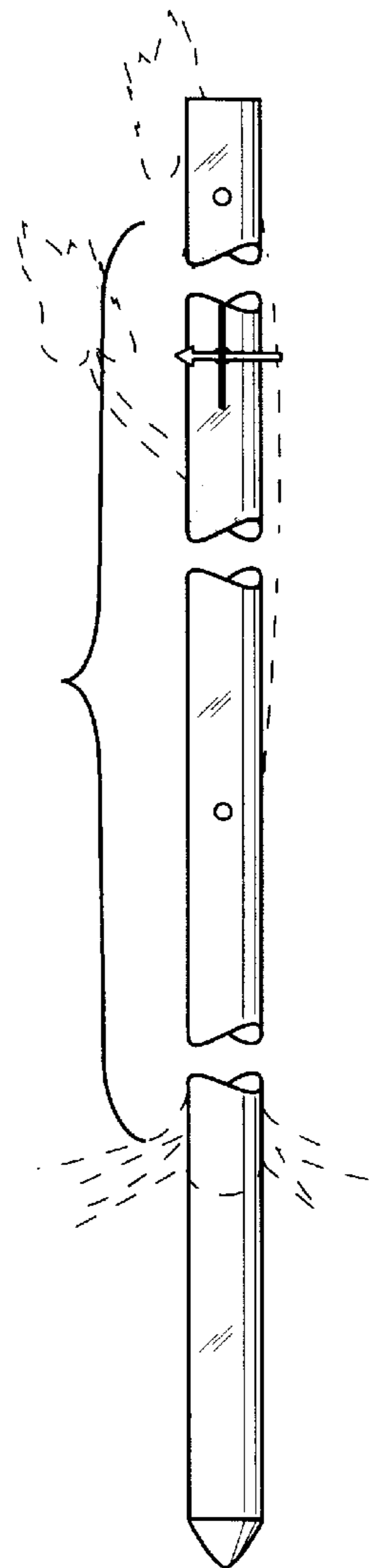

FIG. 4

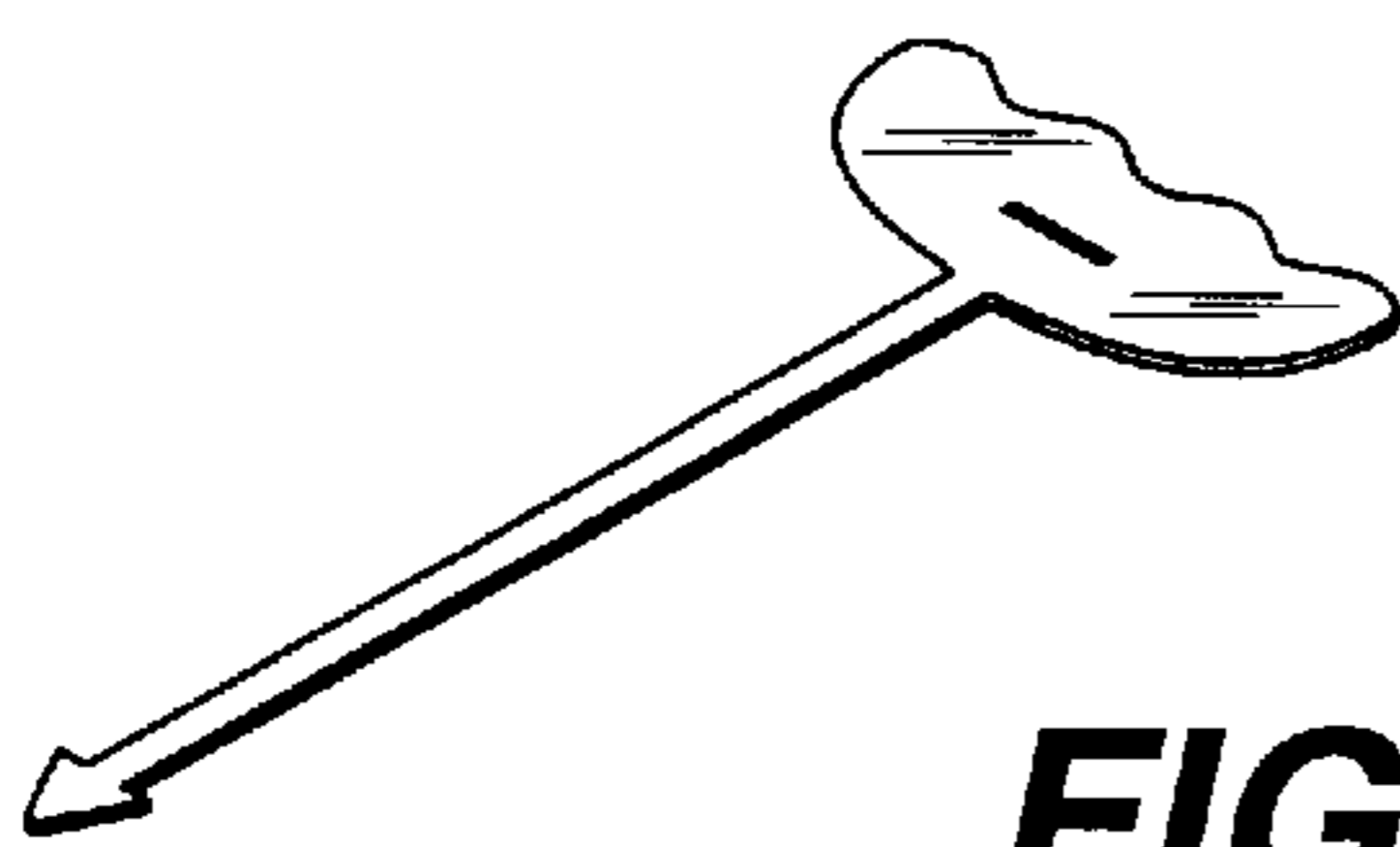

FIG. 6

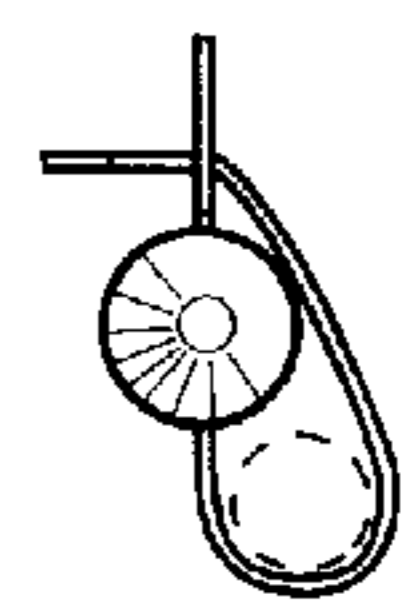

FIG. 5