



US00D466329S

(12) **United States Design Patent**  
**Risdon**

(10) **Patent No.:** **US D466,329 S**

(45) **Date of Patent:** **\*\* Dec. 3, 2002**

(54) **BED**

(75) Inventor: **Scott M. Risdon**, Greensboro, NC (US)

(73) Assignee: **Vaughan Furniture Industries, Incorporated**, Galax, VA (US)

(\*\*) Term: **14 Years**

(21) Appl. No.: **29/149,689**

(22) Filed: **Oct. 15, 2001**

(51) **LOC (7) Cl.** ..... **06-01**

(52) **U.S. Cl.** ..... **D6/393**

(58) **Field of Search** ..... D6/382, 389, 392-395,  
D6/505-508; 5/53.1, 279.1, 280, 281, 907

(56) **References Cited**

**U.S. PATENT DOCUMENTS**

D282,231 S	1/1986	Scully	.....	D6/506
D443,433 S	* 6/2001	McDaniel et al.	.....	D6/393
D449,939 S	* 11/2001	Vaaler	.....	D6/393
D450,198 S	* 11/2001	McDaniel et al.	.....	D6/393

**OTHER PUBLICATIONS**

Burlington, Stone Gate, c1983, headboard.\*  
Burlington c1984, Campella, p. 3, headbaord at left.\*

\* cited by examiner

*Primary Examiner*—Janice E. Seeger

(74) *Attorney, Agent, or Firm*—Womble Carlyle Sandridge & Rice, PLLC; C. Robert Rhodes

(57) **CLAIM**

The ornamental design for a bed, as shown and described.

**DESCRIPTION**

FIG. 1 is a front left perspective view of a bed showing my new design;  
 FIG. 2 is a front perspective thereof;  
 FIG. 3 is a side view of the headboard of the embodiment of FIG. 1;  
 FIG. 4 is a side view of the footboard of the embodiment of FIG. 1;  
 FIG. 5 is a left front perspective view of the headboard;  
 FIG. 6 is a front view of the headboard illustrating the decorative central top molding configuration;  
 FIG. 7 is a left front perspective view of the footboard of the embodiment of FIG. 1;  
 FIG. 8 is a front view of the footboard of the embodiment of FIG. 1;  
 FIG. 9 is an enlarged left front perspective view of the decorative ornamentation atop the center of the headboard; and,  
 FIG. 10 is an enlarged front perspective view of the upper left corner portion of the headboard illustrating a finial and surface configuration.  
 The broken lines are for environmental purposes only and form no part of the claimed design.

**1 Claim, 9 Drawing Sheets**

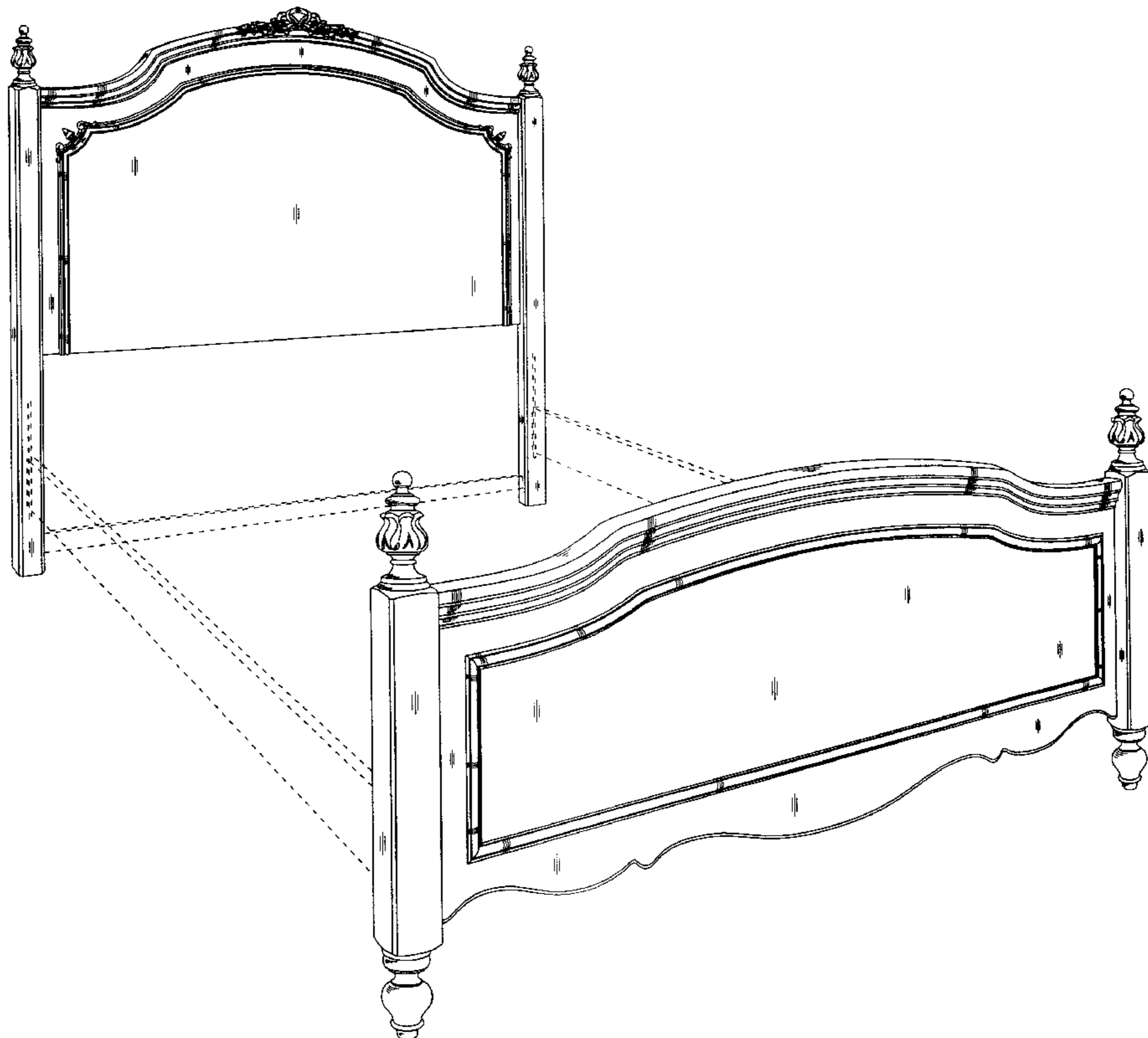

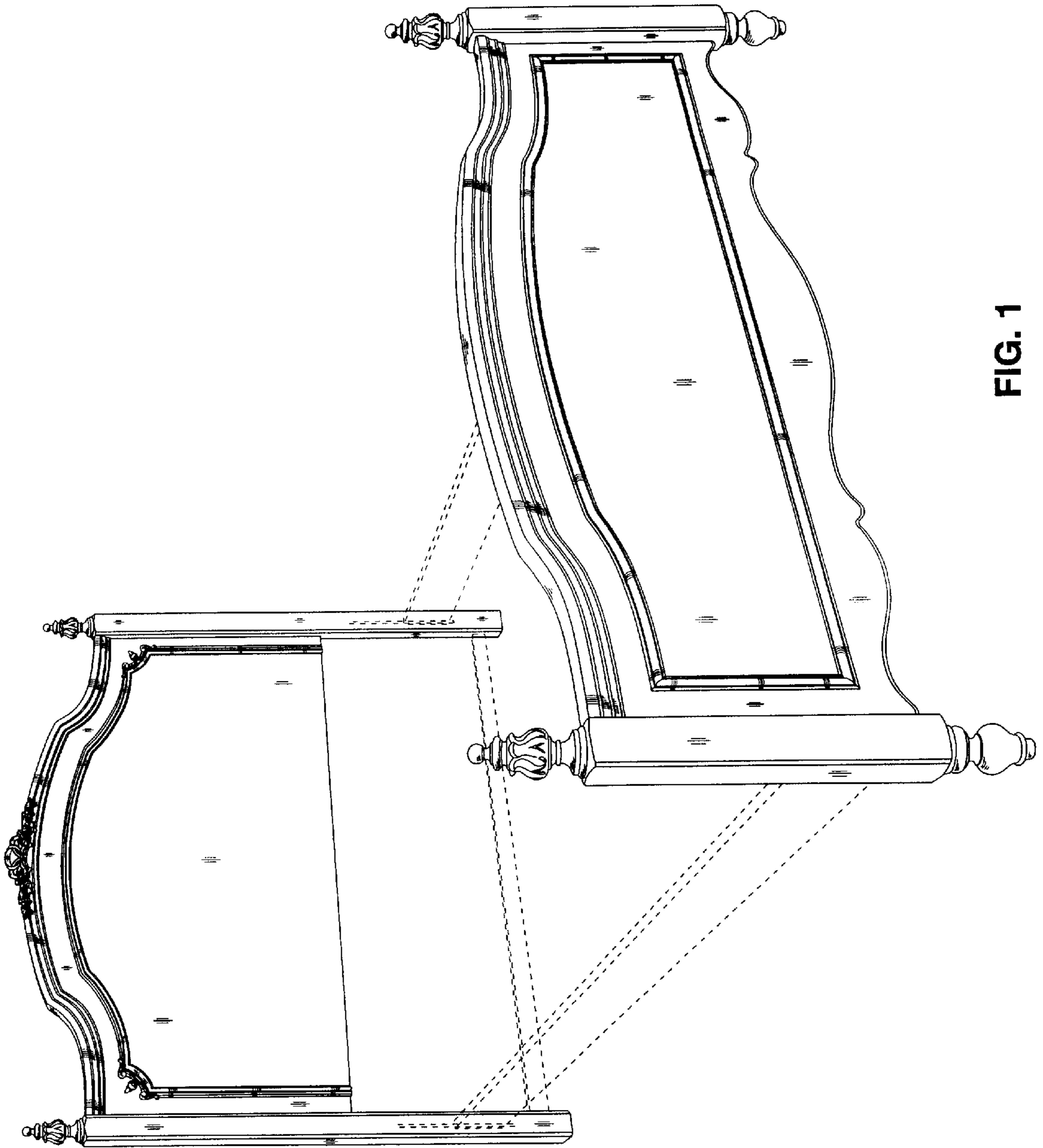

FIG. 1

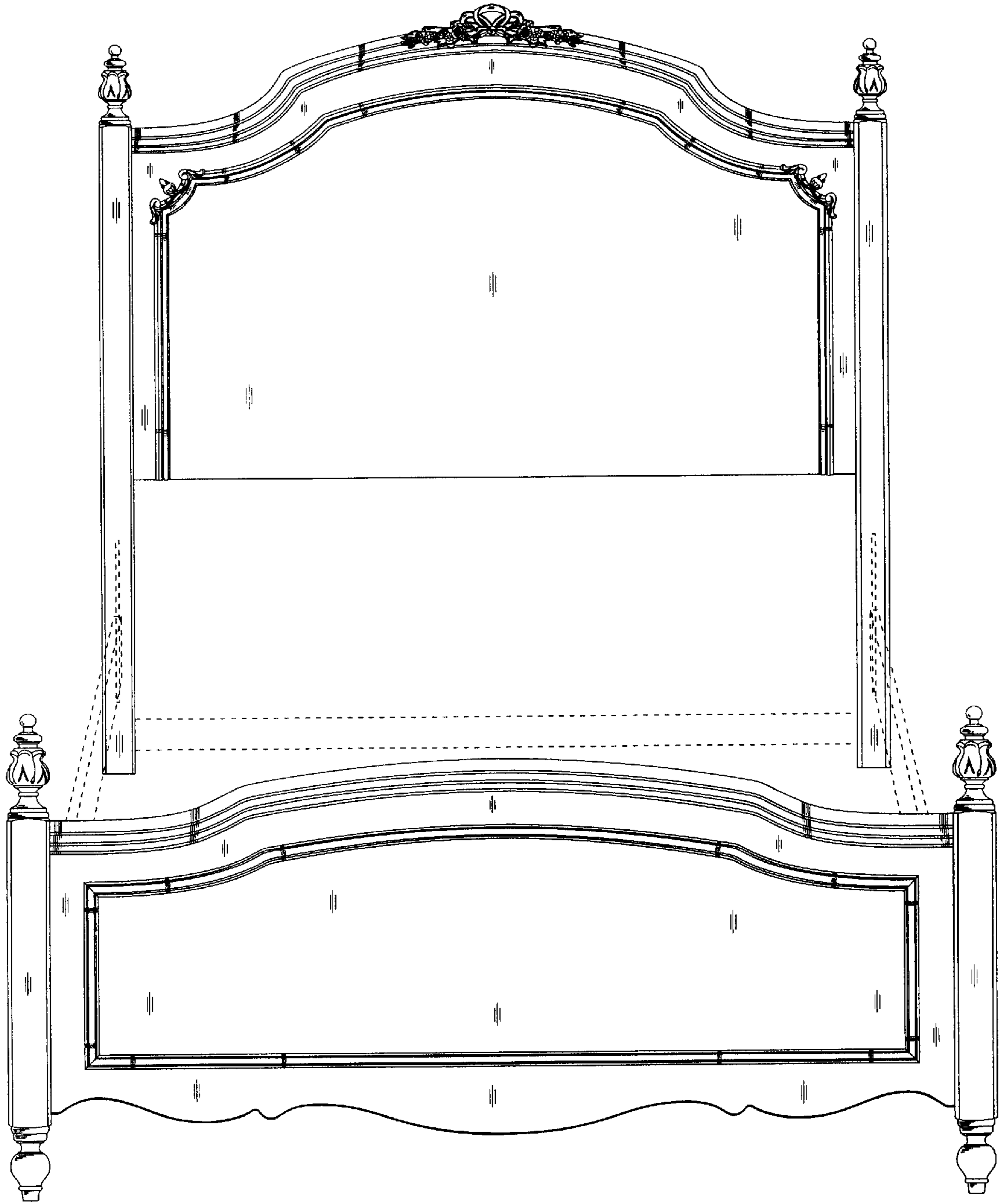

FIG. 2

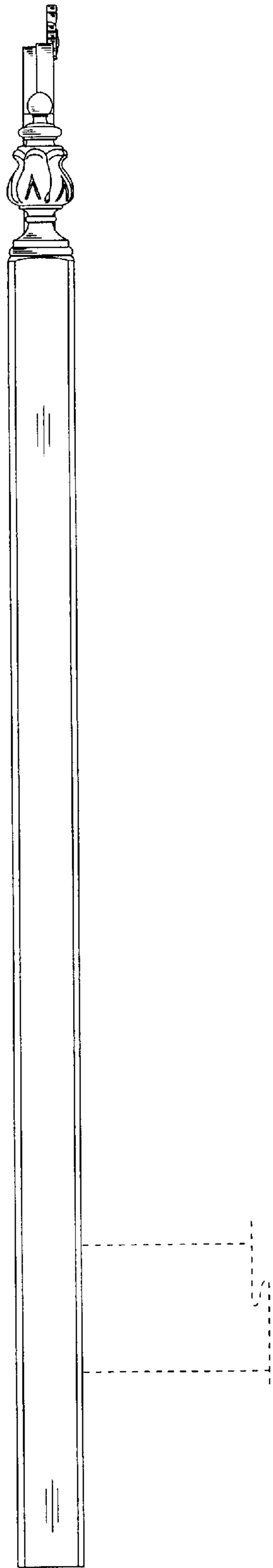

FIG. 3

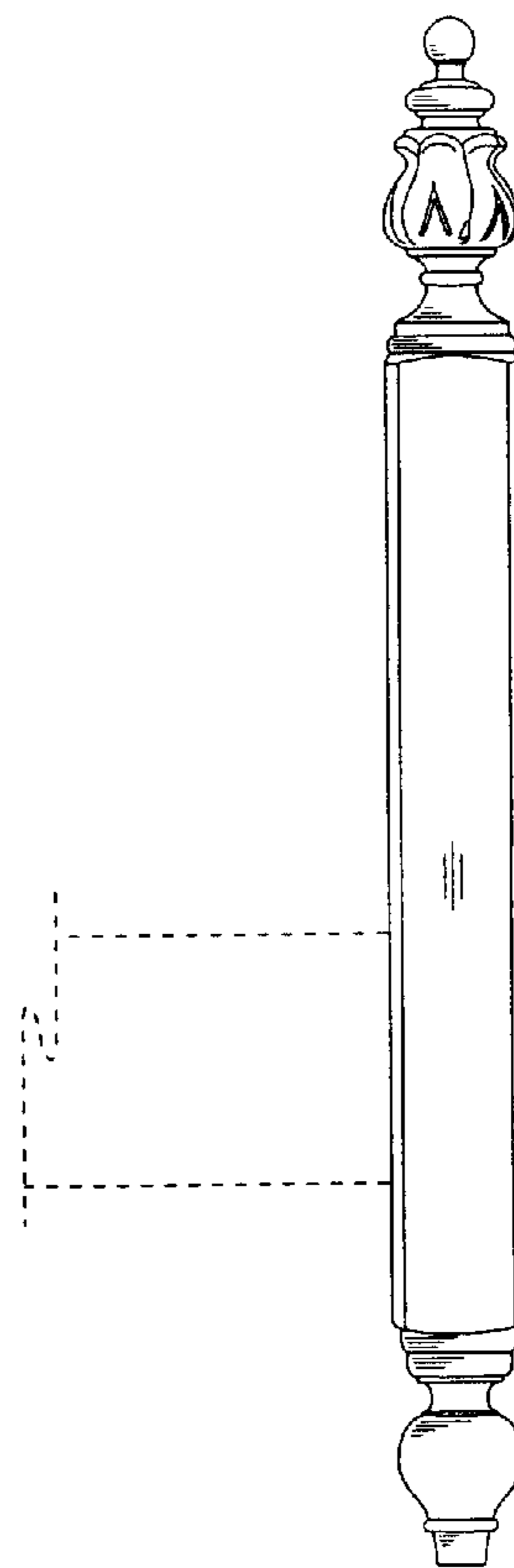

FIG. 4

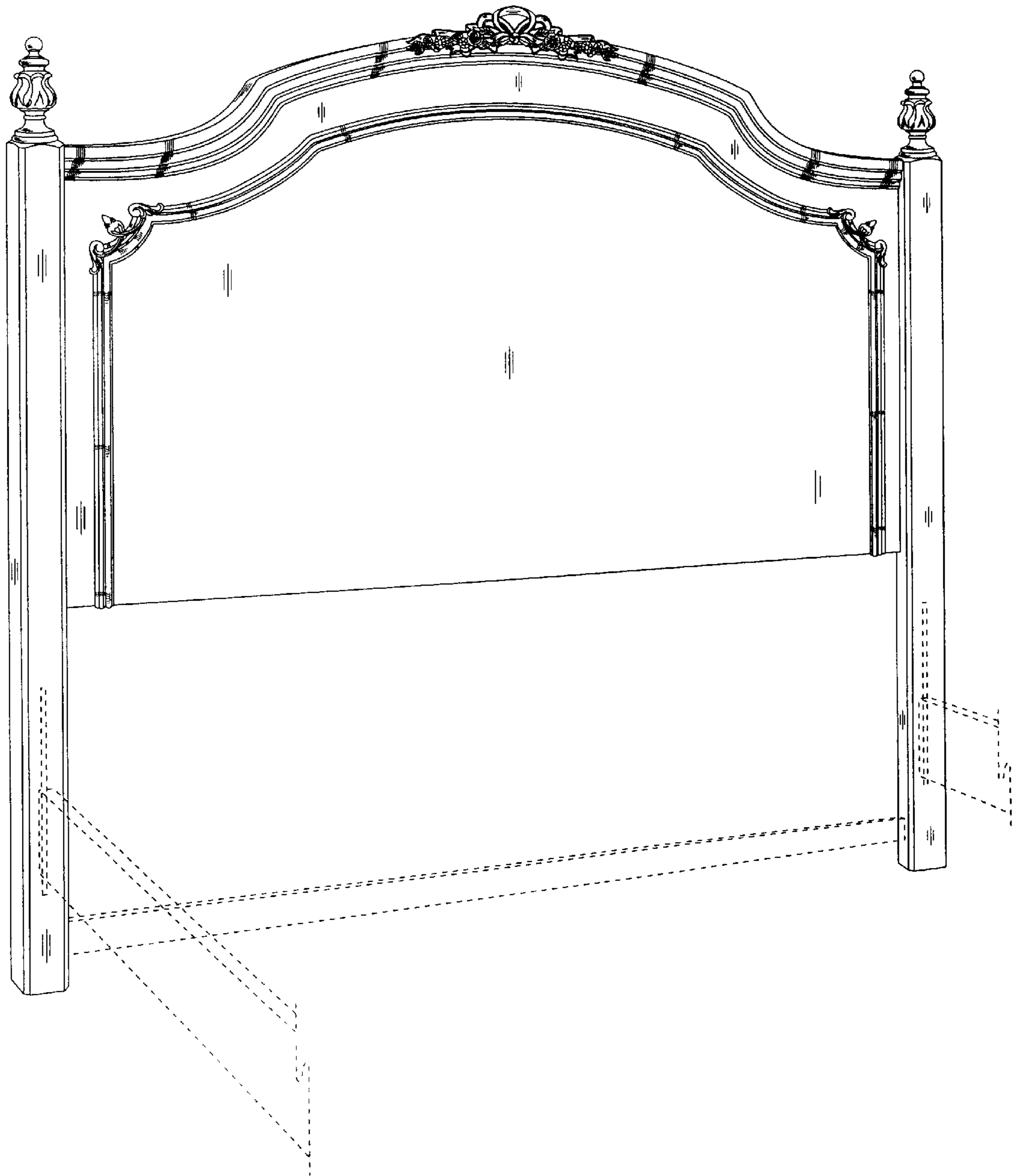

FIG. 5

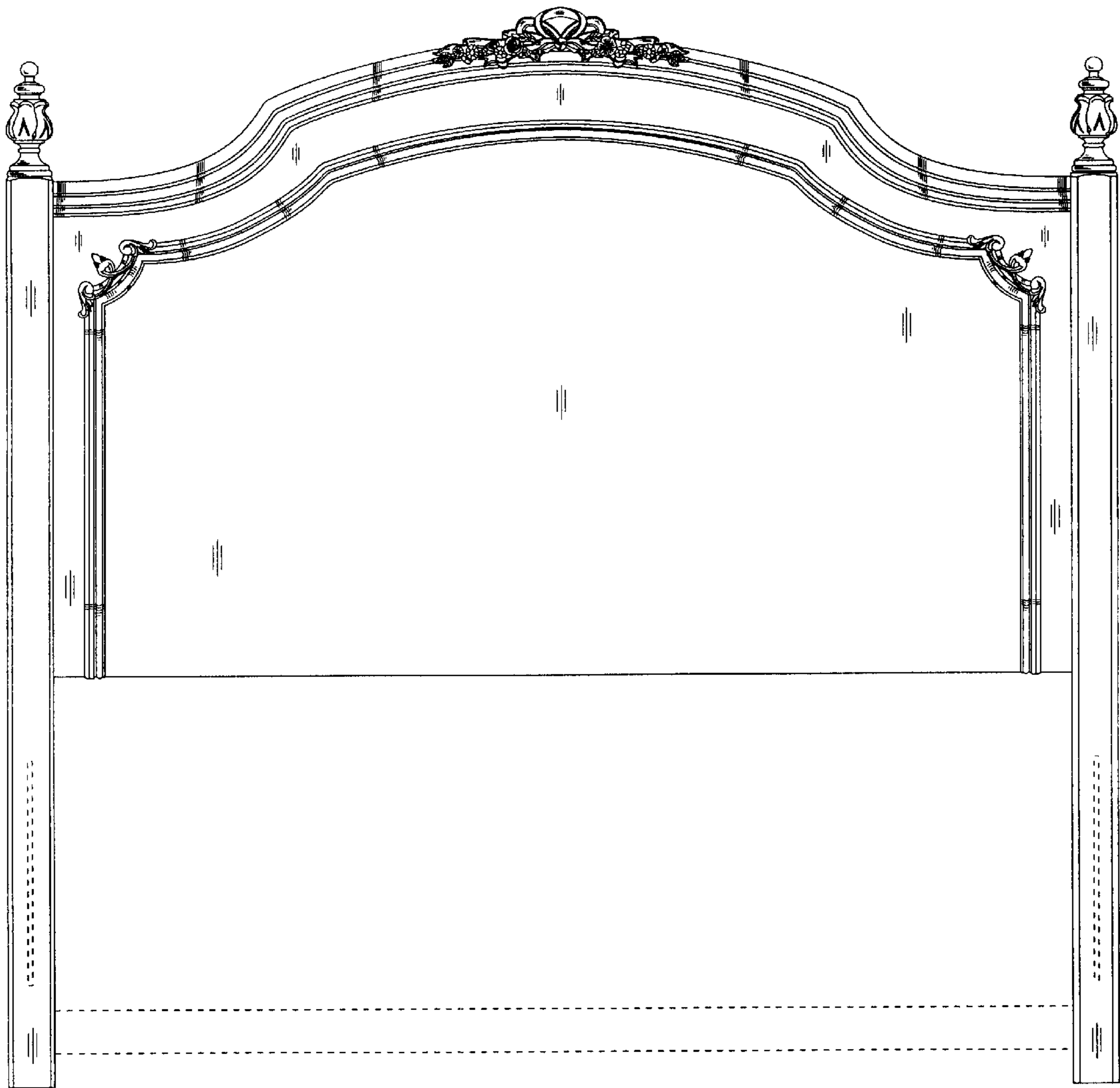

FIG. 6

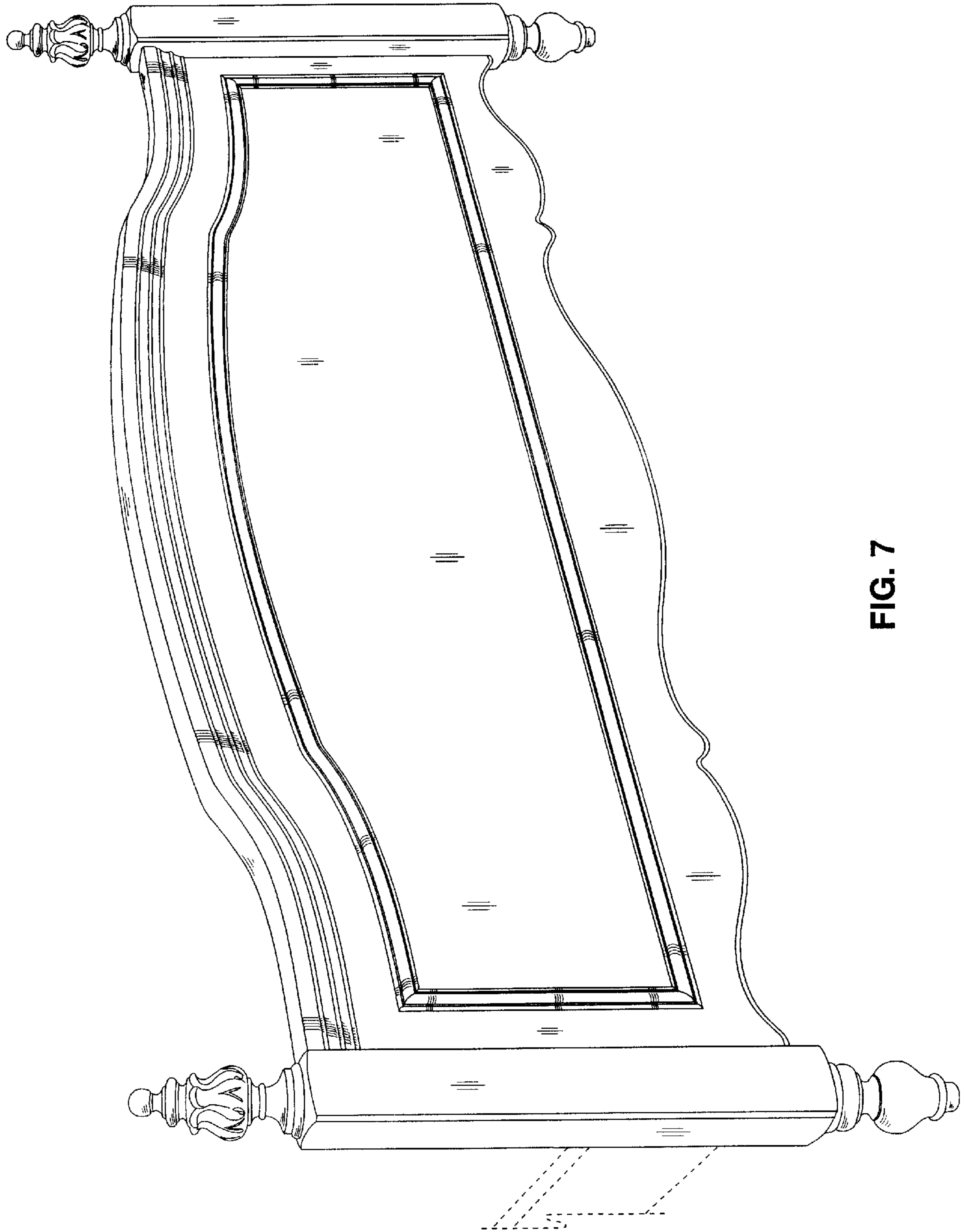

FIG. 7

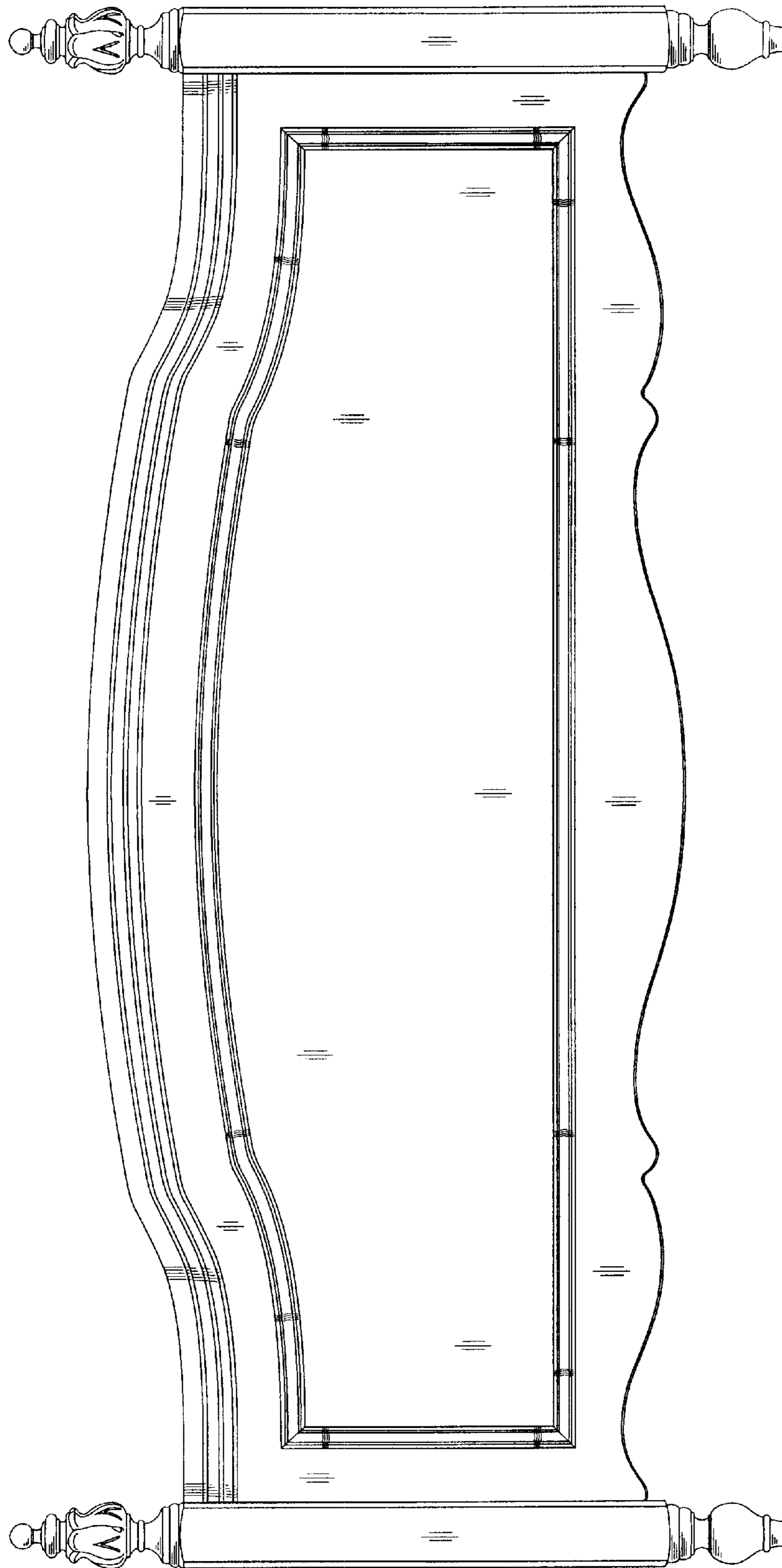
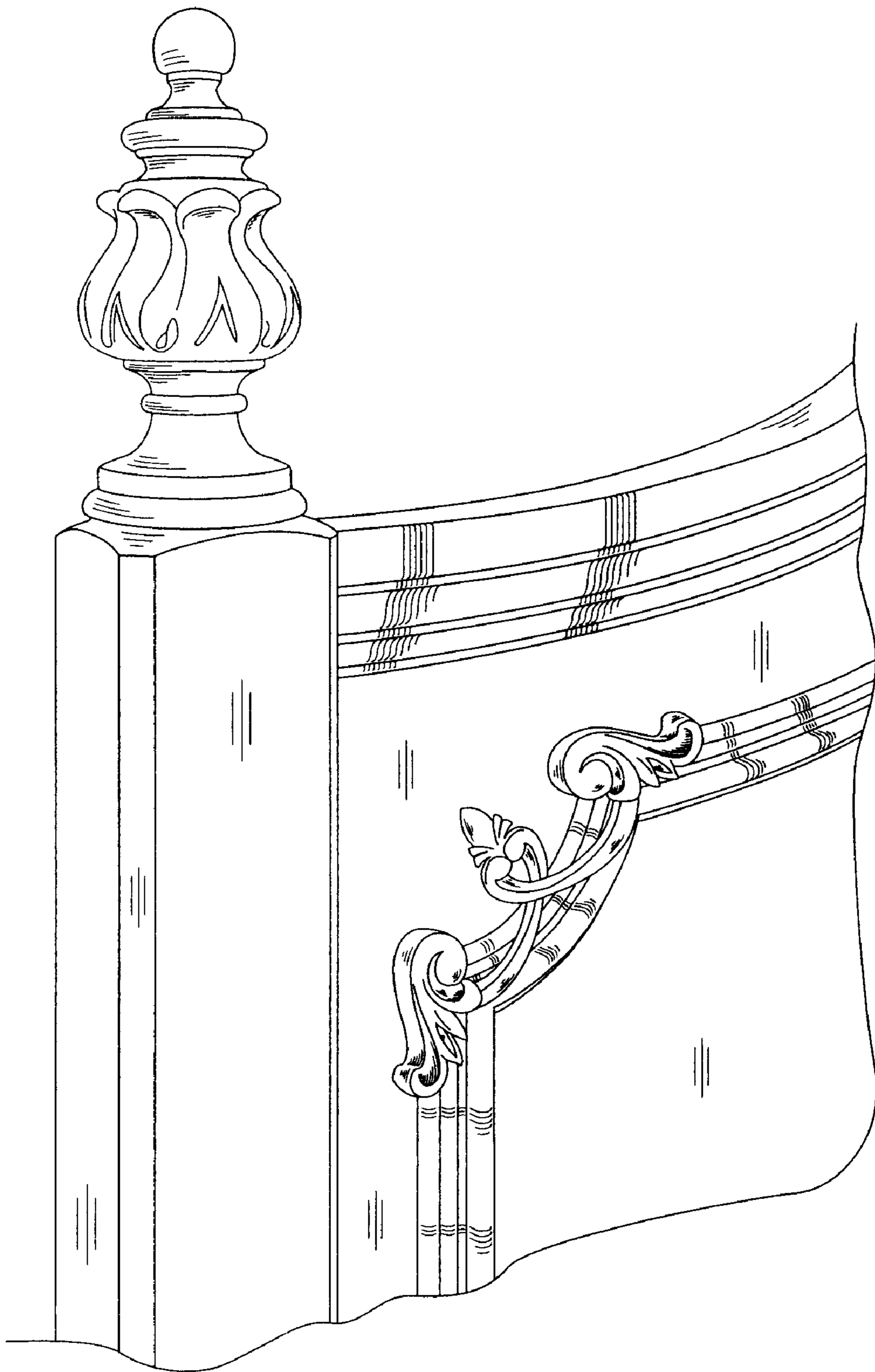

FIG. 8





FIG. 9



**FIG. 10**