



US00D466193S

(12) **United States Design Patent**
Otero et al.

(10) **Patent No.:** **US D466,193 S**

(45) **Date of Patent:** **** Nov. 26, 2002**

(54) **FAUCET**

(75) **Inventors:** **Federico G. Otero**, Carmel, IN (US);
Anthony G. Spangler, Greensburg, IN (US)

(73) **Assignee:** **Masco Corporation of Indiana**,
Indianapolis, IN (US)

(**) **Term:** **14 Years**

(21) **Appl. No.:** **29/152,008**

(22) **Filed:** **Dec. 12, 2001**

(51) **LOC (7) Cl.** **23-01**

(52) **U.S. Cl.** **D23/242; D23/241; D23/238**

(58) **Field of Search** **D23/238-257;**
4/675-678; 137/801

(56) **References Cited**

U.S. PATENT DOCUMENTS

D267,110 S	*	11/1982	Arnolds	D23/242
D293,362 S		12/1987	Hill et al.		
D300,653 S	*	4/1989	Paul	D23/255
D318,906 S		8/1991	Spangler		
D321,750 S		11/1991	Spangler		
D356,631 S	*	3/1995	Kolada	D23/255
D397,207 S		8/1998	Lord		
D399,925 S		10/1998	Lord		
D405,160 S		2/1999	Lord		
D405,869 S		2/1999	Lord		
D406,318 S		3/1999	Lord		
D410,528 S		6/1999	Lord		
D416,982 S	*	11/1999	Warshawsky et al.	D23/241
D428,973 S		8/2000	Spangler		
D428,974 S		8/2000	Spangler		
D429,318 S		8/2000	Spangler		
D429,799 S		8/2000	Spangler		
D429,800 S		8/2000	Spangler		

D430,270 S		8/2000	Lord		
D431,281 S		9/2000	Lord		
D439,953 S	*	4/2001	Lord	D23/241
D448,453 S	*	9/2001	Lord	D23/241

OTHER PUBLICATIONS

U.S. patent application Ser. No. 29/152,002, filed Dec. 12, 2001.

U.S. patent application Ser. No. 29/151,955, filed Dec. 12, 2001.

U.S. patent application Ser. No. 29/152,007, filed Dec. 12, 2001.

* cited by examiner

Primary Examiner—Louis S. Zarfes

Assistant Examiner—Gregory Andoll

(74) *Attorney, Agent, or Firm*—Myron B. Kapustij; Lloyd D. Doigan

(57) **CLAIM**

The ornamental design for a faucet, as shown and described.

DESCRIPTION

FIG. 1 is a front perspective view of the faucet showing our new design;

FIG. 2 is a rear perspective view thereof;

FIG. 3 is a right side elevational view thereof;

FIG. 4 is a left side elevational view thereof;

FIG. 5 is a front elevational view thereof;

FIG. 6 is a rear elevational view thereof;

FIG. 7 is a top plan view thereof; and,

FIG. 8 is a bottom plan view thereof.

The broken line showing of the handles and lift rod in FIG. 1, and of the waterway in the interior tip of the spout in FIG. 8 are for purposes of illustration only and form no part of the claimed design.

1 Claim, 8 Drawing Sheets

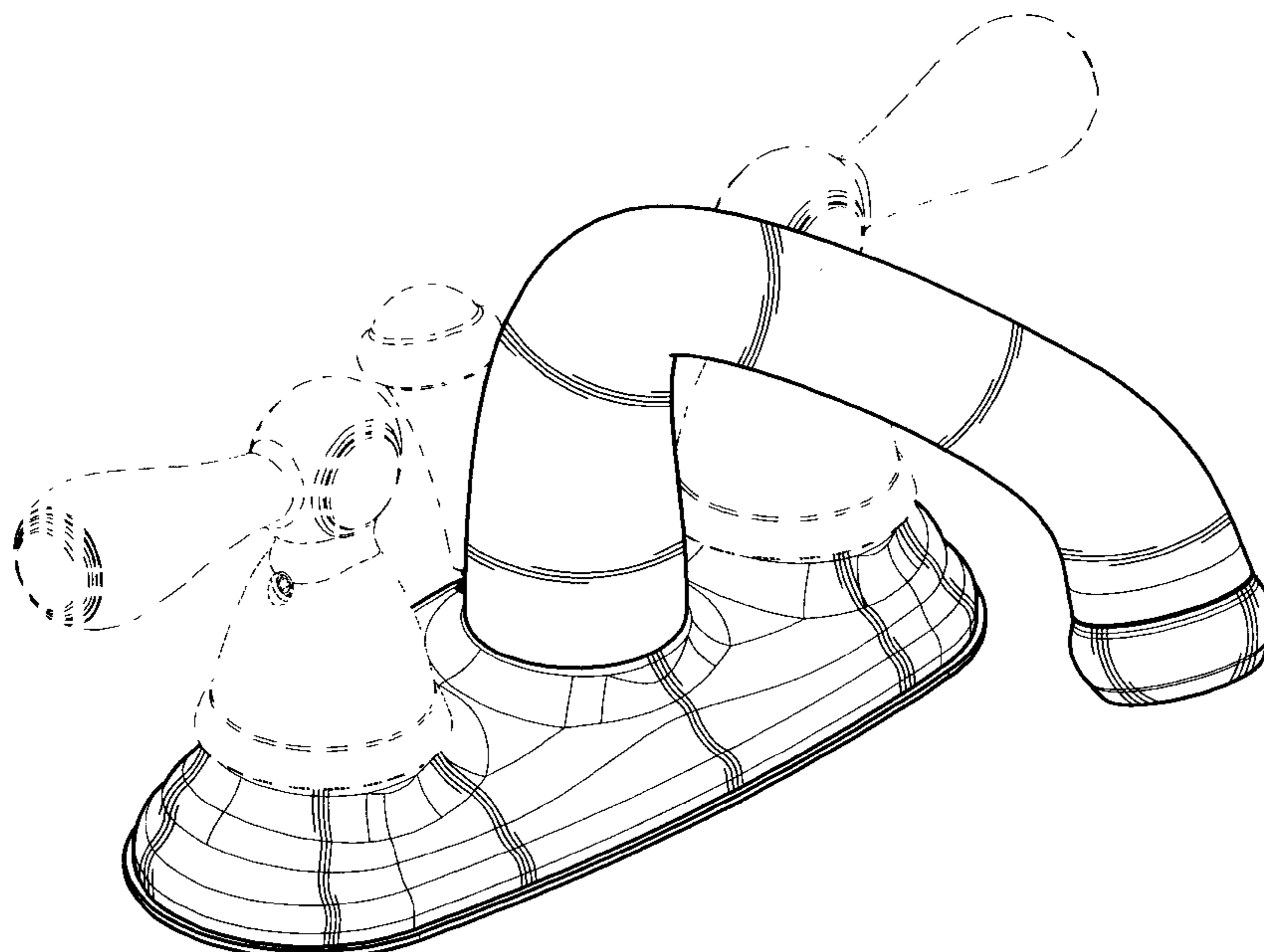

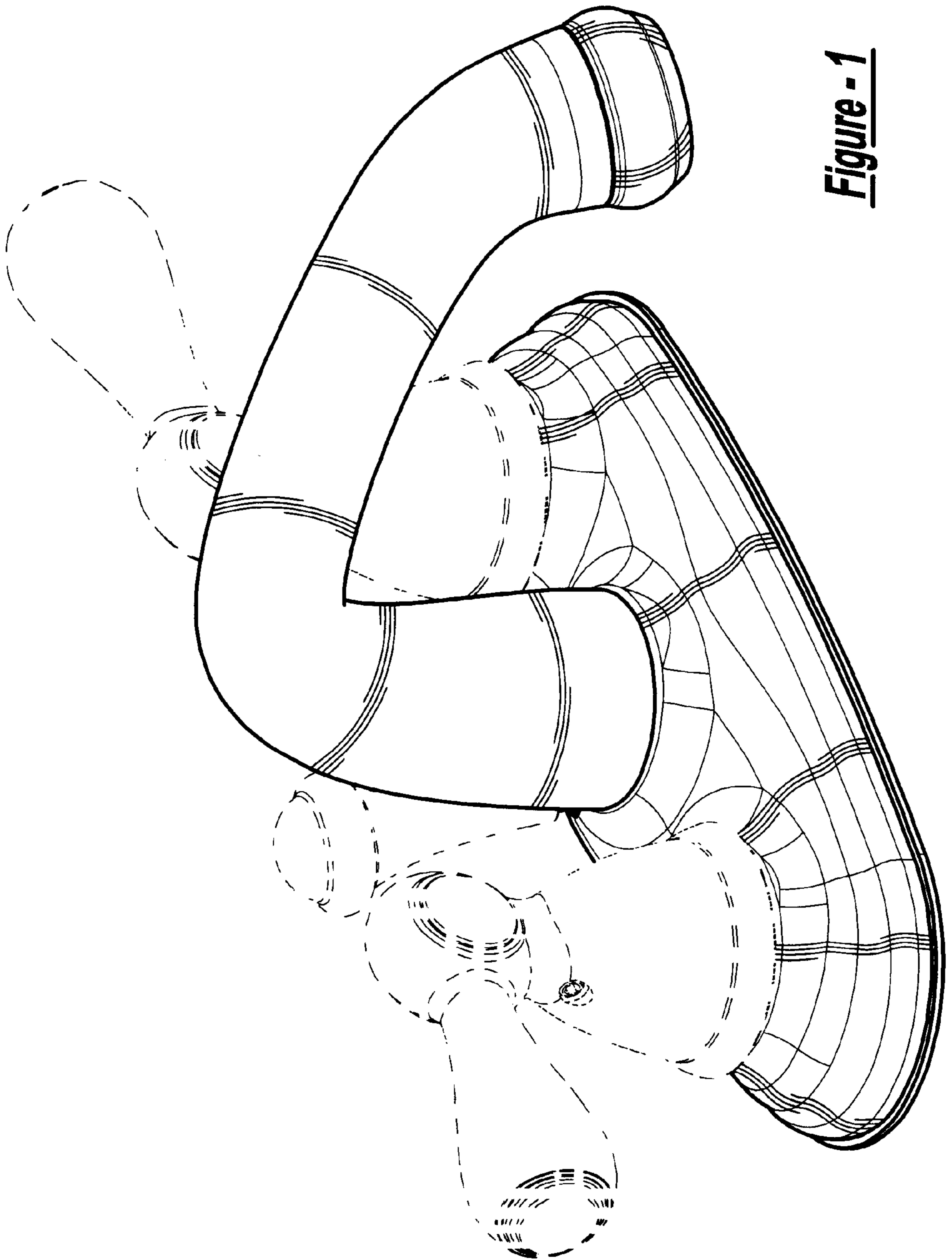

Figure - 1

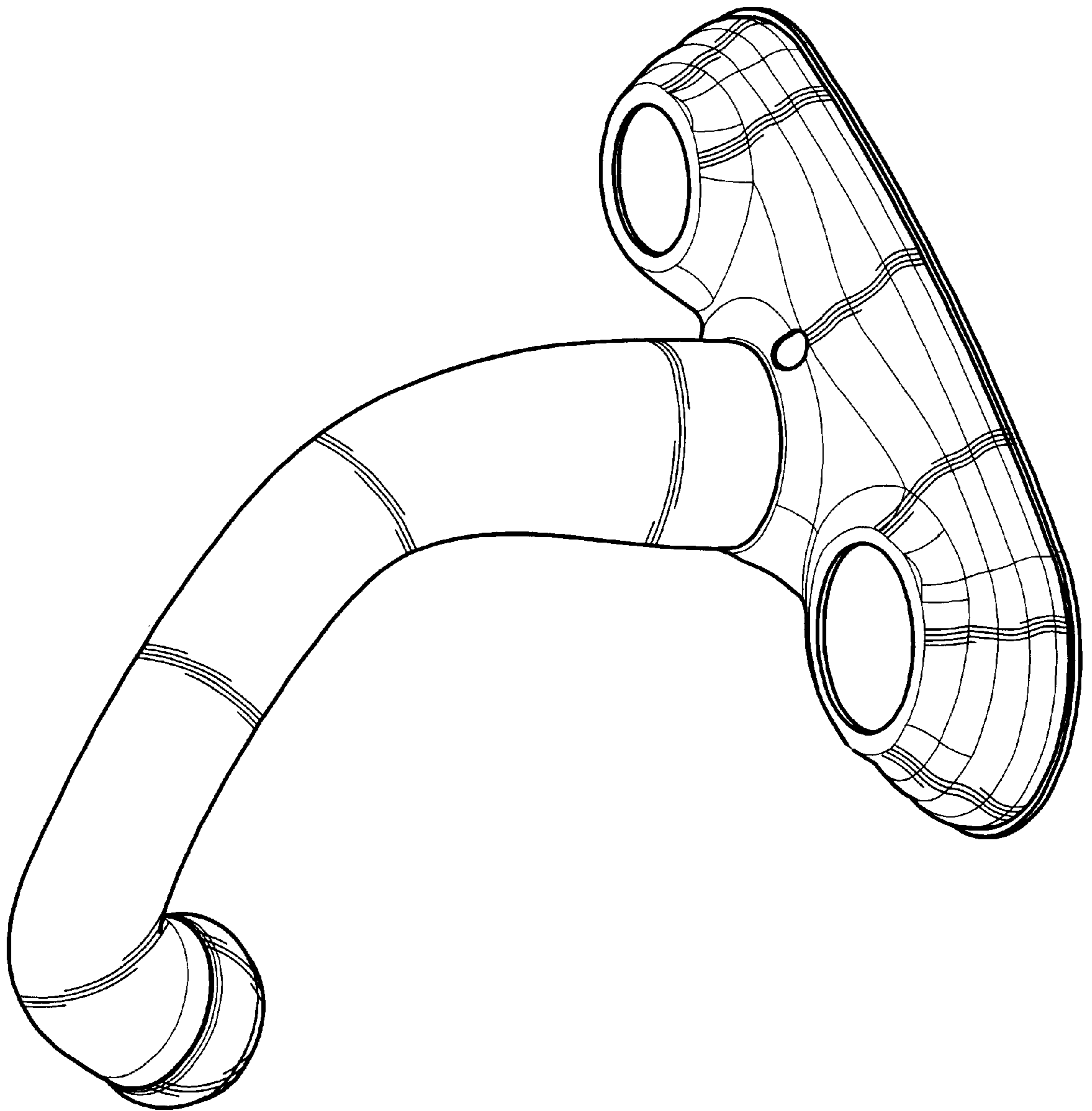

Figure - 2

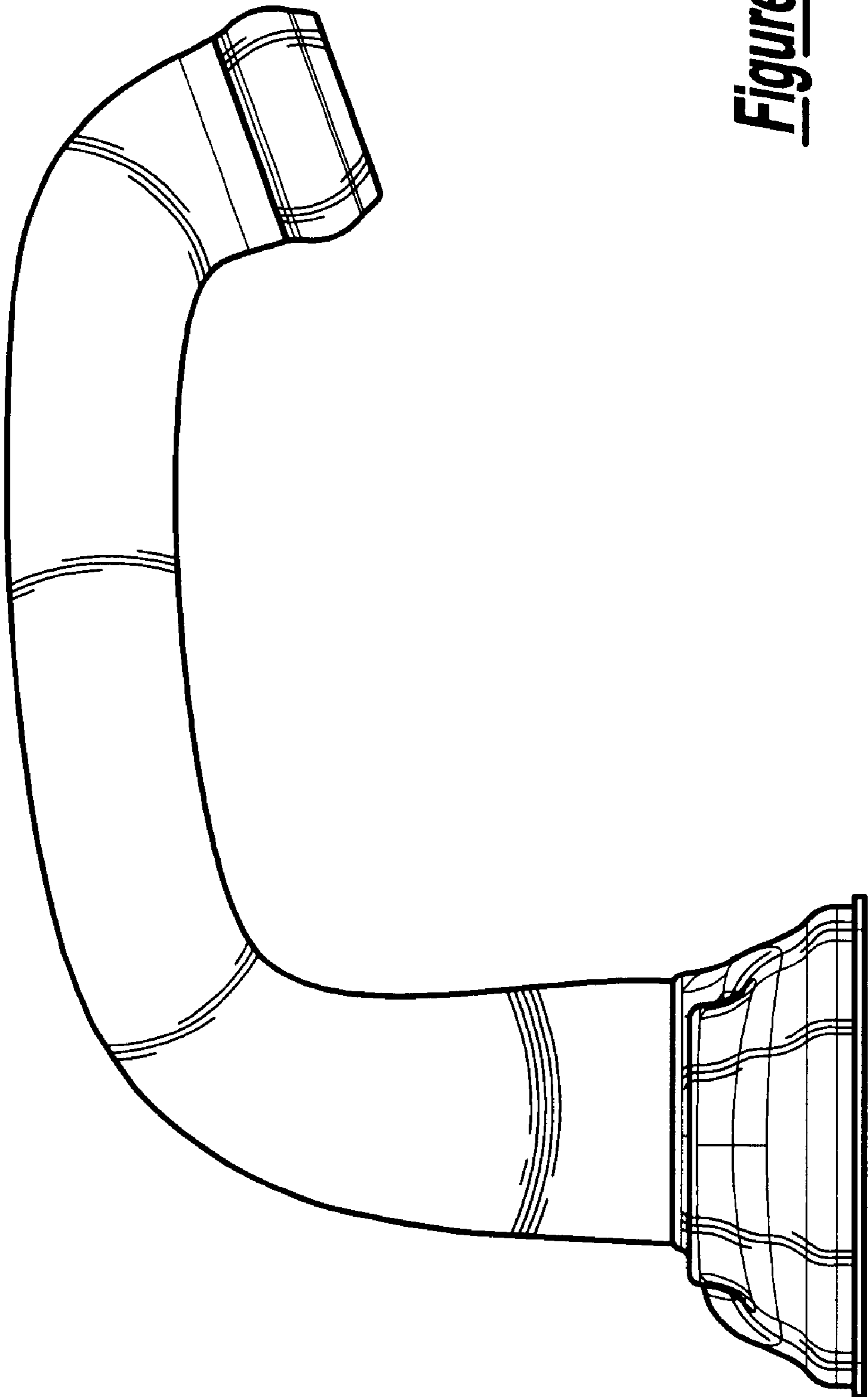

Figure - 3

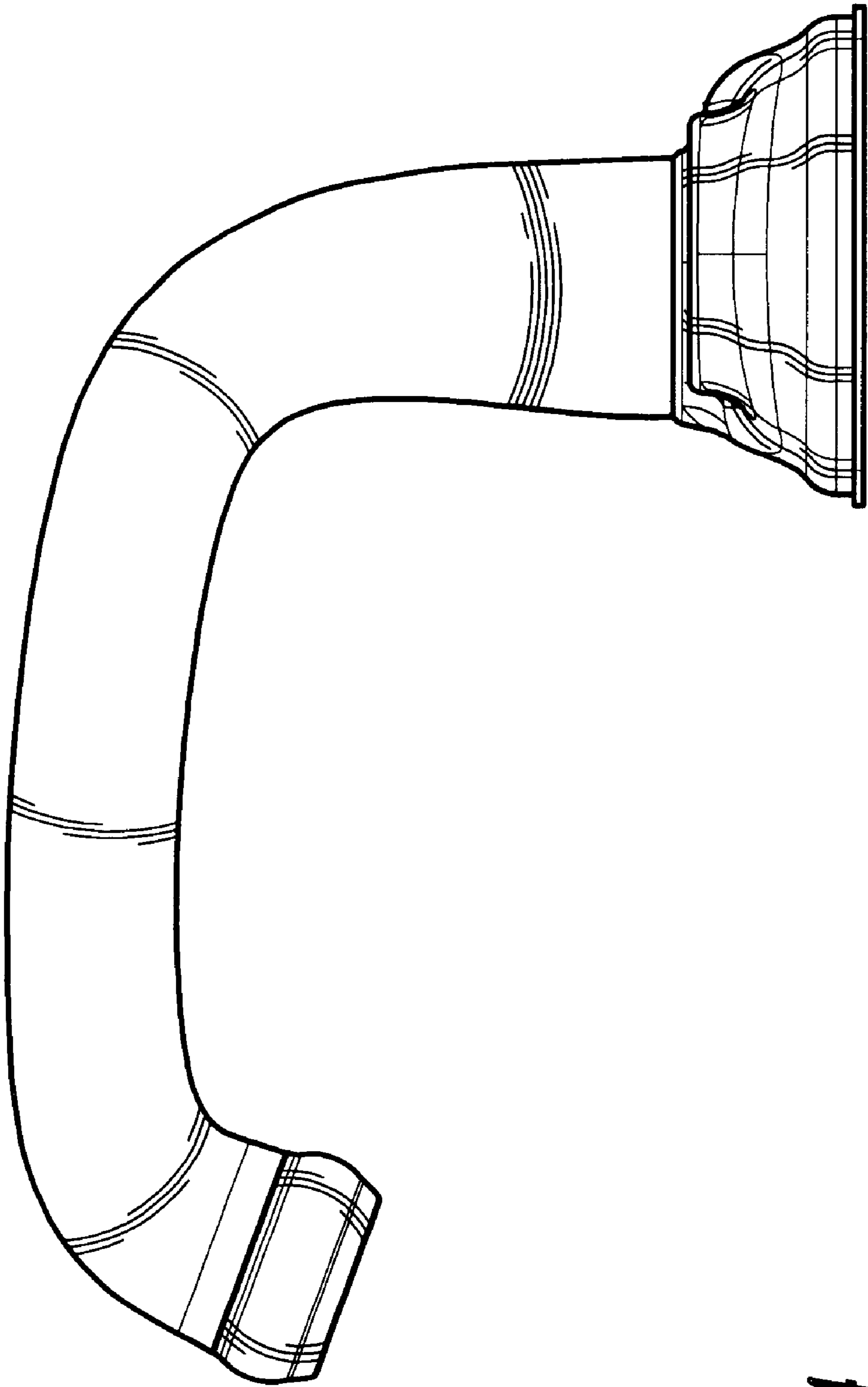

Figure - 4

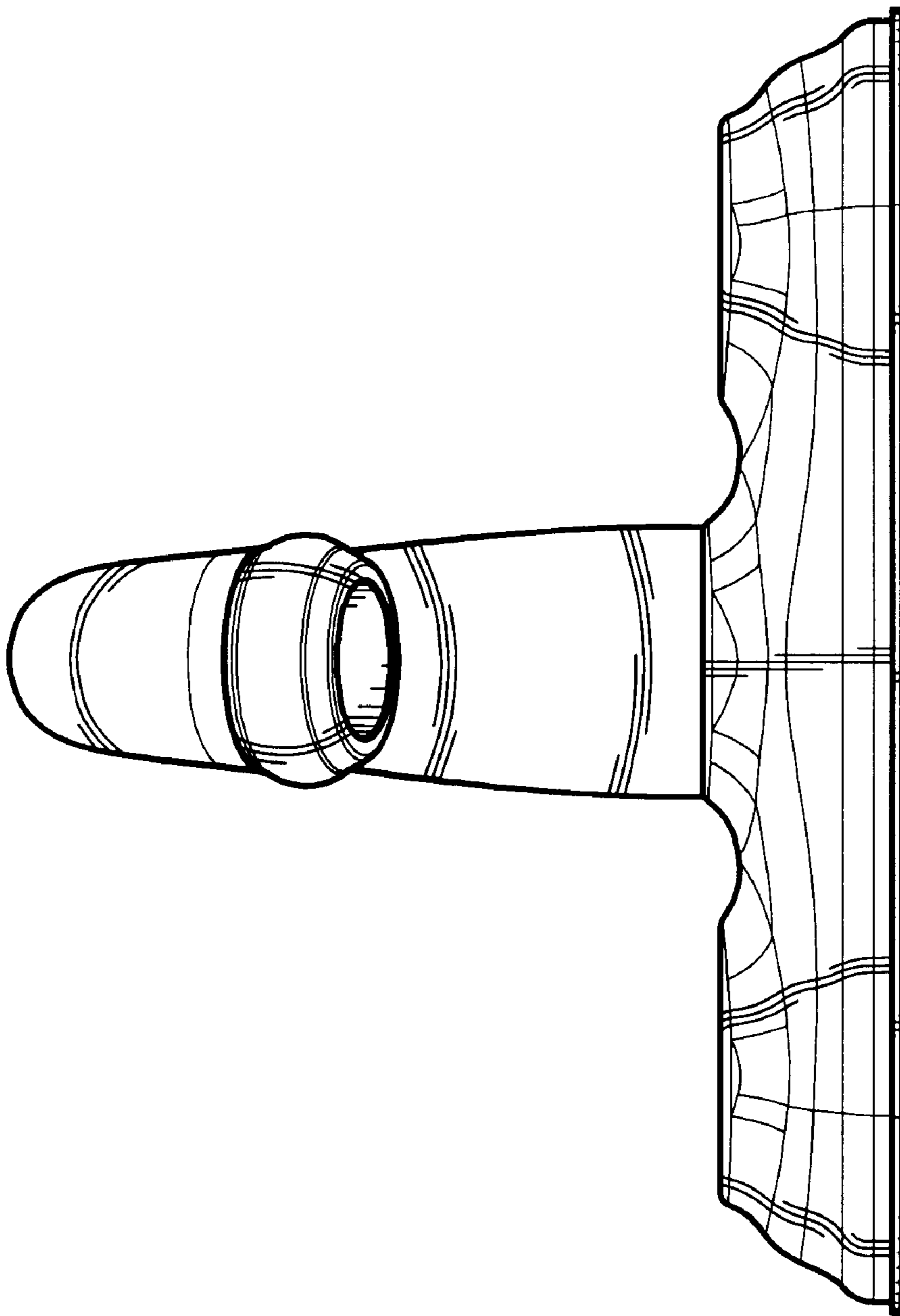

Figure - 5

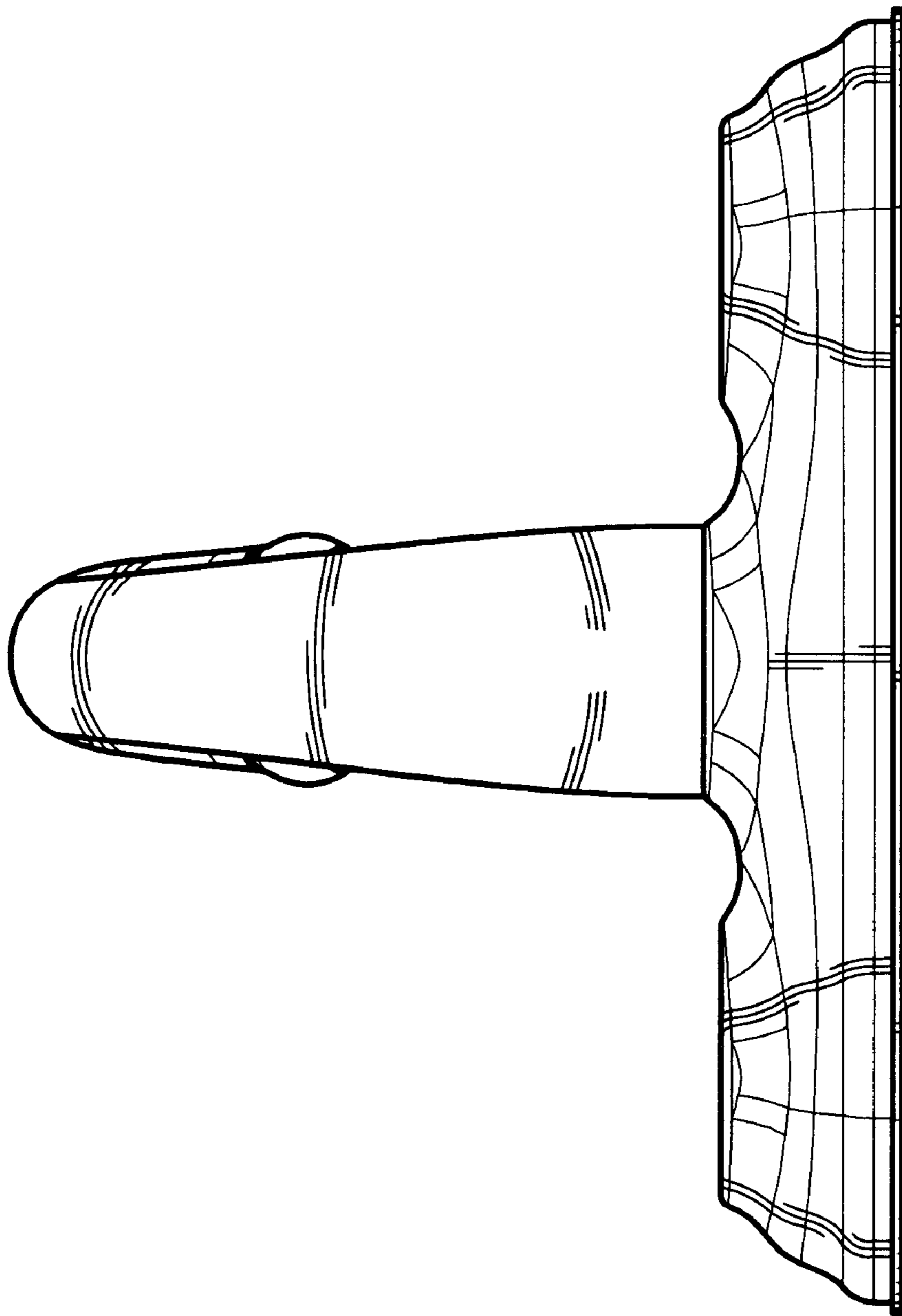

Figure - 6

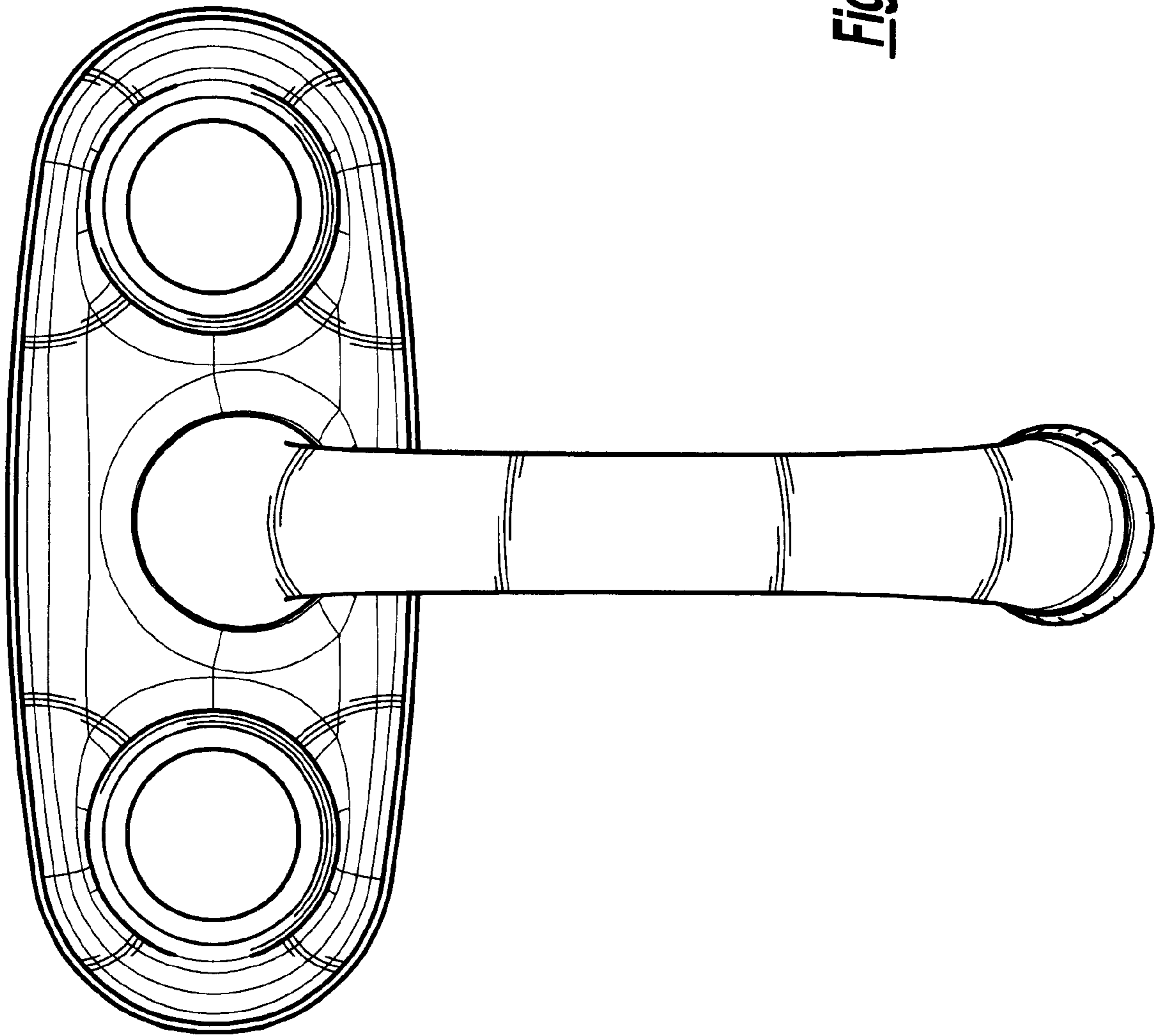

Figure - 7

Figure - 8

