



US00D466186S

(12) **United States Design Patent**
Tse

(10) **Patent No.:** **US D466,186 S**

(45) **Date of Patent:** **** Nov. 26, 2002**

(54) **SHOWERHEAD**

D440,630 S * 4/2001 Gottwald D23/223

(75) Inventor: **Hing Fai Tse**, New Territories (HK)

* cited by examiner

(73) Assignee: **Brand New Technology Ltd.**, Kowloon (HK)

Primary Examiner—Robin V. Taylor

(74) *Attorney, Agent, or Firm*—Leydig, Voit & Mayer, Ltd.

(**) Term: **14 Years**

(57) **CLAIM**

(21) Appl. No.: **29/153,227**

The ornamental design for a showerhead, as shown and described.

(22) Filed: **Jan. 8, 2002**

DESCRIPTION

(51) **LOC (7) Cl.** **23-01**

(52) **U.S. Cl.** **D23/223**

(58) **Field of Search** D23/213, 223,
D23/226, 229, 230; 239/394, 462

FIG. 1 is a right side perspective of a showerhead showing my new design;

FIG. 2 is a front elevational view thereof;

FIG. 3 is a rear elevational view thereof;

FIG. 4 is a right side elevational view thereof;

FIG. 5 is a left side elevational view thereof;

FIG. 6 is a top end elevational view thereof; and,

FIG. 7 is a bottom end elevational view thereof.

(56) **References Cited**

U.S. PATENT DOCUMENTS

D432,625 S * 10/2000 Chan D23/223

D434,468 S * 11/2000 Chan D23/223

D439,306 S * 3/2001 Tse D23/223

1 Claim, 4 Drawing Sheets

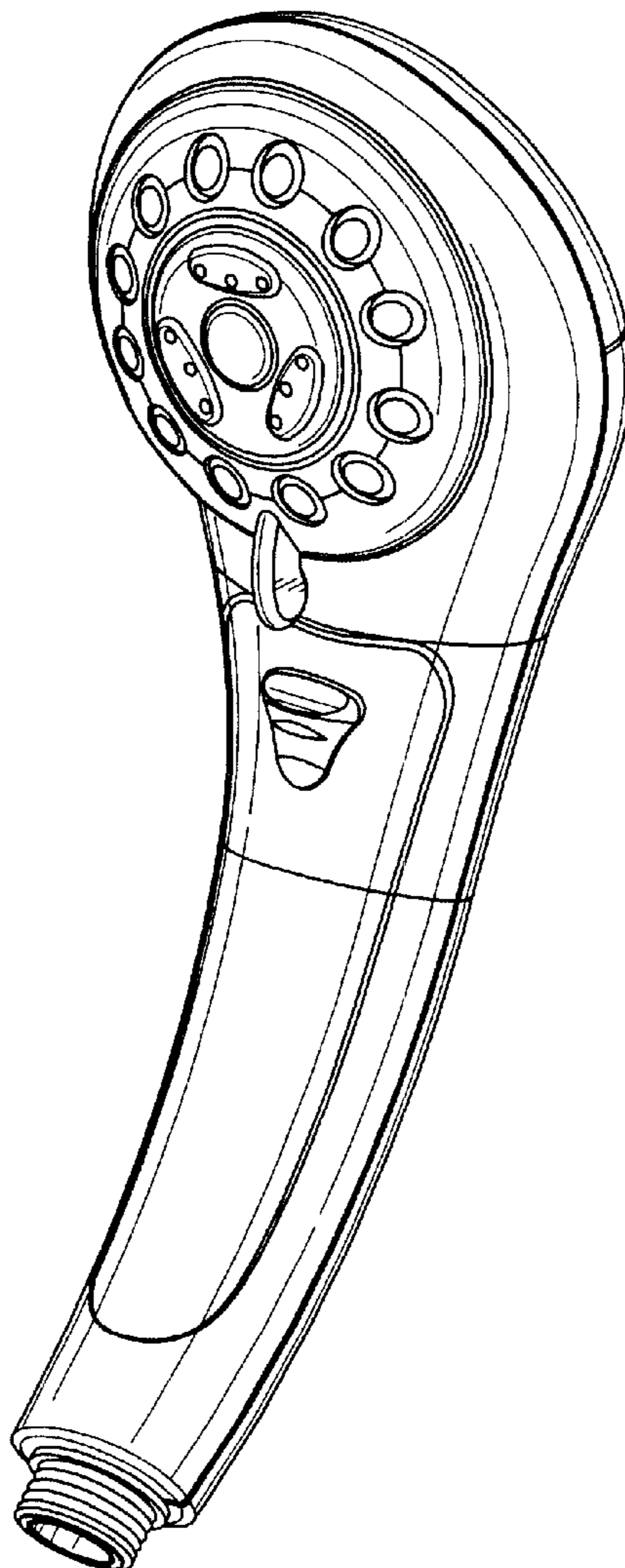

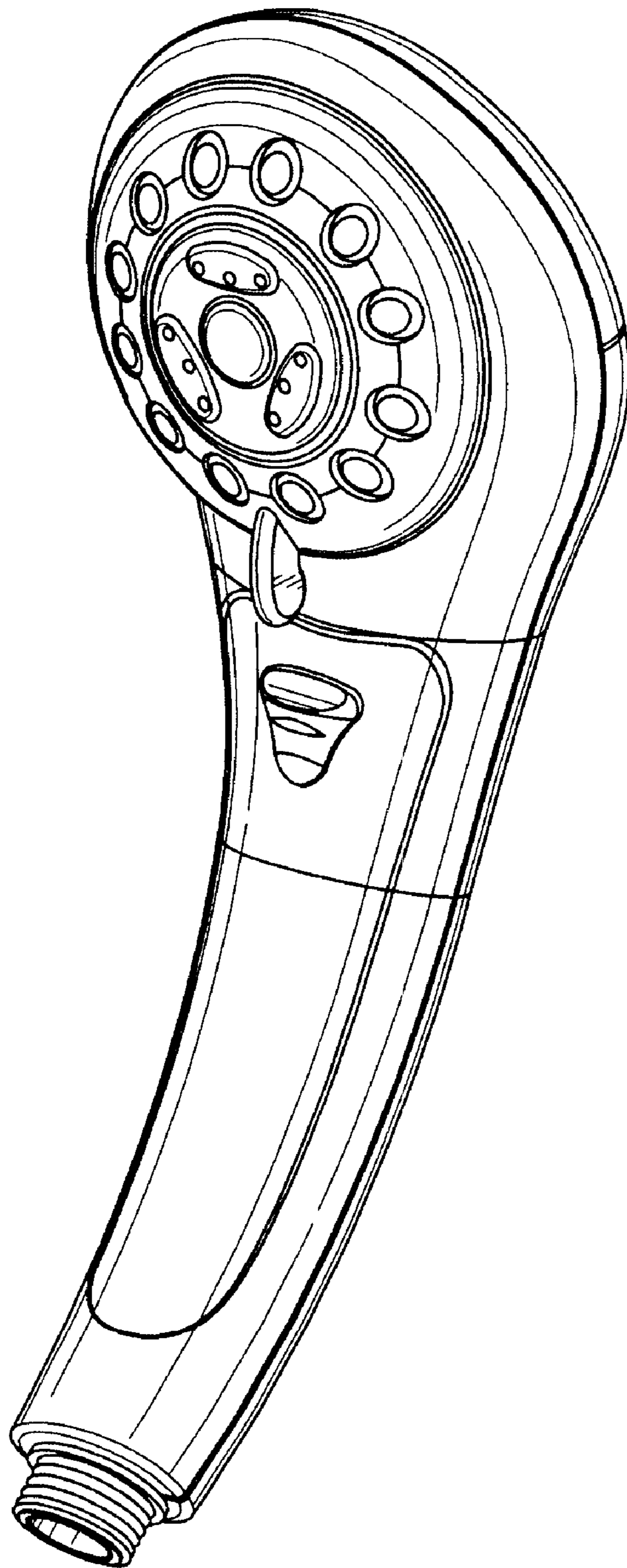

FIG. 1

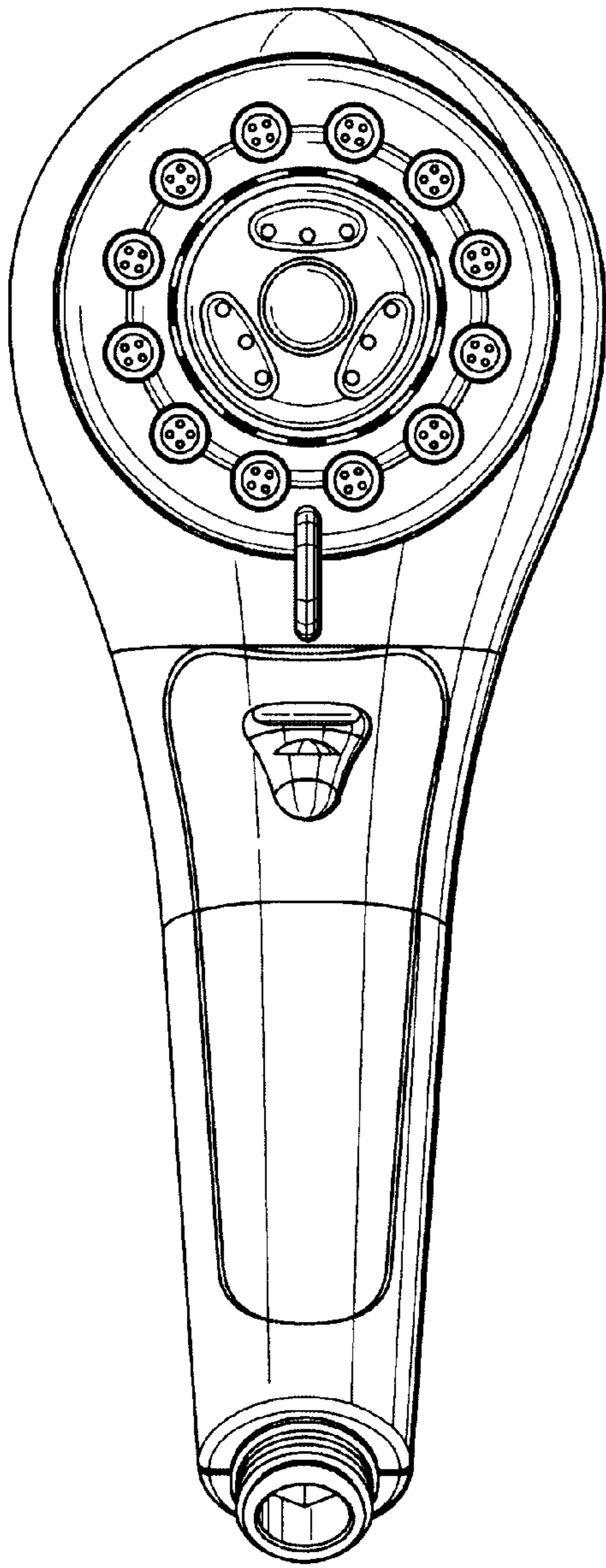

FIG. 2

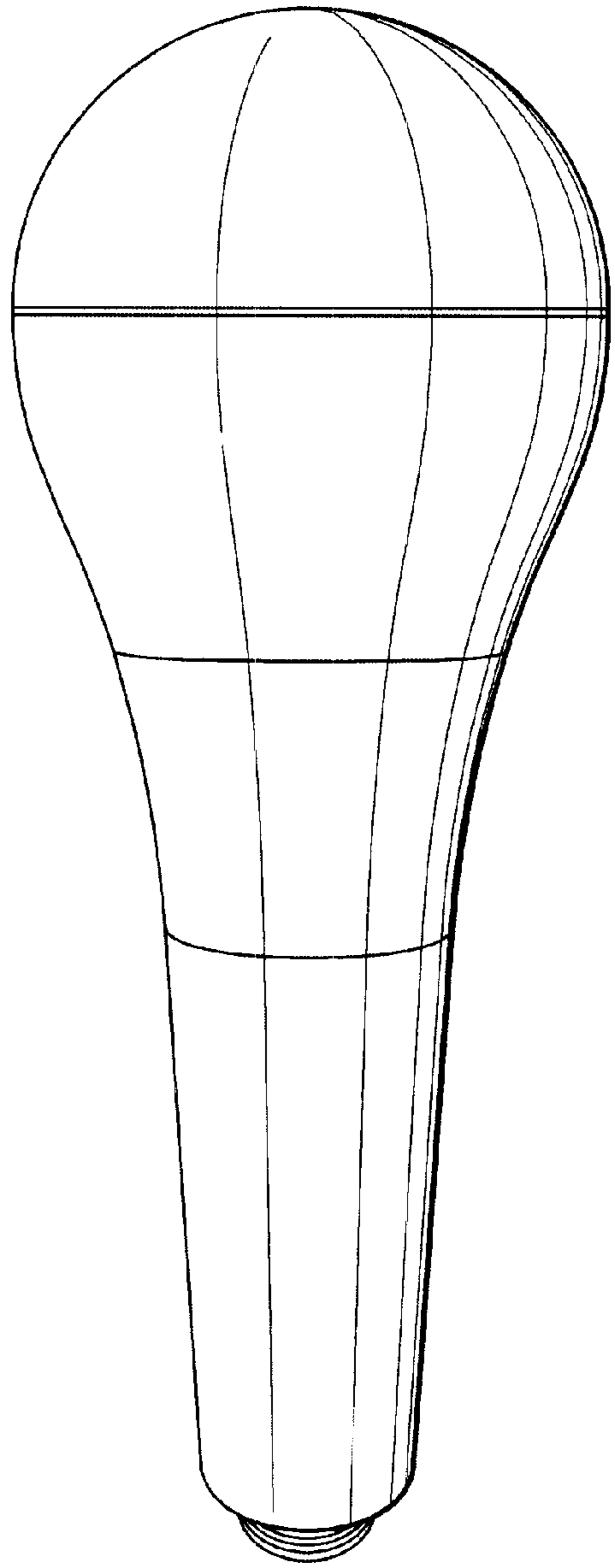

FIG. 3

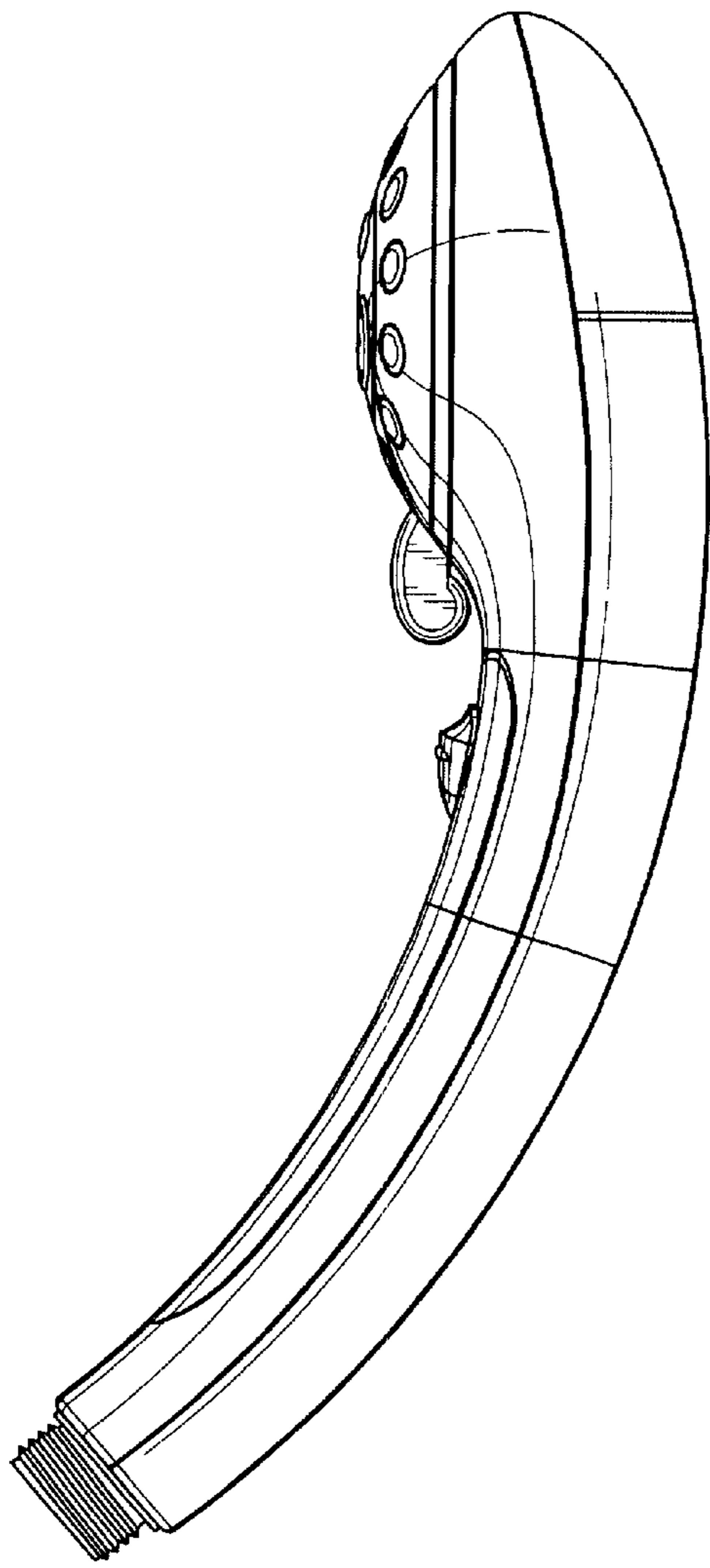

FIG. 4

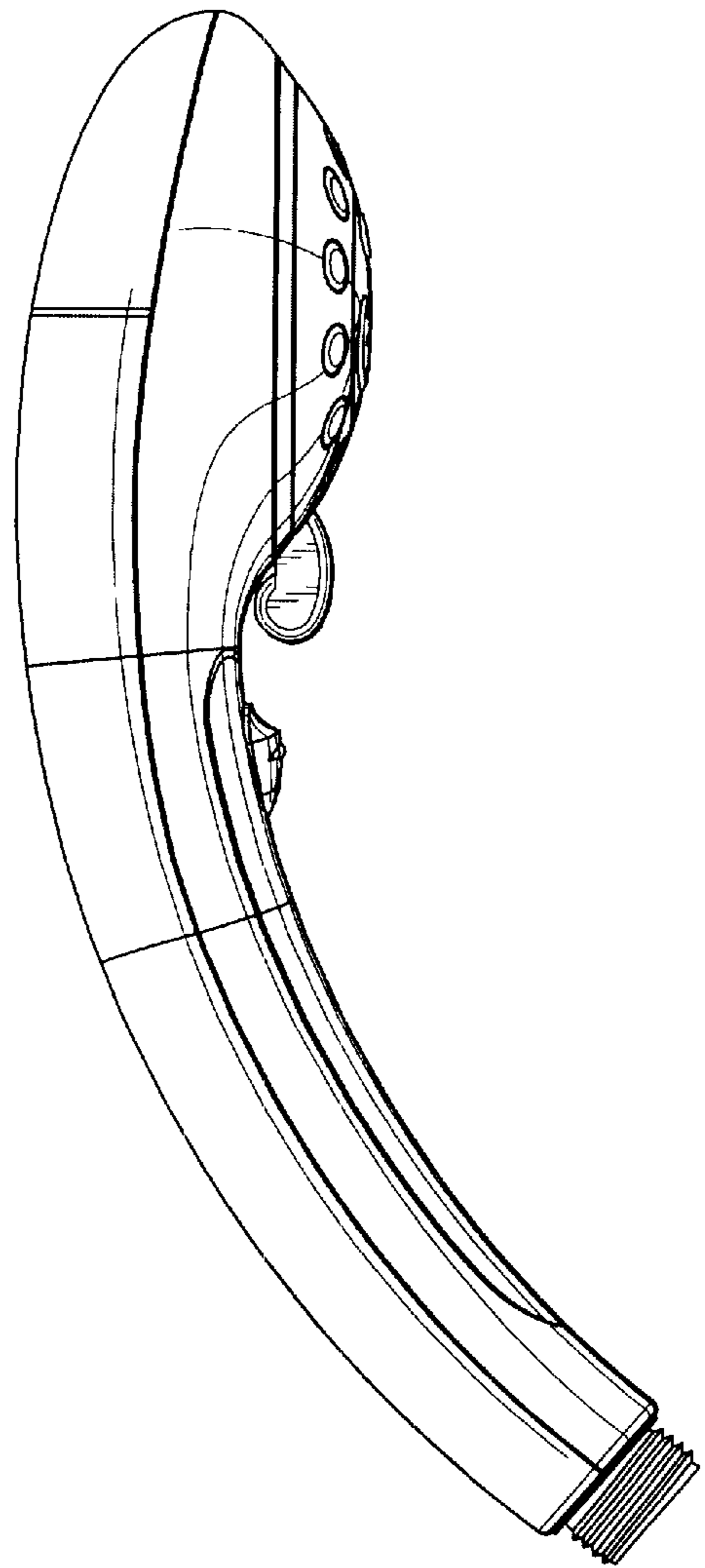

FIG. 5

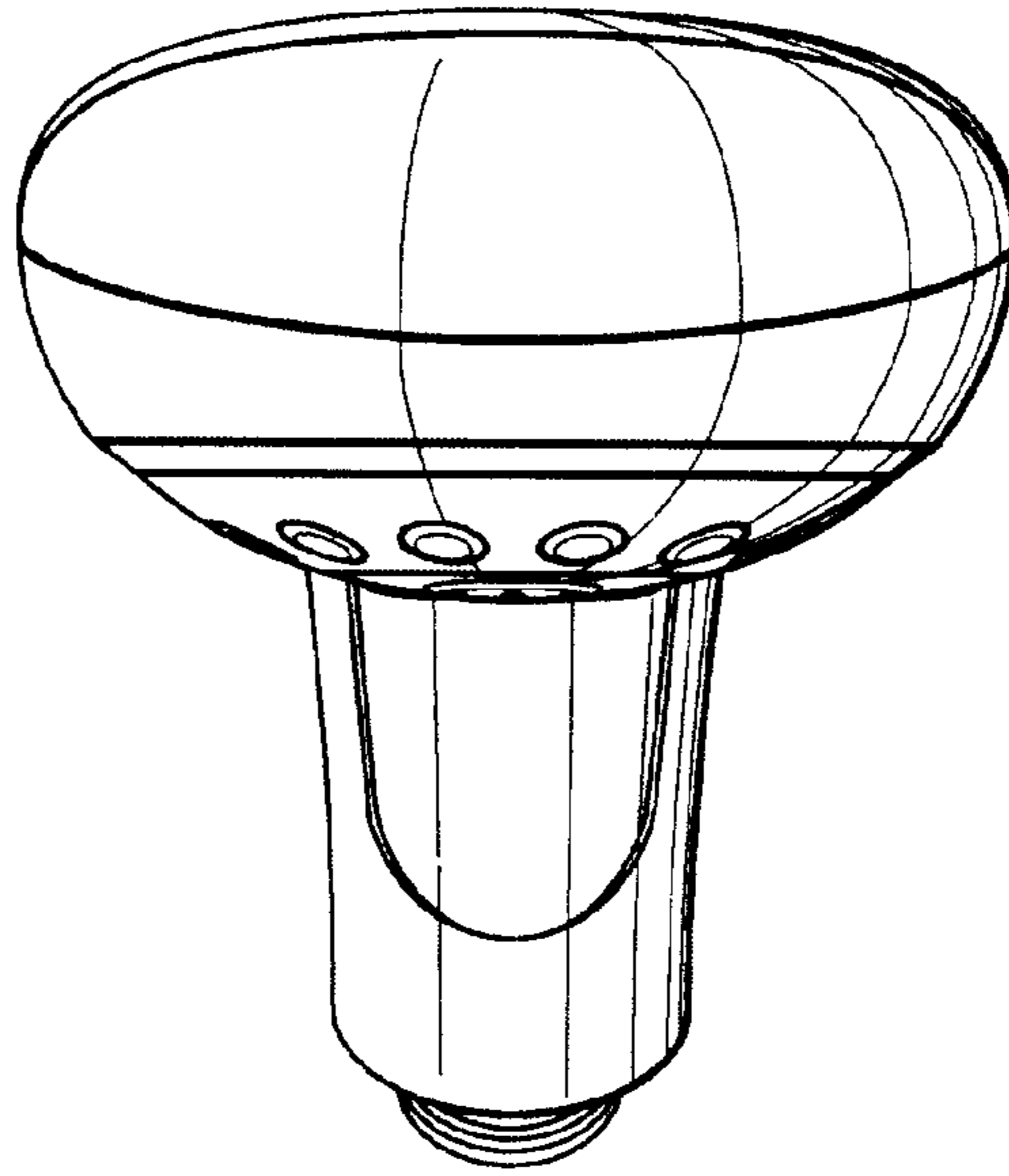

FIG. 6

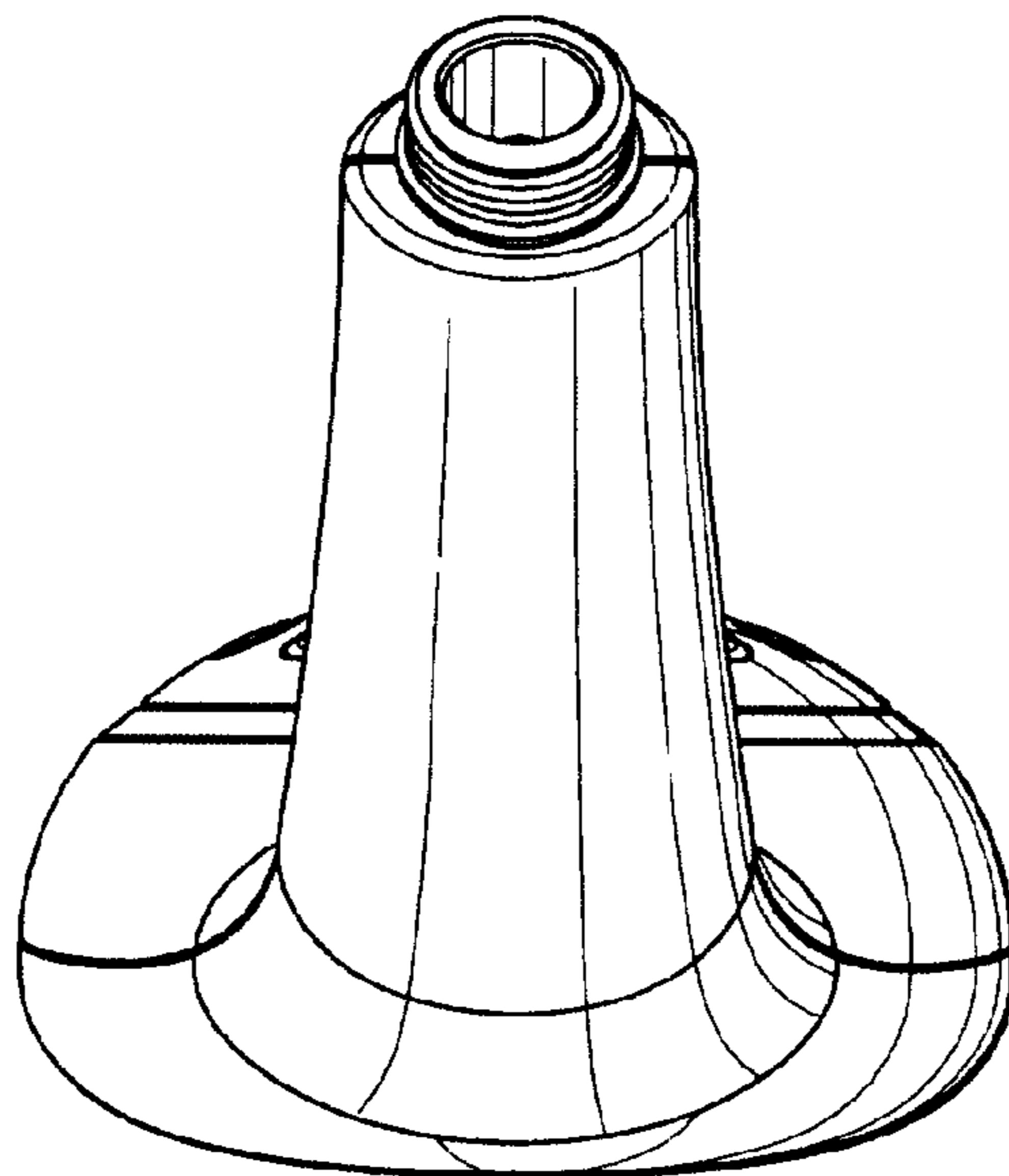

FIG. 7