



US00D466125S

(12) **United States Design Patent**  
**Chien et al.**

(10) **Patent No.:** **US D466,125 S**

(45) **Date of Patent:** **\*\* Nov. 26, 2002**

(54) **COMPUTER FRONT BEZEL**

(75) Inventors: **Chieh Nan Chien**, Taipei (TW); **Fu Ming Chen**, Taipei (TW); **Yin Sheng Yeh**, Taipei (TW)

(73) Assignee: **Hon Hai Precision Ind. Co., Ltd.**, Taipei Hsien (TW)

(\*\*) Term: **14 Years**

(21) Appl. No.: **29/152,065**

(22) Filed: **Nov. 30, 2001**

(51) **LOC (7) Cl.** ..... **14-02**

(52) **U.S. Cl.** ..... **D14/446**

(58) **Field of Search** ..... D14/441-446;  
D13/162, 184, 164, 177, 199; 312/223.2;  
361/680-686, 690-696

(56) **References Cited**

**U.S. PATENT DOCUMENTS**

- 5,169,218 A \* 12/1992 Chu ..... 312/223.2
- D415,141 S \* 10/1999 Jean et al. .... D14/441
- D428,017 S \* 7/2000 Jean et al. .... D14/441
- D431,570 S \* 10/2000 Jean et al. .... D14/441

- D432,135 S \* 10/2000 Jean et al. .... D14/444
- D433,417 S \* 11/2000 Liu et al. .... D14/441
- D435,560 S \* 12/2000 Jean et al. .... D14/444

\* cited by examiner

*Primary Examiner*—Freda Nunn

(74) *Attorney, Agent, or Firm*—Wei Te Chung

(57) **CLAIM**

The ornamental design for a computer front bezel, as shown and described.

**DESCRIPTION**

FIG. 1 is a perspective view of a computer front bezel of our new design;  
 FIG. 2 is a front elevational view thereof;  
 FIG. 3 is a rear elevational view thereof;  
 FIG. 4 is a left side elevational view thereof;  
 FIG. 5 is a right side elevational view thereof;  
 FIG. 6 is a top plan view thereof;  
 FIG. 7 is a bottom plan view thereof; and,  
 FIG. 8 is a view similar to FIG. 1 with the computer front bezel being mounted to a computer case which is shown in broken lines for illustrative purpose only and forms no part of the claimed design.

**1 Claim, 6 Drawing Sheets**

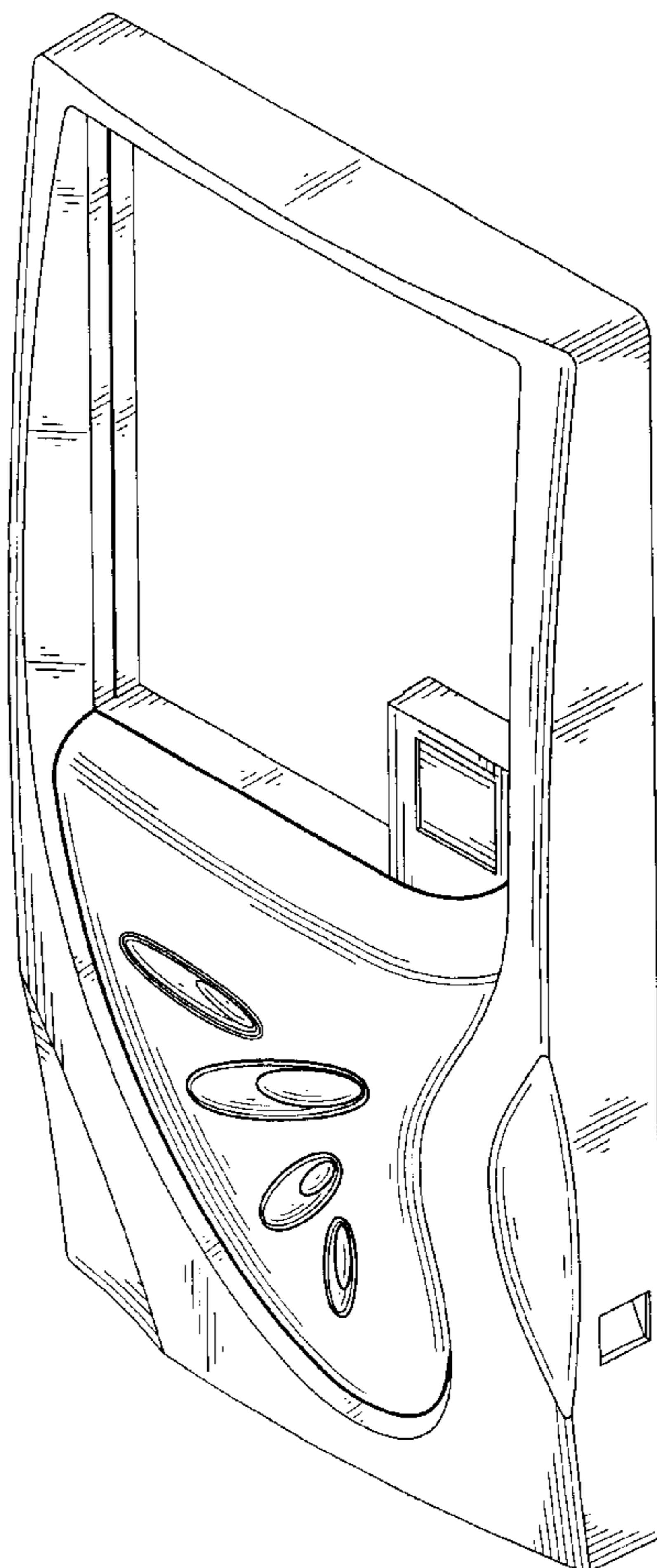

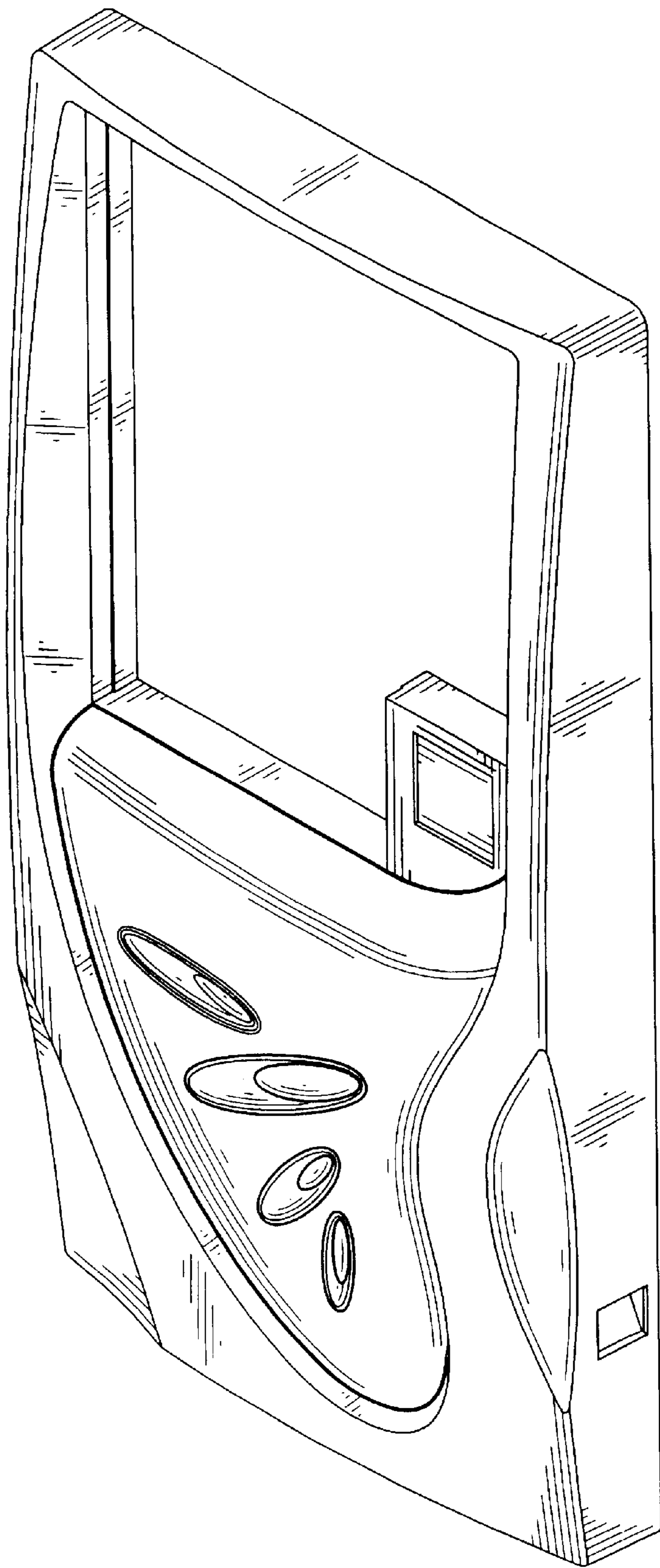

FIG. 1

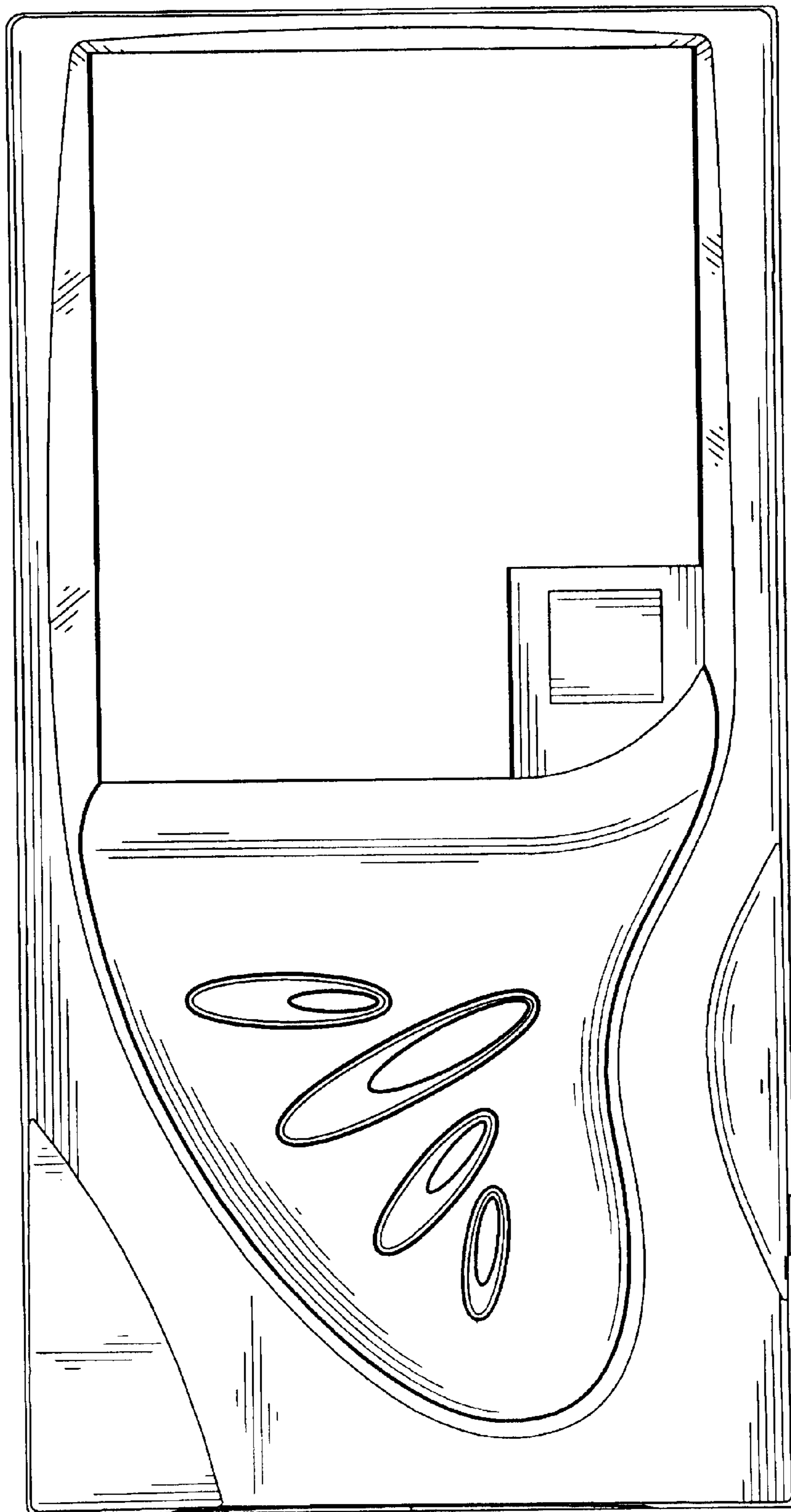

FIG. 2

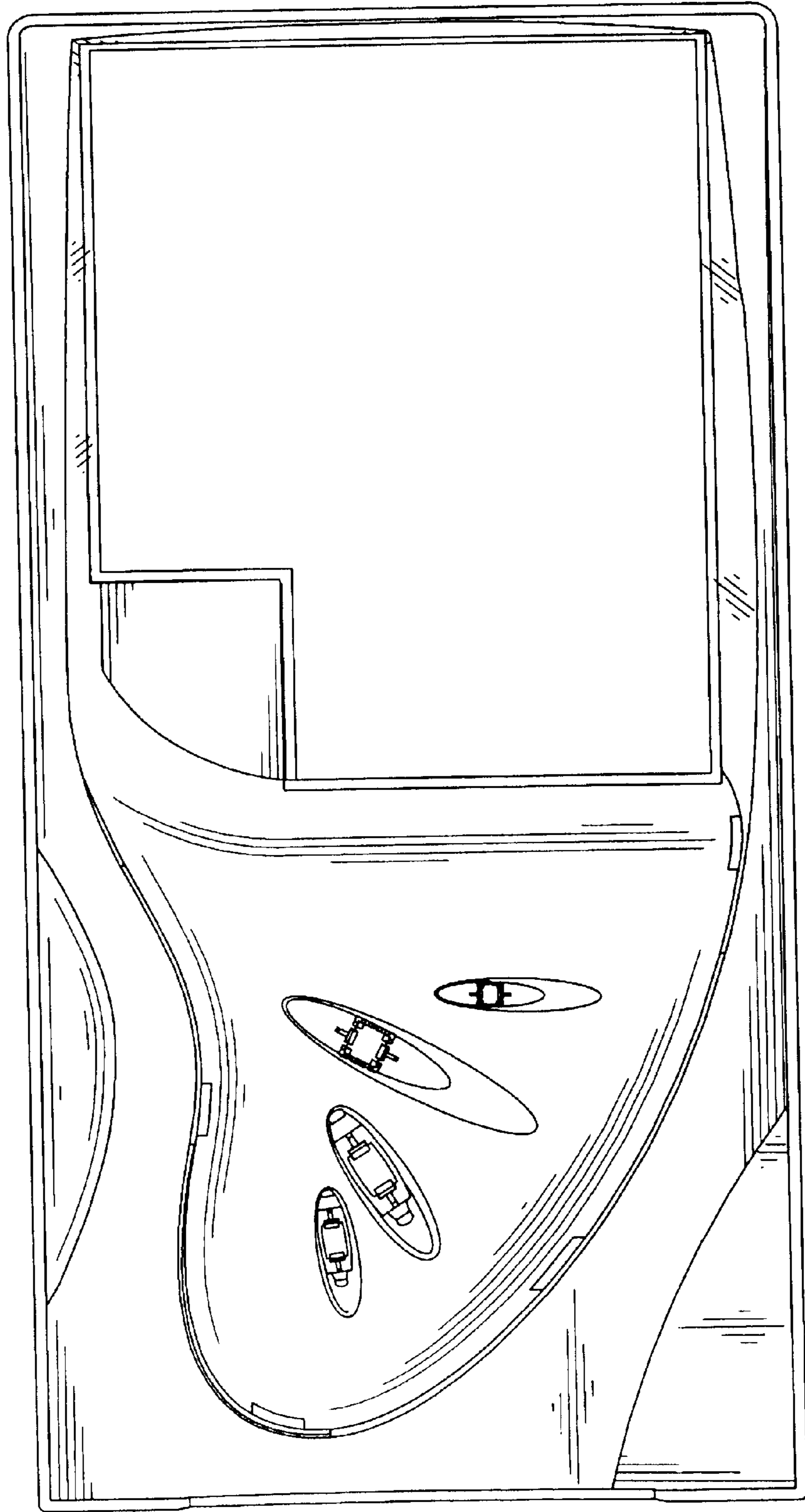

FIG. 3

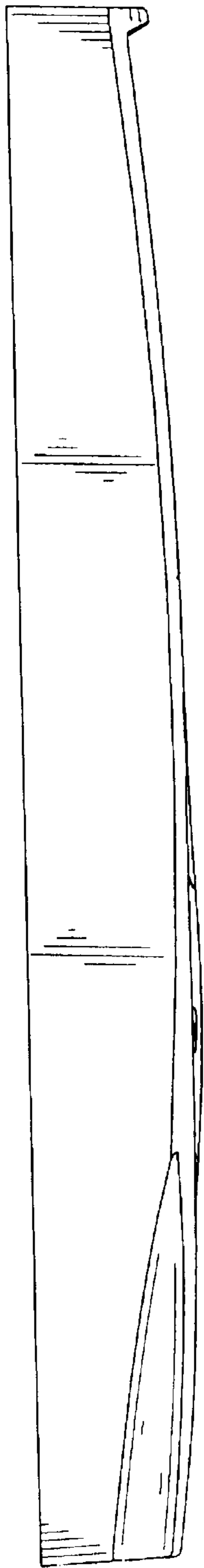

FIG. 4

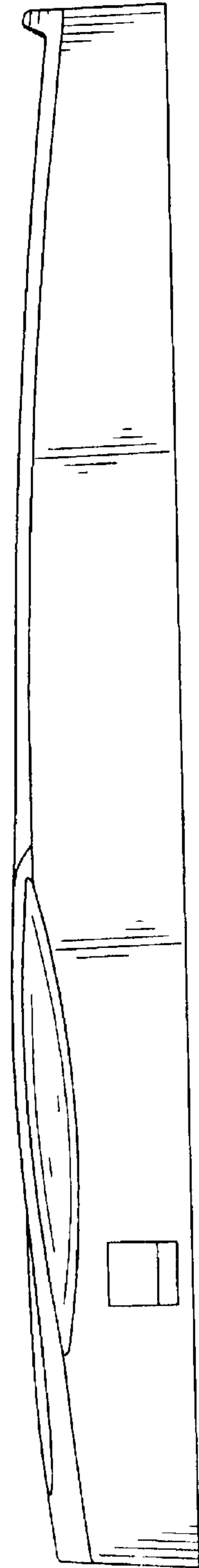

FIG. 5

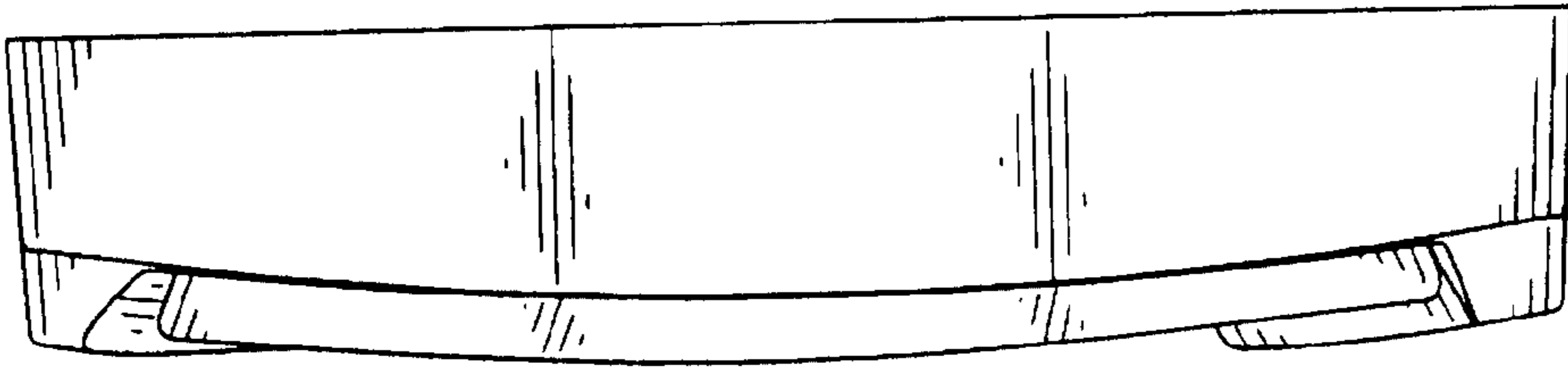

FIG. 6



FIG. 7

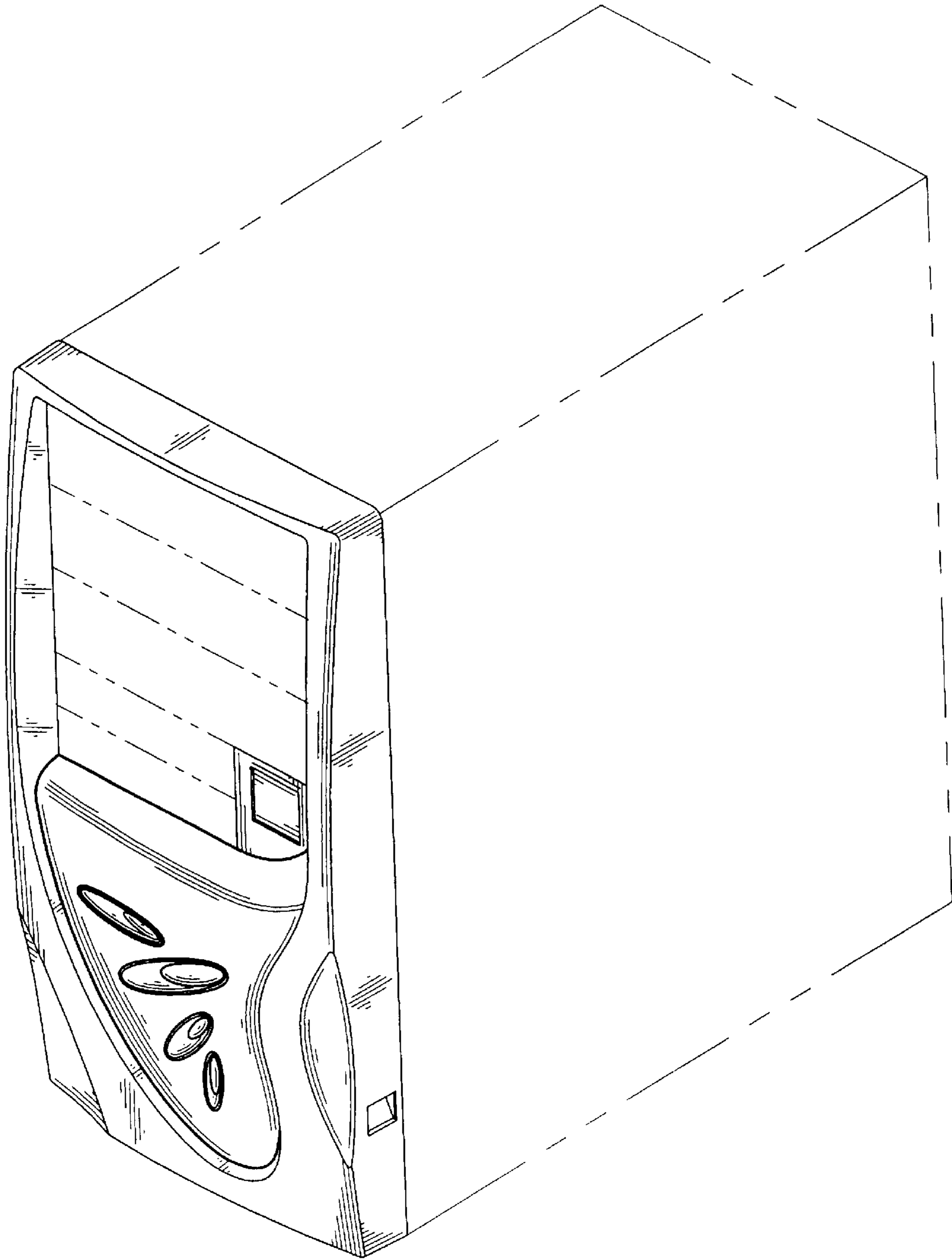

FIG. 8