



US00D466118S

(12) **United States Design Patent**  
**Lee**

(10) **Patent No.:** **US D466,118 S**

(45) **Date of Patent:** **\*\* Nov. 26, 2002**

(54) **MONITOR FOR A COMPUTER**

(75) Inventor: **Eun Seog Lee**, Seoul (KR)

(73) Assignee: **Tophead.com**, Seoul (KR)

(\*\*) Term: **14 Years**

(21) Appl. No.: **29/143,228**

(22) Filed: **Jun. 13, 2001**

(51) **LOC (7) Cl.** ..... **14-02**

(52) **U.S. Cl.** ..... **D14/375**

(58) **Field of Search** ..... D14/371, 374,  
D14/375, 329, 314, 326, 376, 125-129;  
345/104, 156, 168, 173; 348/180, 184,  
325, 739; 349/1, 2, 11, 62; 248/918-924

(56) **References Cited**

**U.S. PATENT DOCUMENTS**

D408,375 S \* 4/1999 Oba ..... D14/329

D410,441 S \* 6/1999 Lin ..... D14/314

D433,409 S \* 11/2000 Chen ..... D14/326

\* cited by examiner

*Primary Examiner*—Freda Nunn

(74) *Attorney, Agent, or Firm*—Rosenberg, Klein & Lee

(57) **CLAIM**

The ornamental design for a monitor for a computer, as shown and described.

**DESCRIPTION**

FIG. 1 is a perspective view of the monitor for computer showing my new design;

FIG. 2 is a front view thereof;

FIG. 3 is the rear view thereof;

FIG. 4 is the left side view thereof;

FIG. 5 is the right side view thereof;

FIG. 6 is the top view thereof; and,

FIG. 7 is the bottom view thereof.

**1 Claim, 4 Drawing Sheets**

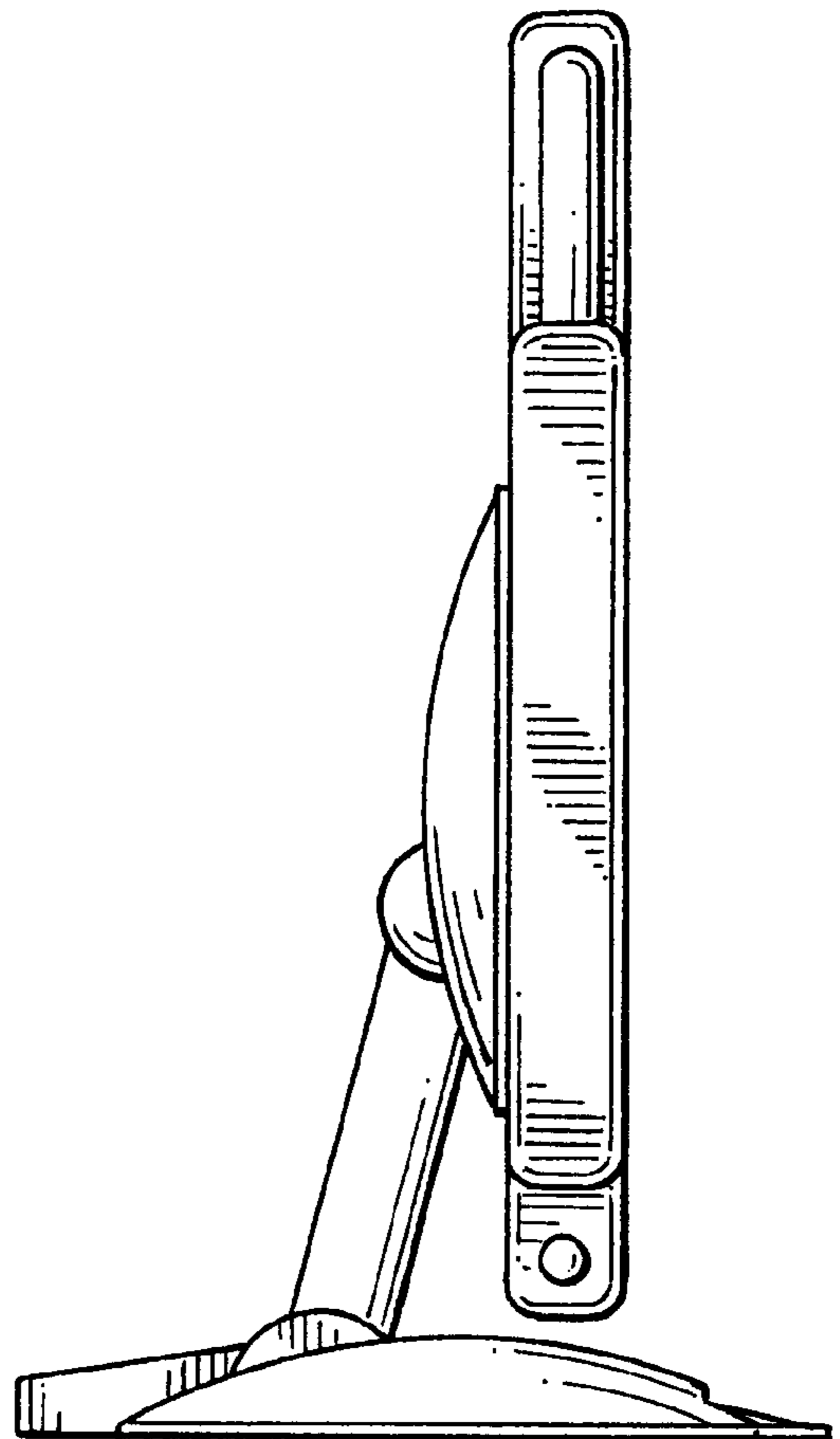
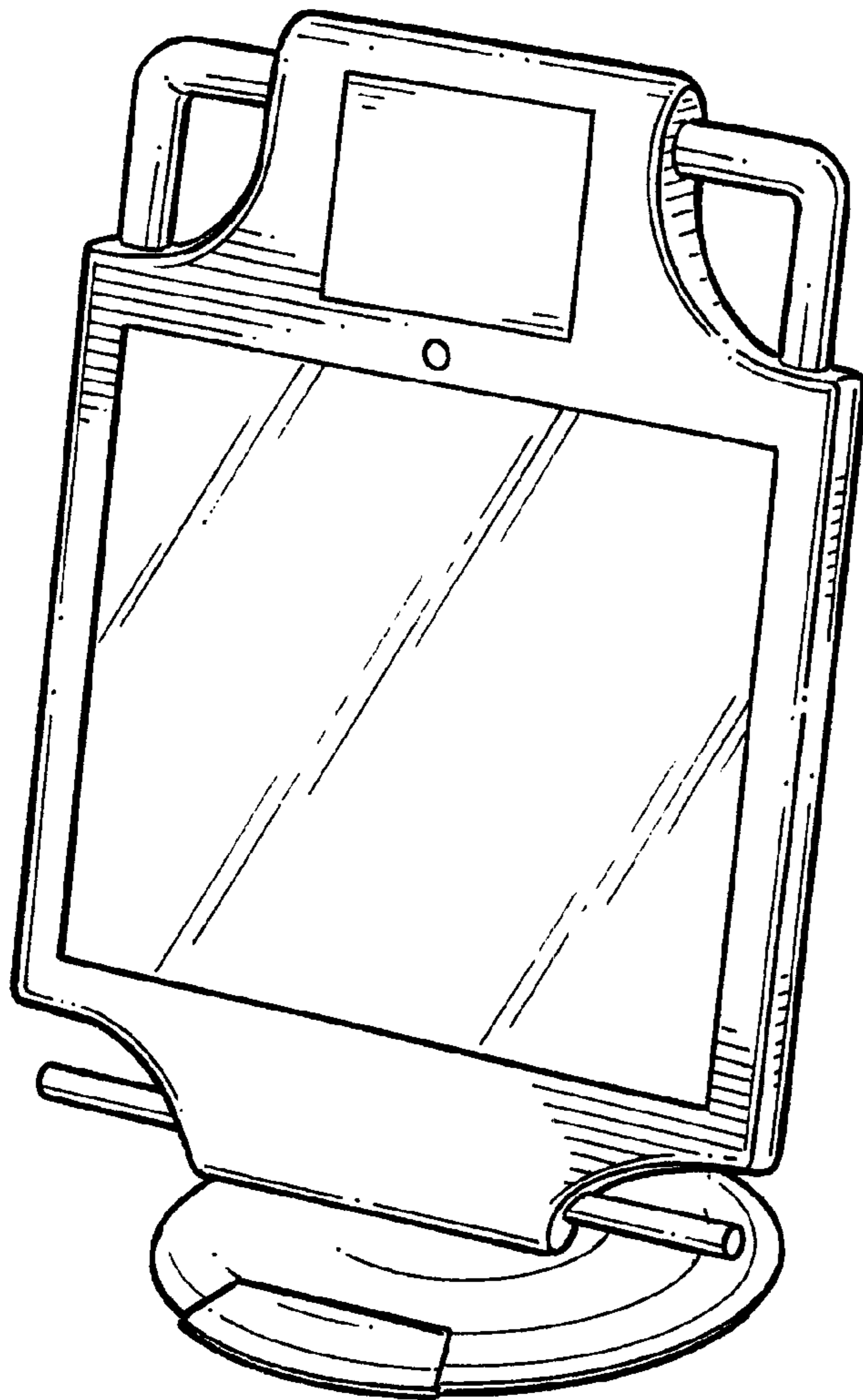

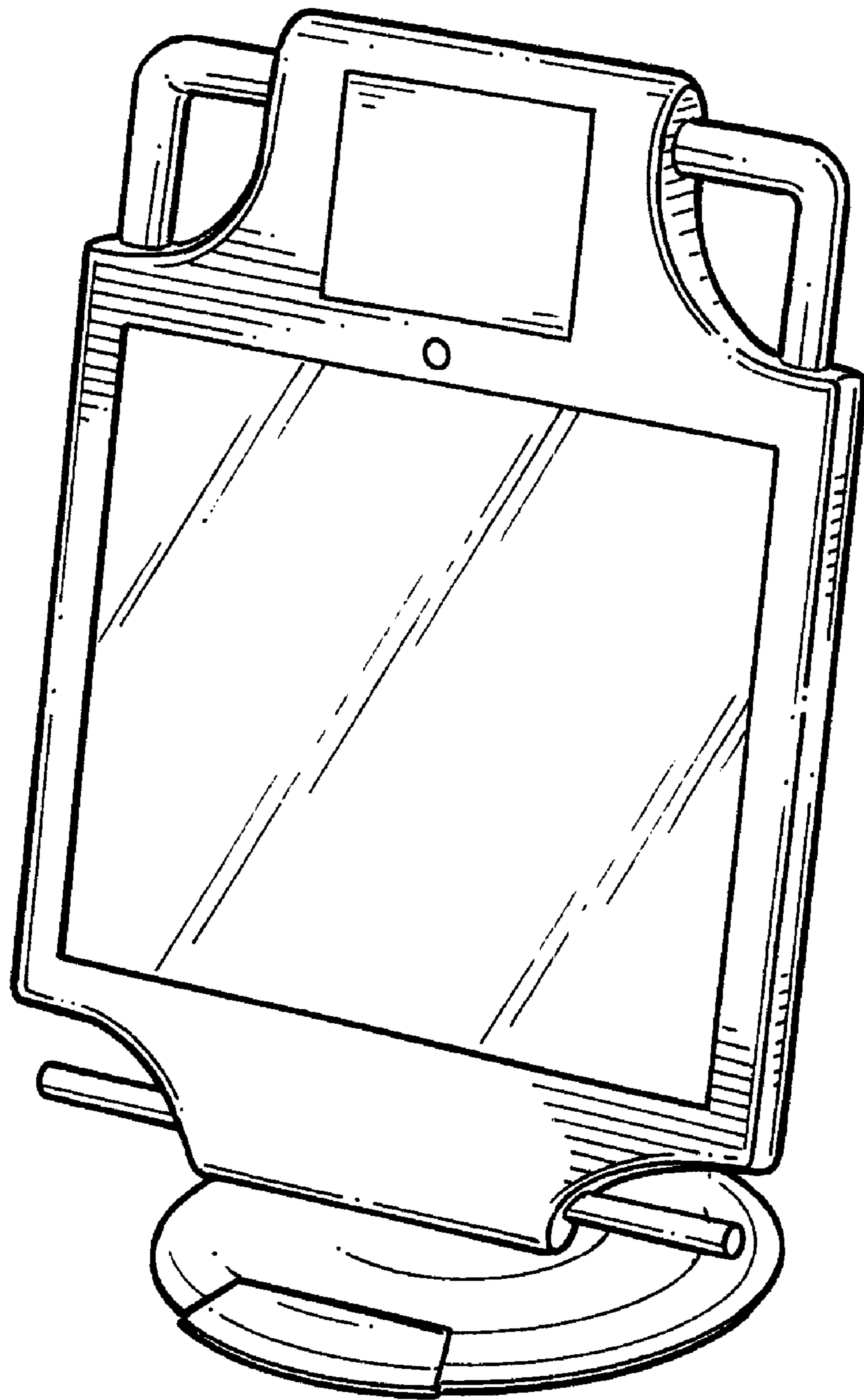

FIG. 1

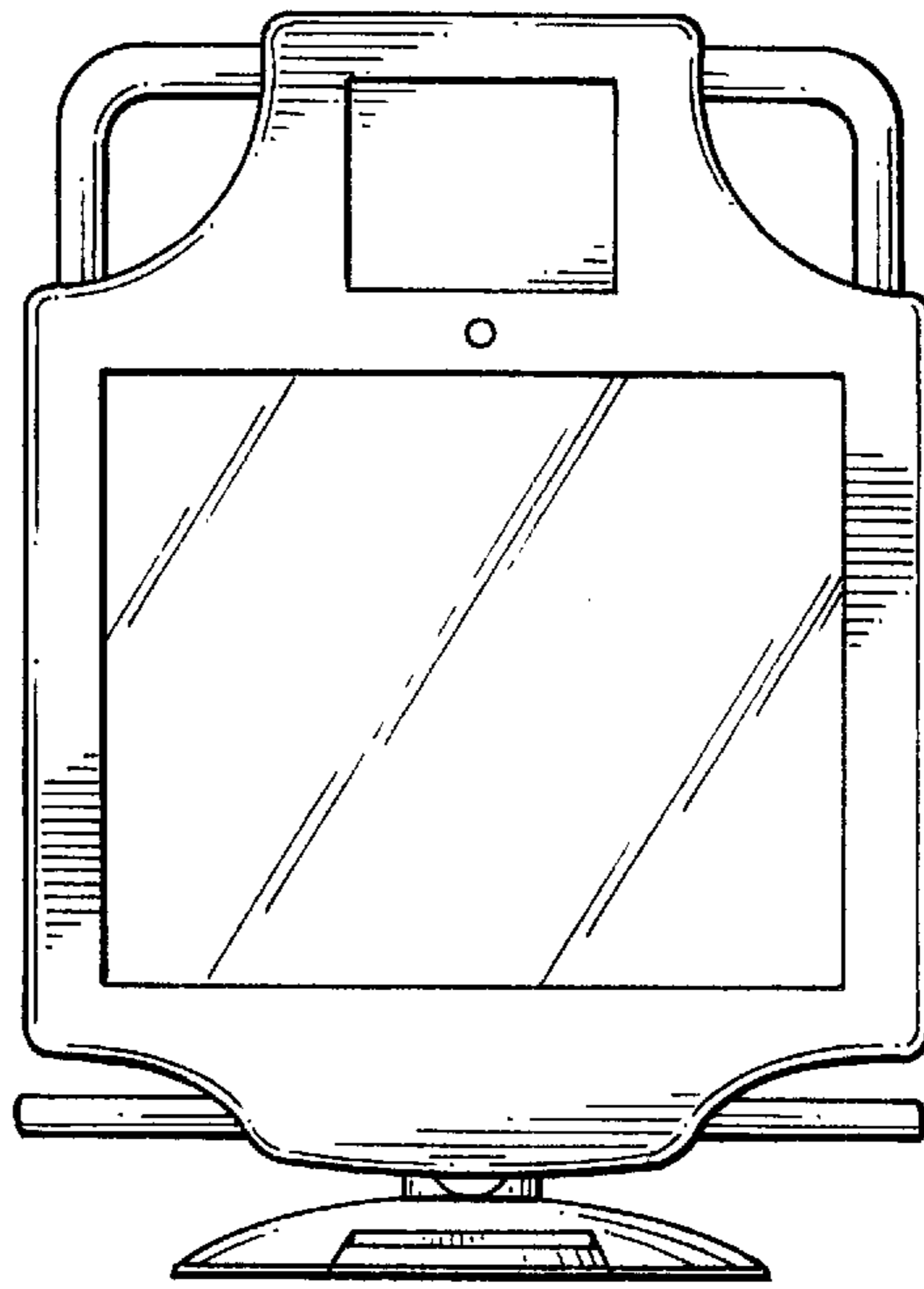

FIG. 2

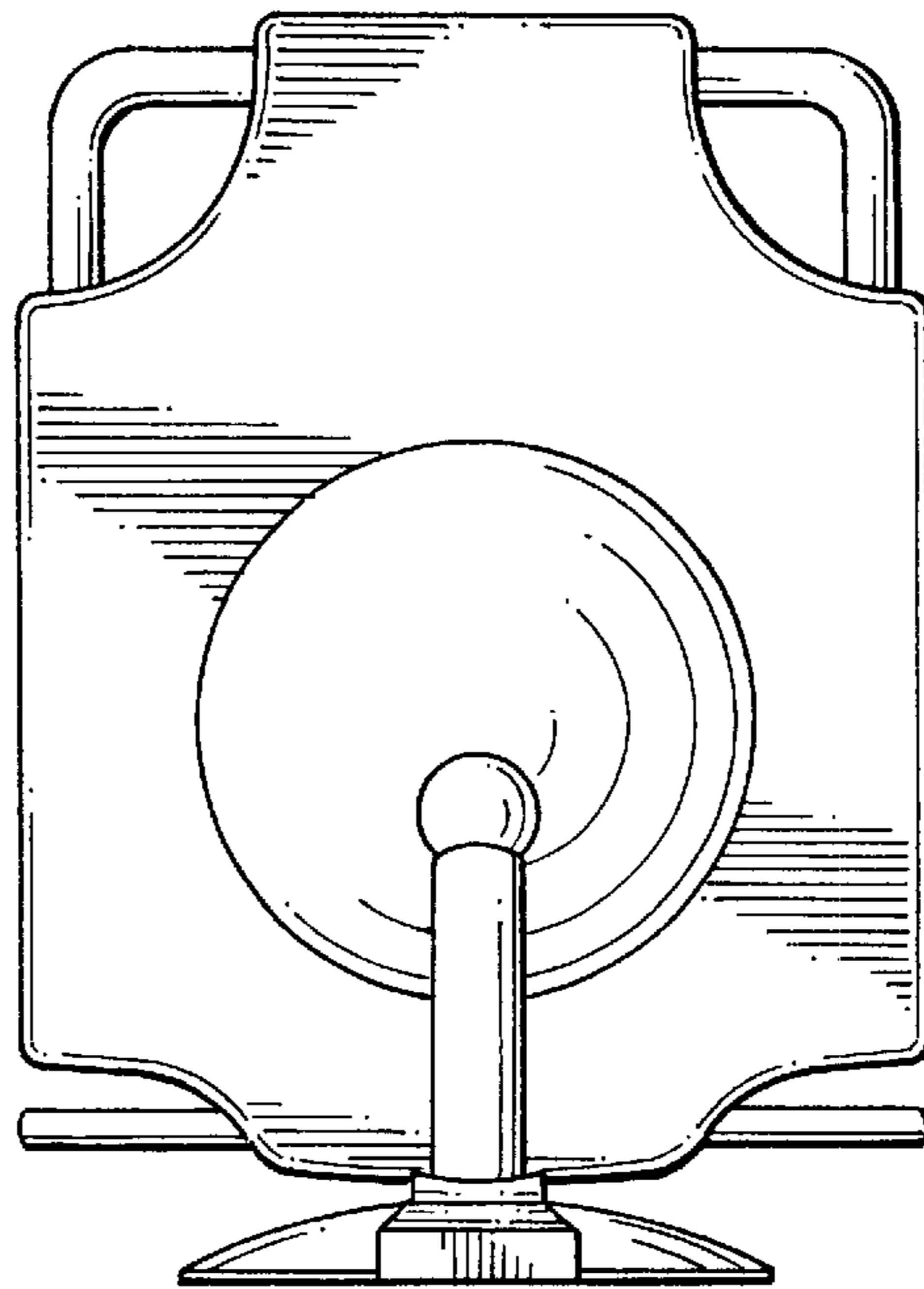

FIG. 3

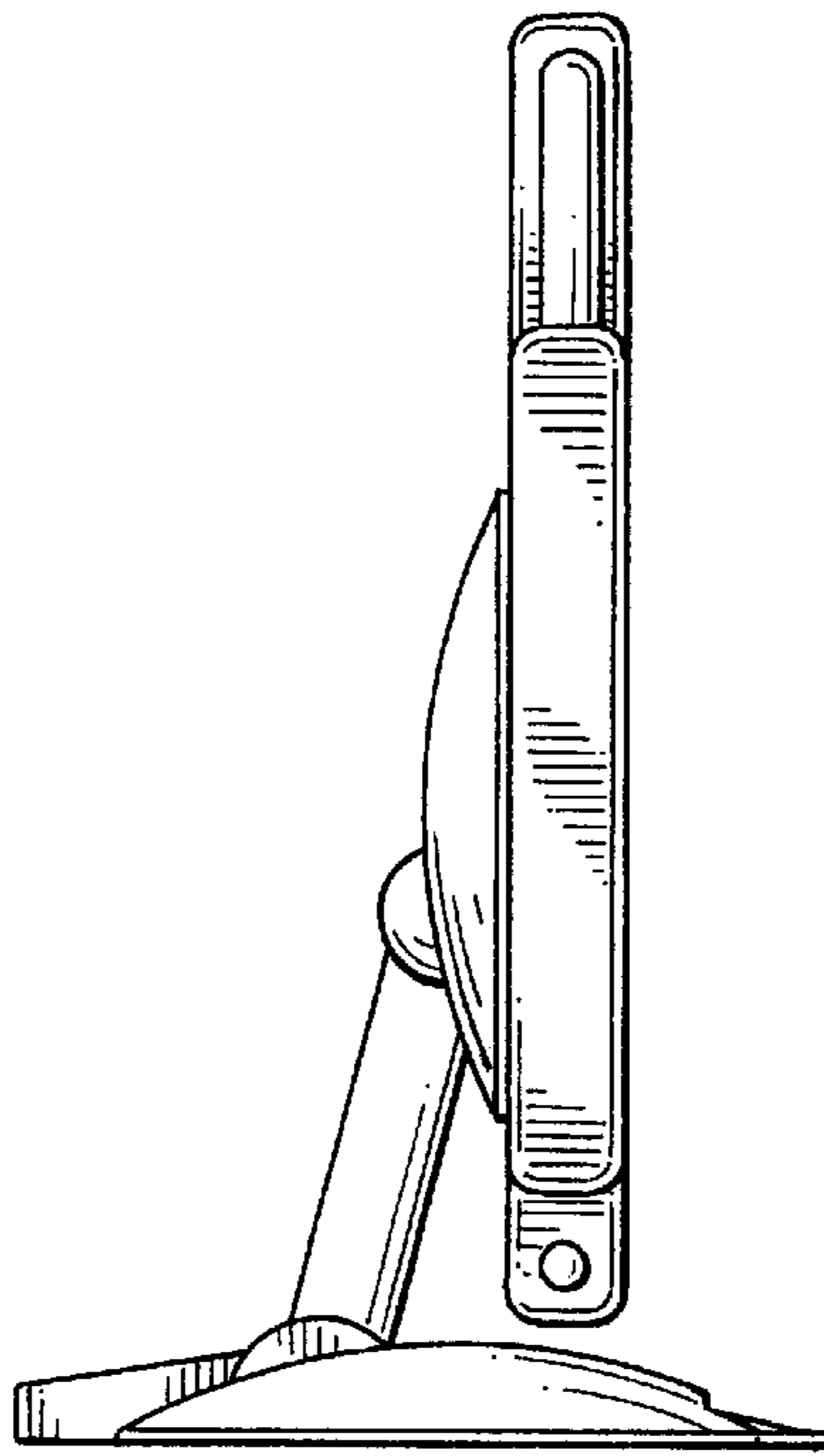

FIG. 4

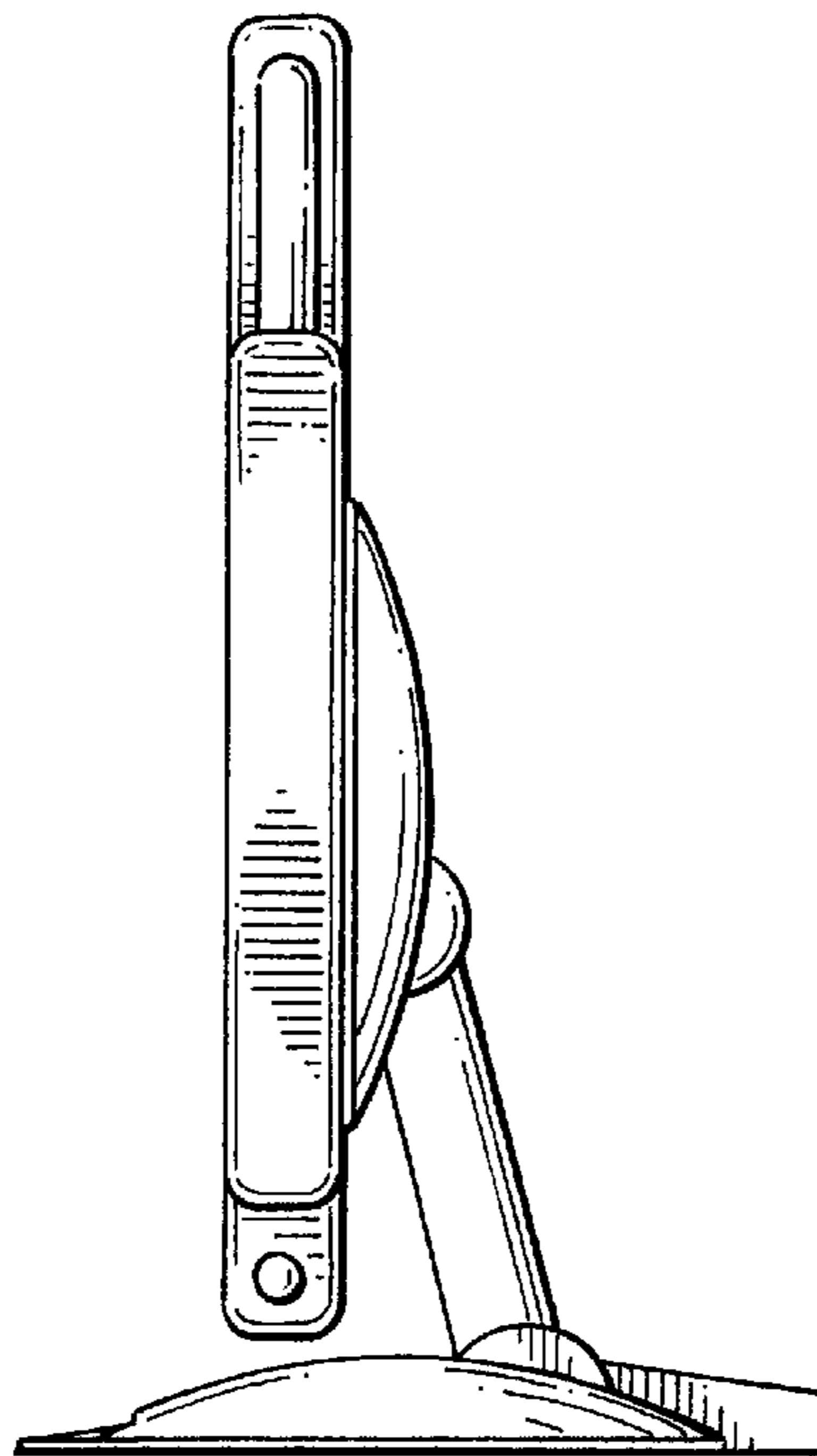

FIG. 5

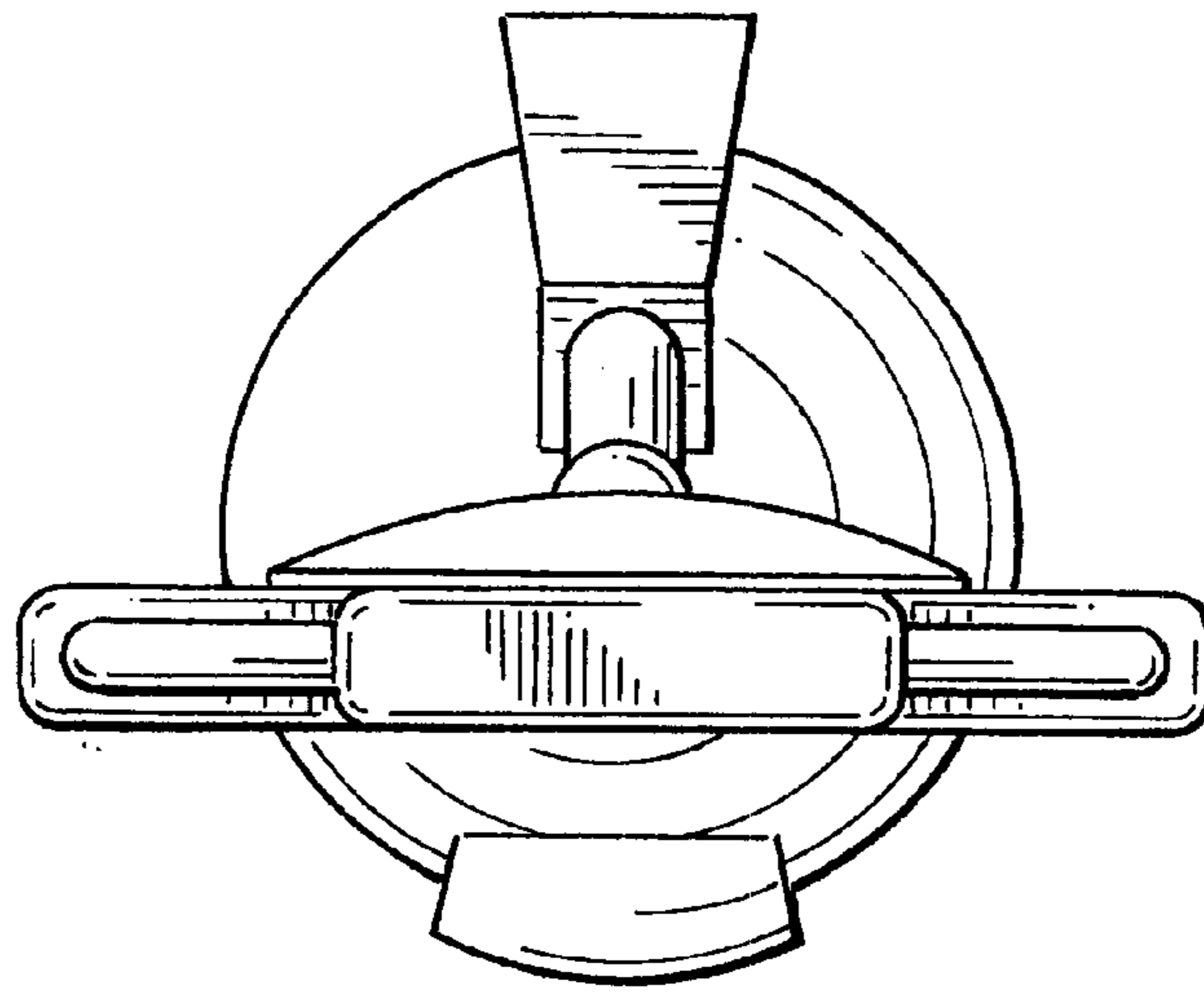

FIG. 6

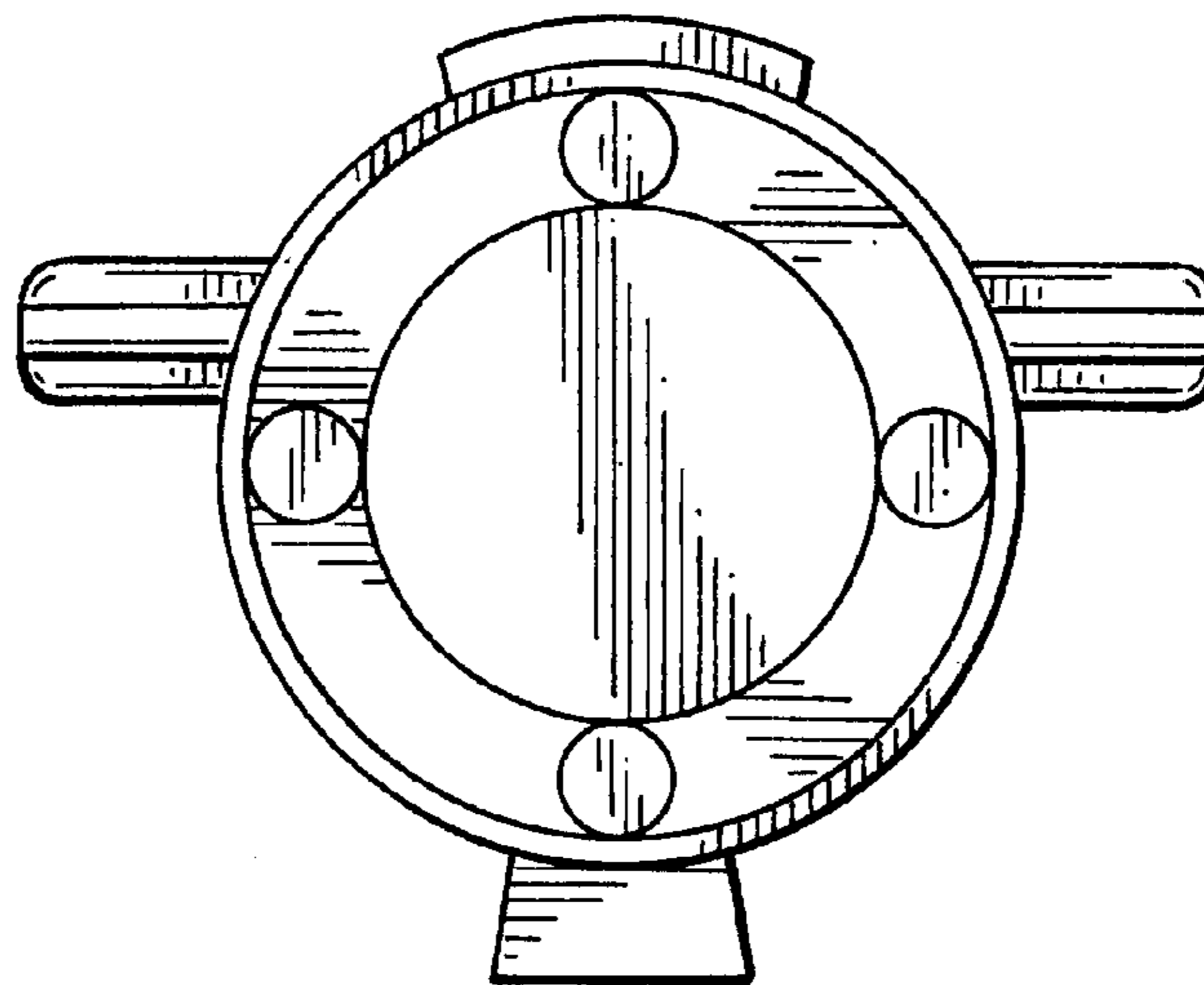

FIG. 7