



US00D465960S

(12) **United States Design Patent** (10) **Patent No.:** **US D465,960 S**  
**Yau** (45) **Date of Patent:** **\*\* Nov. 26, 2002**

(54) **DISK HOLDER**

(75) Inventor: **Chor Chi Yau, Shatin (CN)**

(73) Assignee: **Rush Land Limited, Hong Kong (CN)**

(\*\*) Term: **14 Years**

(21) Appl. No.: **29/150,503**

(22) Filed: **Nov. 14, 2001**

(51) **LOC (7) Cl.** ..... **06-04**

(52) **U.S. Cl.** ..... **D6/632; D6/407; D6/634**

(58) **Field of Search** ..... **D3/201, 218, 272, D3/273, 276, 905; D6/407, 626-635; D9/337, 445, 454; D19/26, 27, 32, 65, 75-77, 81; D28/77; 206/232, 307.1, 308.1, 308.2, 308.3, 309-310, 311, 312, 313, 387.11, 387.13, 387.15; 312/9.57, 902, 9.9, 9.48, 9.55, 9.64, 9.47, 9.53, 328; 379/355**

(56) **References Cited**

**U.S. PATENT DOCUMENTS**

5,788,068	A	*	8/1998	Fraser et al.	206/310
D411,071	S	*	6/1999	Cerda-Vicedo	D6/632
5,944,181	A	*	8/1999	Lau	206/308.1
5,996,788	A	*	12/1999	Belden, Jr. et al.	206/310
D420,240	S	*	2/2000	Sorenson et al.	D6/632
6,155,417	A	*	12/2000	Flores, Jr. et al.	206/308.1
6,164,446	A	*	12/2000	Law	206/308.1
D437,171	S	*	2/2001	Cuadrado-Serena	D6/632
D437,520	S	*	2/2001	Choi	D6/632
6,206,185	B1	*	3/2001	Ke et al.	206/308.1
6,206,186	B1	*	3/2001	Cerda-Vilaplana et al.	206/308.1
6,227,362	B1	*	5/2001	Cheung	206/308.1
6,237,763	B1	*	5/2001	Lau	206/308.1

6,250,461	B1	*	6/2001	Hu	206/310
6,293,396	B1	*	9/2001	Takahashi et al.	206/310
D450,973	S	*	11/2001	Bieda	D6/632
D451,747	S	*	12/2001	Tang	D6/632
D452,104	S	*	12/2001	Tang	D6/632
D452,105	S	*	12/2001	Chan	D6/635
D452,793	S	*	1/2002	Lee	D6/632
D455,595	S	*	4/2002	Ikeda et al.	D6/632
6,364,107	B1	*	4/2002	Flores, Jr. et al.	206/308.1
2001/0021167	A1	*	9/2001	Kutaragi et al.	
2001/0032792	A1	*	10/2001	Cheung	
2001/0047947	A1	*	12/2001	Lau	
2002/0014421	A1	*	2/2002	Byrne et al.	
2002/0033348	A1	*	3/2002	Flores, Jr. et al.	

\* cited by examiner

*Primary Examiner*—Celia Murphy

(74) *Attorney, Agent, or Firm*—Alix, Yale & Ristas, LLP

(57) **CLAIM**

The ornamental design for a disk holder, as shown and described.

**DESCRIPTION**

FIG. 1 is a front perspective view of the disk holder showing my new design;  
FIG. 2 is a top plan view of the disk holder of FIG. 1;  
FIG. 3 is a front view of the disk holder of FIG. 1;  
FIG. 4 is a left side view of the disk holder of FIG. 1;  
FIG. 5 is a right side view of the disk holder of FIG. 1;  
FIG. 6 is a rear view of the disk holder of FIG. 1;  
FIG. 7 is a bottom plan view of the disk holder of FIG. 1;  
and,  
FIG. 8 is a front perspective view in an opened position of the disk holder of FIG. 1.

**1 Claim, 5 Drawing Sheets**

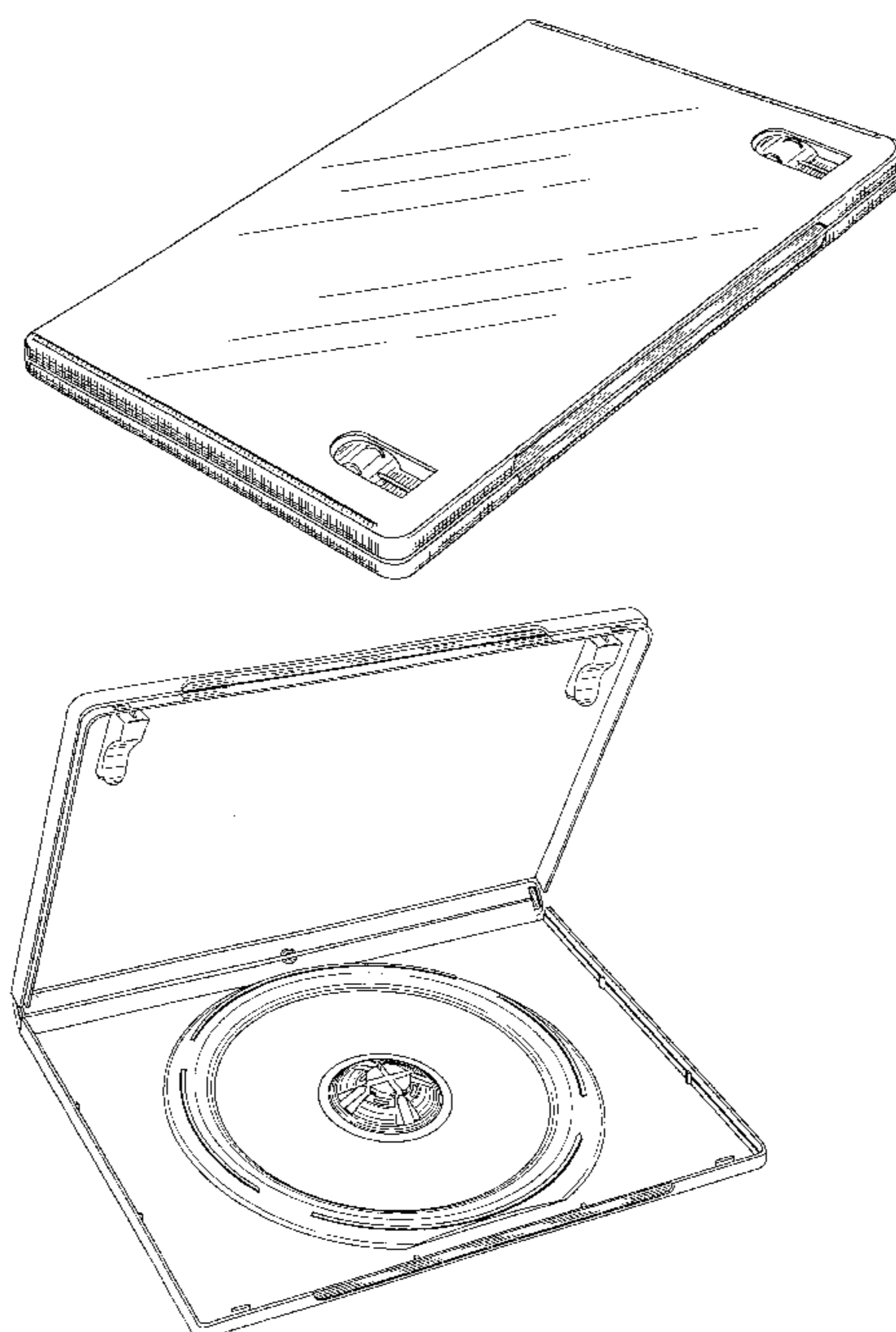

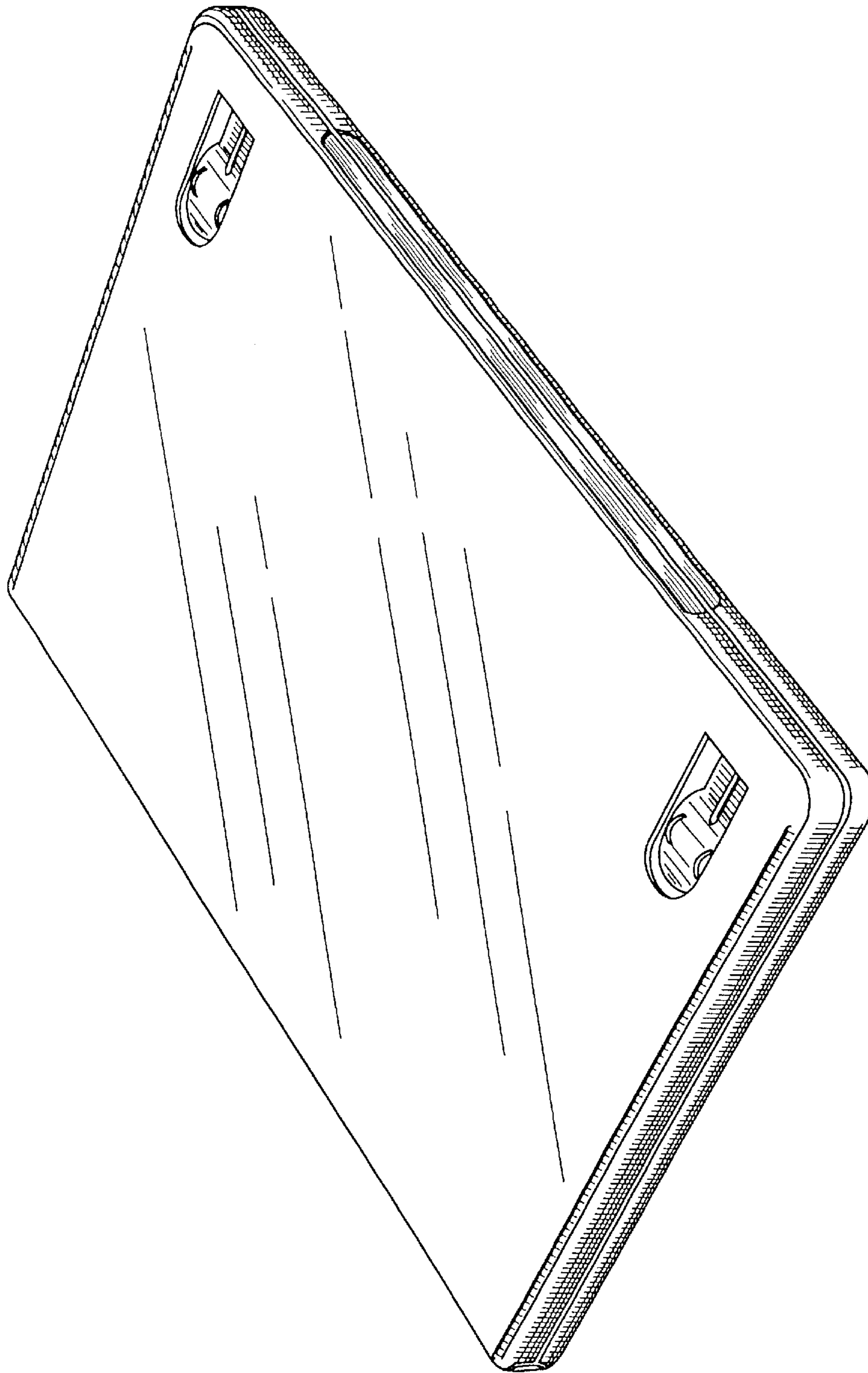

Fig. 1

Fig.2

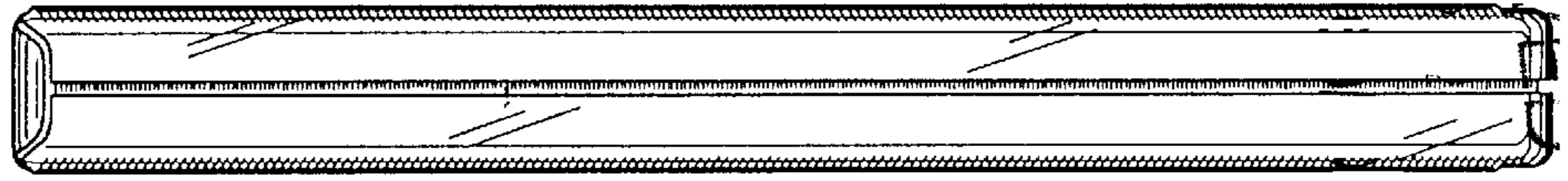
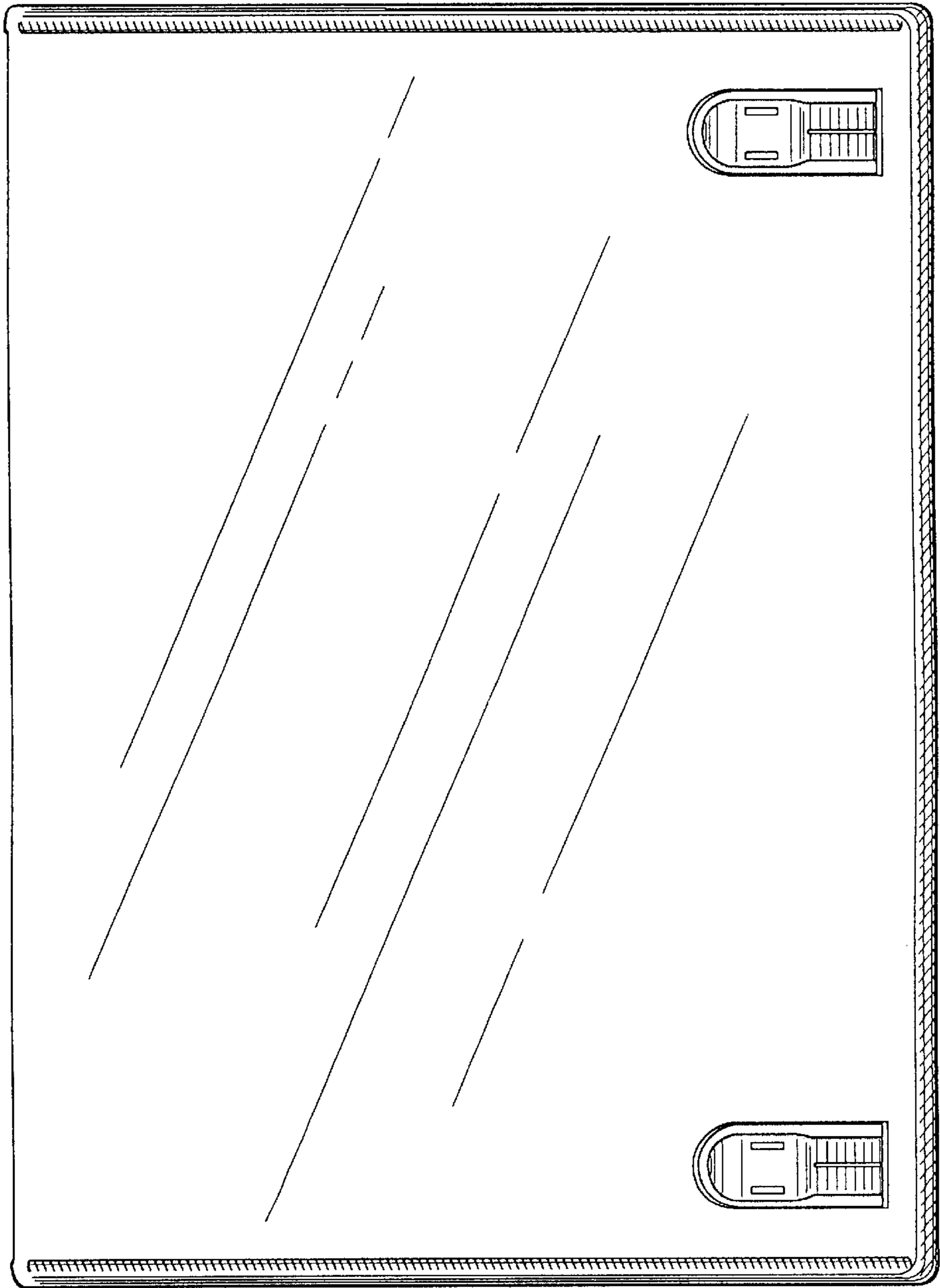

Fig.3



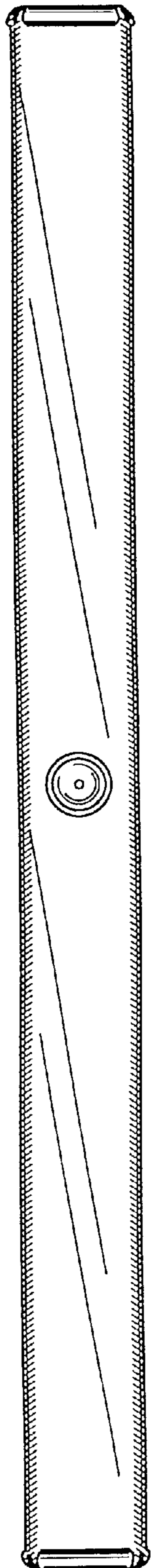

Fig.4

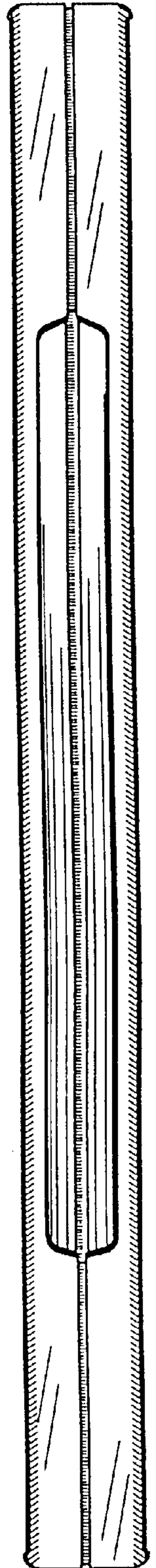

Fig.5

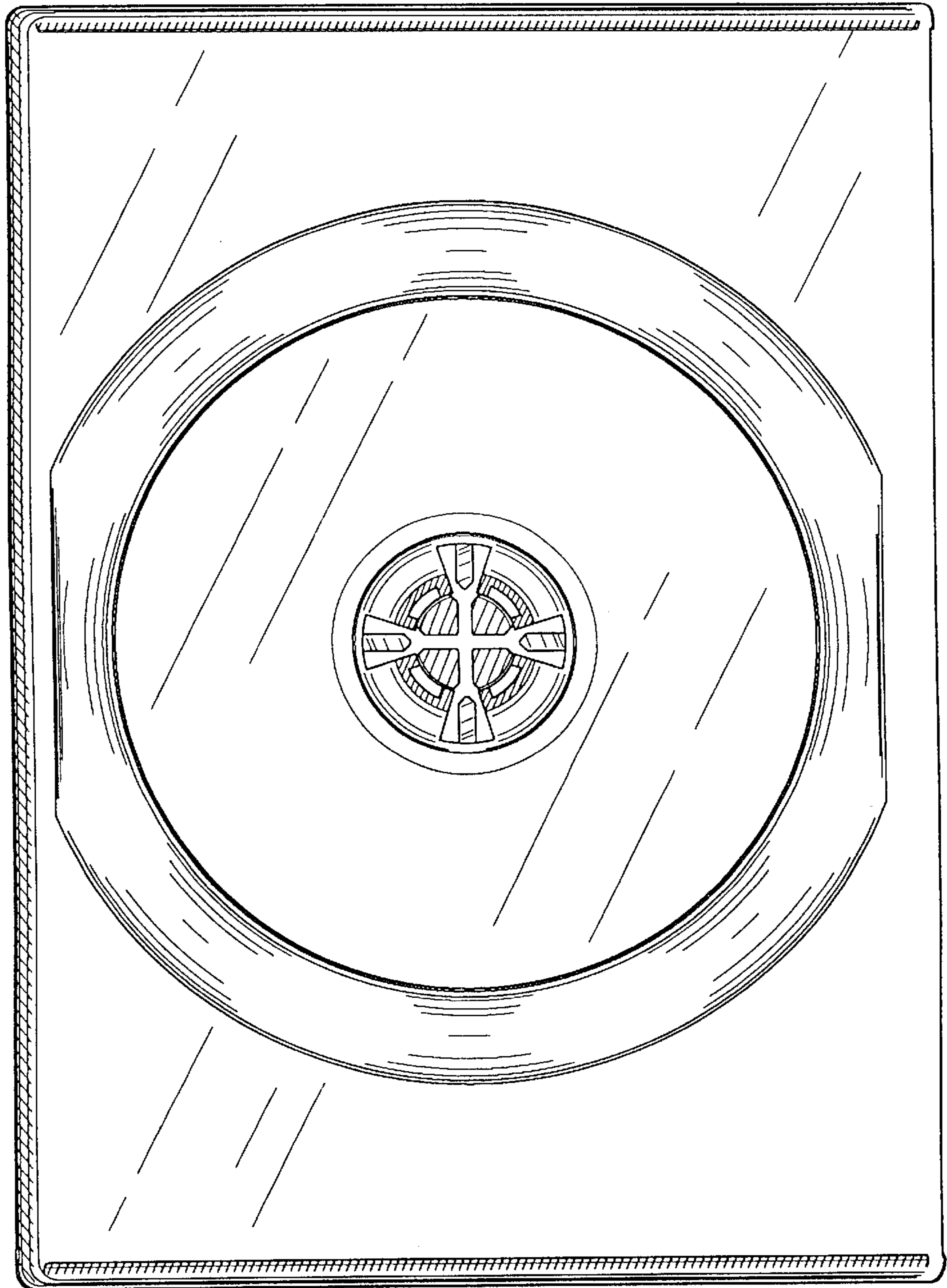

Fig. 6

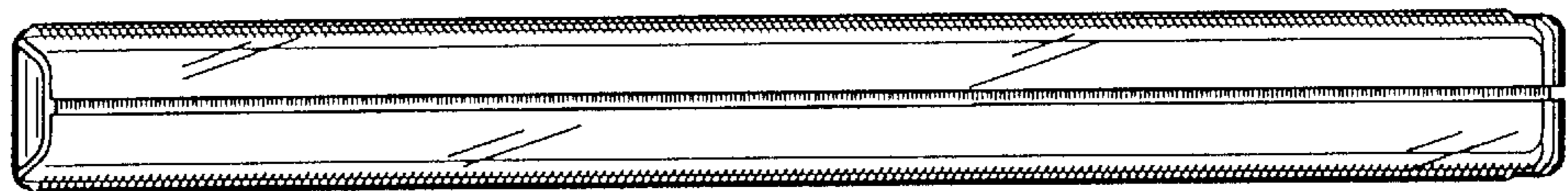

Fig. 7

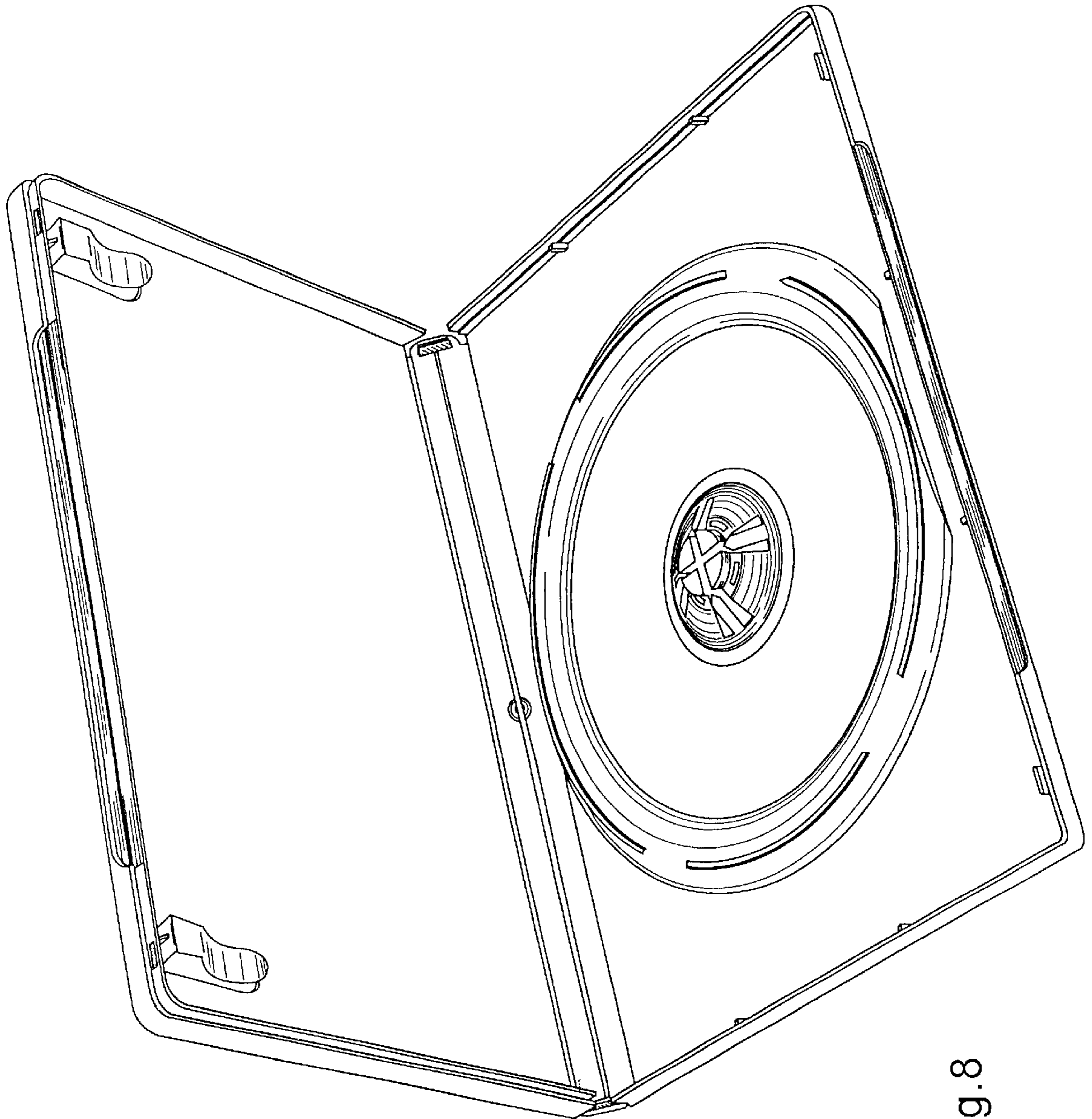

Fig. 8