



US00D465884S

(12) **United States Design Patent**
Ross

(10) **Patent No.:** **US D465,884 S**

(45) **Date of Patent:** **** Nov. 19, 2002**

(54) **FEEDING BOWL**

(75) Inventor: **Allan G. Ross**, Masury, OH (US)

(73) Assignee: **Alco Industries, Inc.**, Valley Forge, PA (US)

(**) Term: **14 Years**

(21) Appl. No.: **29/143,733**

(22) Filed: **Jun. 19, 2001**

(51) **LOC (7) Cl.** **30-03**

(52) **U.S. Cl.** **D30/129; D30/130**

(58) **Field of Search** D30/129-133,
D30/121, 122; D7/502, 505, 504, 546,
555, 556, 553.1, 553.3, 553.6; 119/61,
51.5, 74, 464

(56) **References Cited**

U.S. PATENT DOCUMENTS

- 2,677,350 A * 5/1954 Prestidge et al. 119/61
- D313,488 S * 1/1991 Conner D30/130
- 5,775,255 A * 7/1998 Louviere 119/61
- D424,757 S * 5/2000 Cooper et al. D30/129

* cited by examiner

Primary Examiner—Pamela Burgess

(74) *Attorney, Agent, or Firm*—Webb Ziesenheim Logsdon Orkin & Hanson, P.C.

(57) **CLAIM**

The ornamental design for a feeding bowl, as shown and described.

DESCRIPTION

FIG. 1 is a perspective view of a first embodiment of a feeding bowl showing my new design;
 FIG. 2 is a top plan view thereof;
 FIG. 3 is a bottom plan view thereof;
 FIG. 4 is a side elevation view thereof;
 FIG. 5 is a side elevation view thereof, taken opposite the view of FIG. 4;
 FIG. 6 is a side elevation view thereof, taken a 90° to the view of FIG. 4;
 FIG. 7 is a side elevation view thereof, taken opposite the view of FIG. 6;
 FIG. 8 is a perspective view of a second embodiment of a feeding bowl showing my new design;
 FIG. 9 is a top plan view thereof;
 FIG. 10 is a bottom plan view thereof;
 FIG. 11 is a side elevation view thereof;
 FIG. 12 is a side elevation view thereof, taken opposite the view of FIG. 11;
 FIG. 13 is a side elevation view thereof, taken at 90° to the view of FIG. 11; and,
 FIG. 14 is a side elevation view thereof, taken opposite the view of FIG. 13.

1 Claim, 10 Drawing Sheets

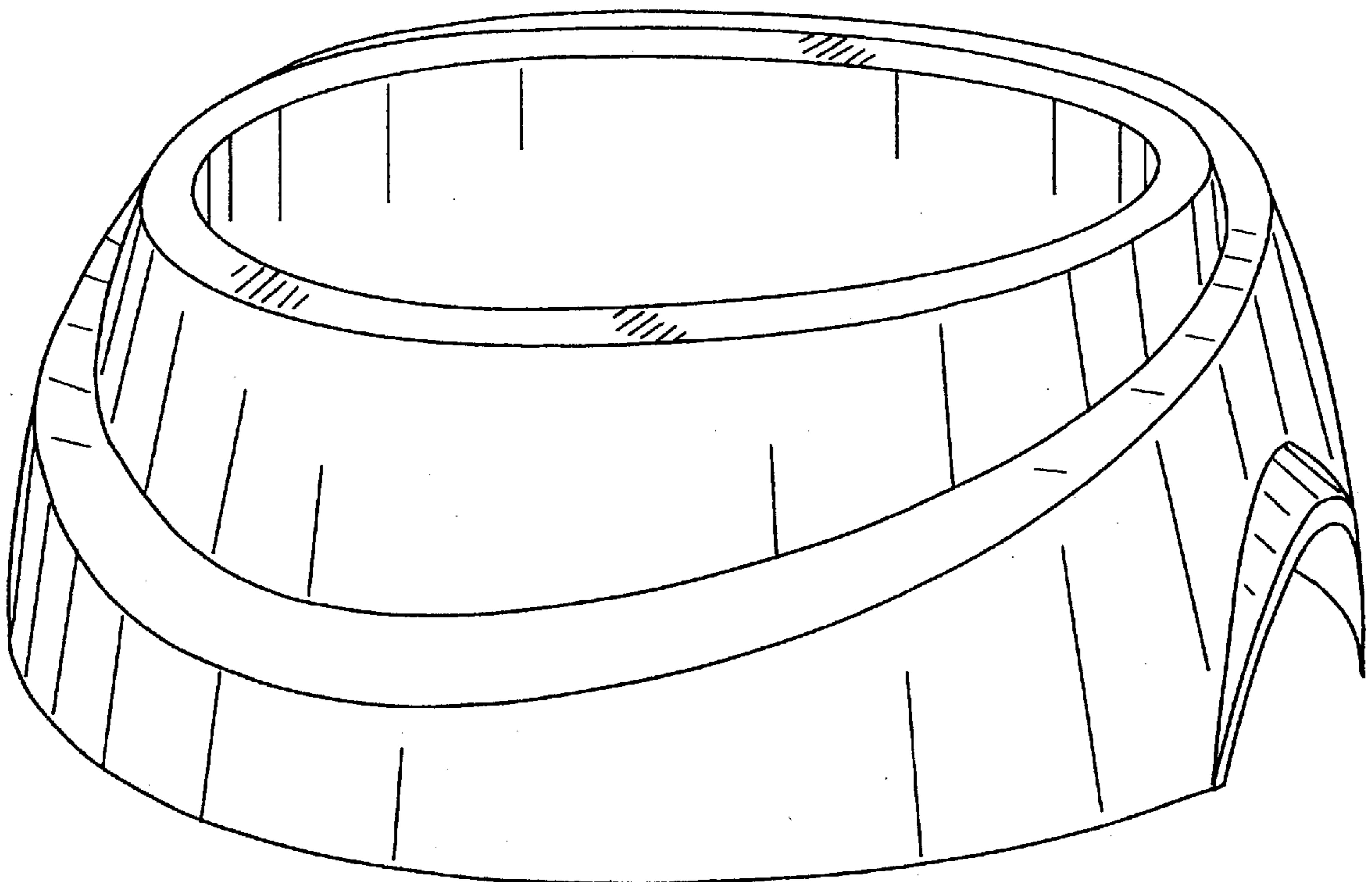

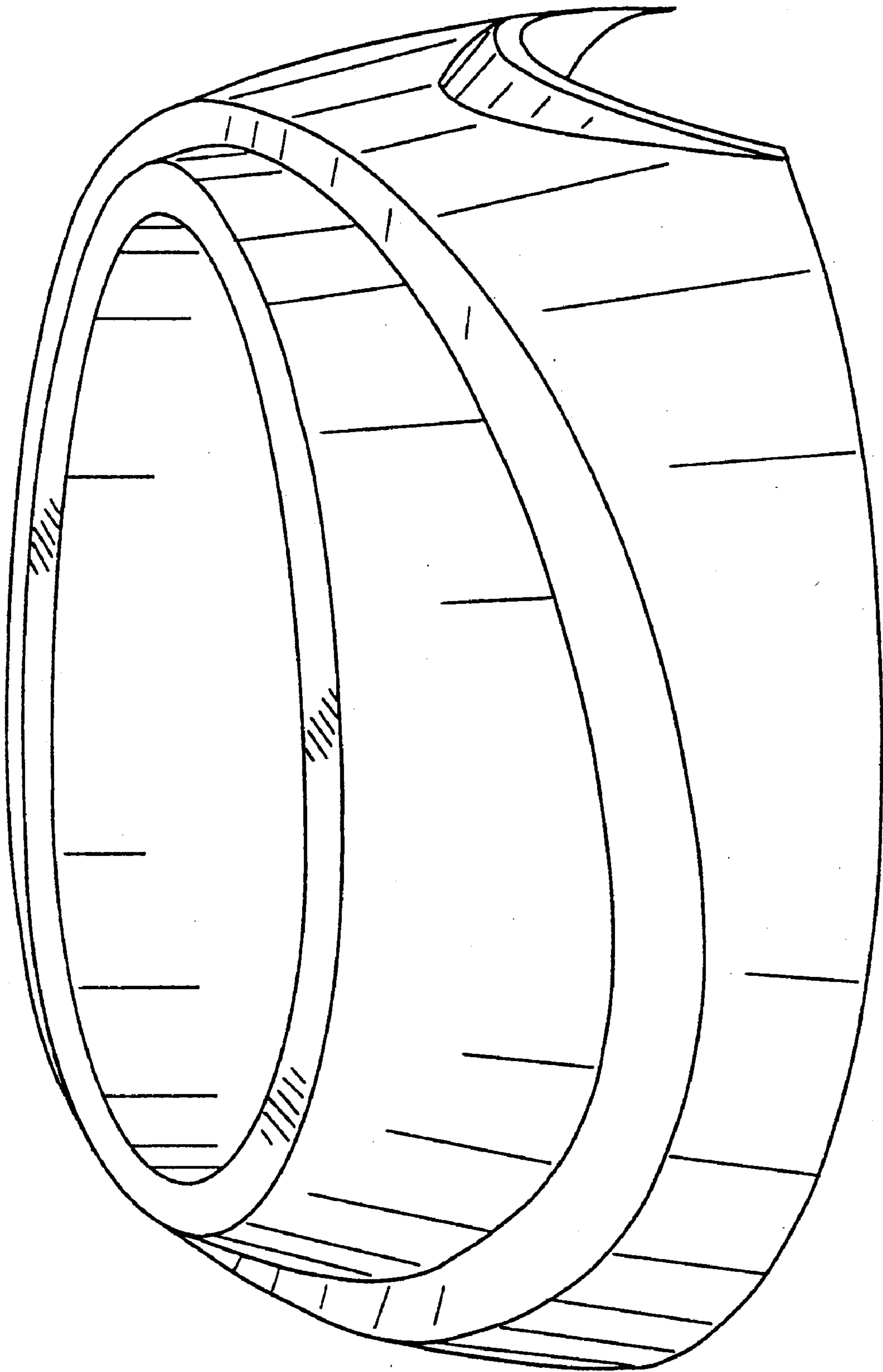

FIG. 1

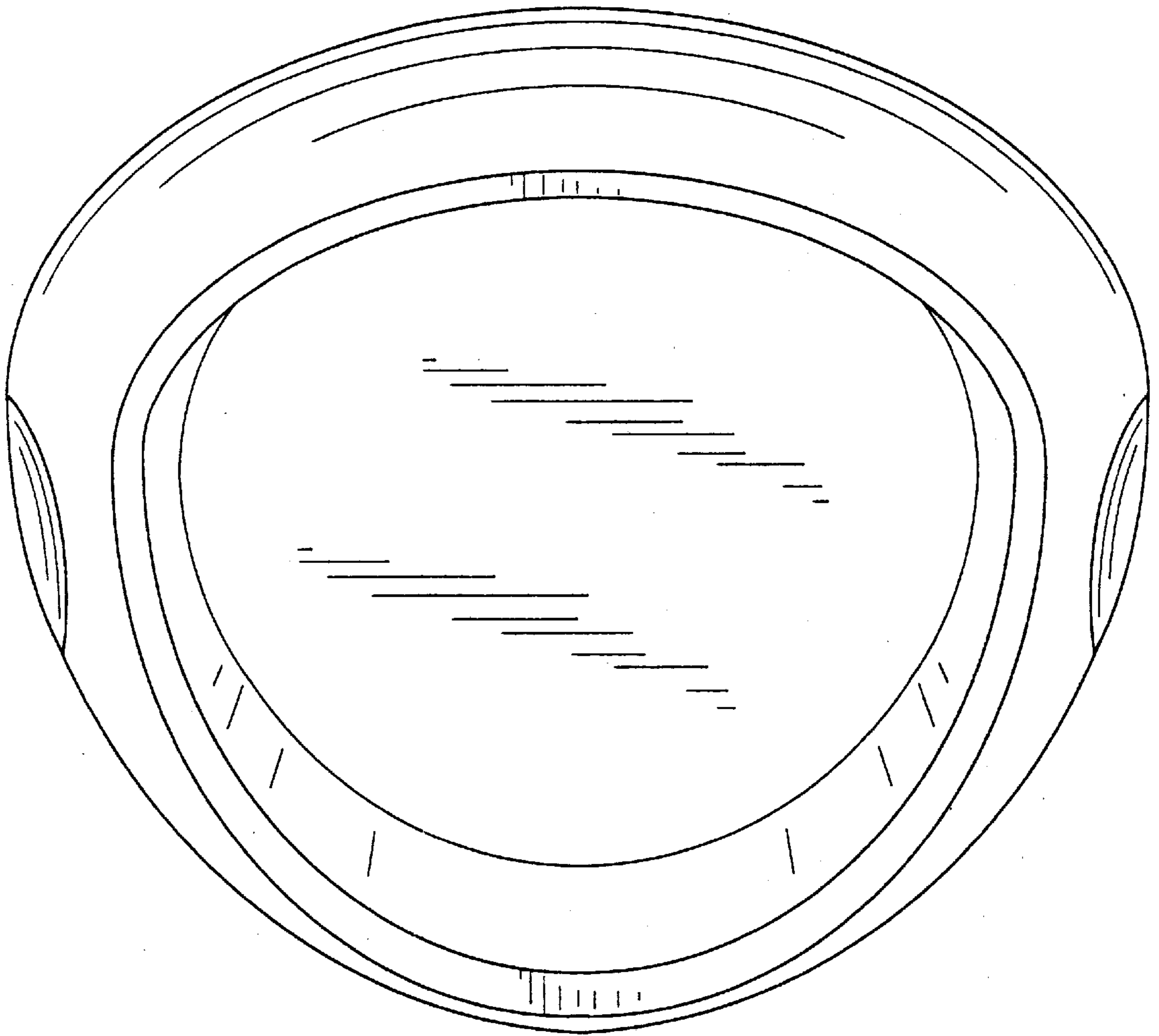

FIG. 2

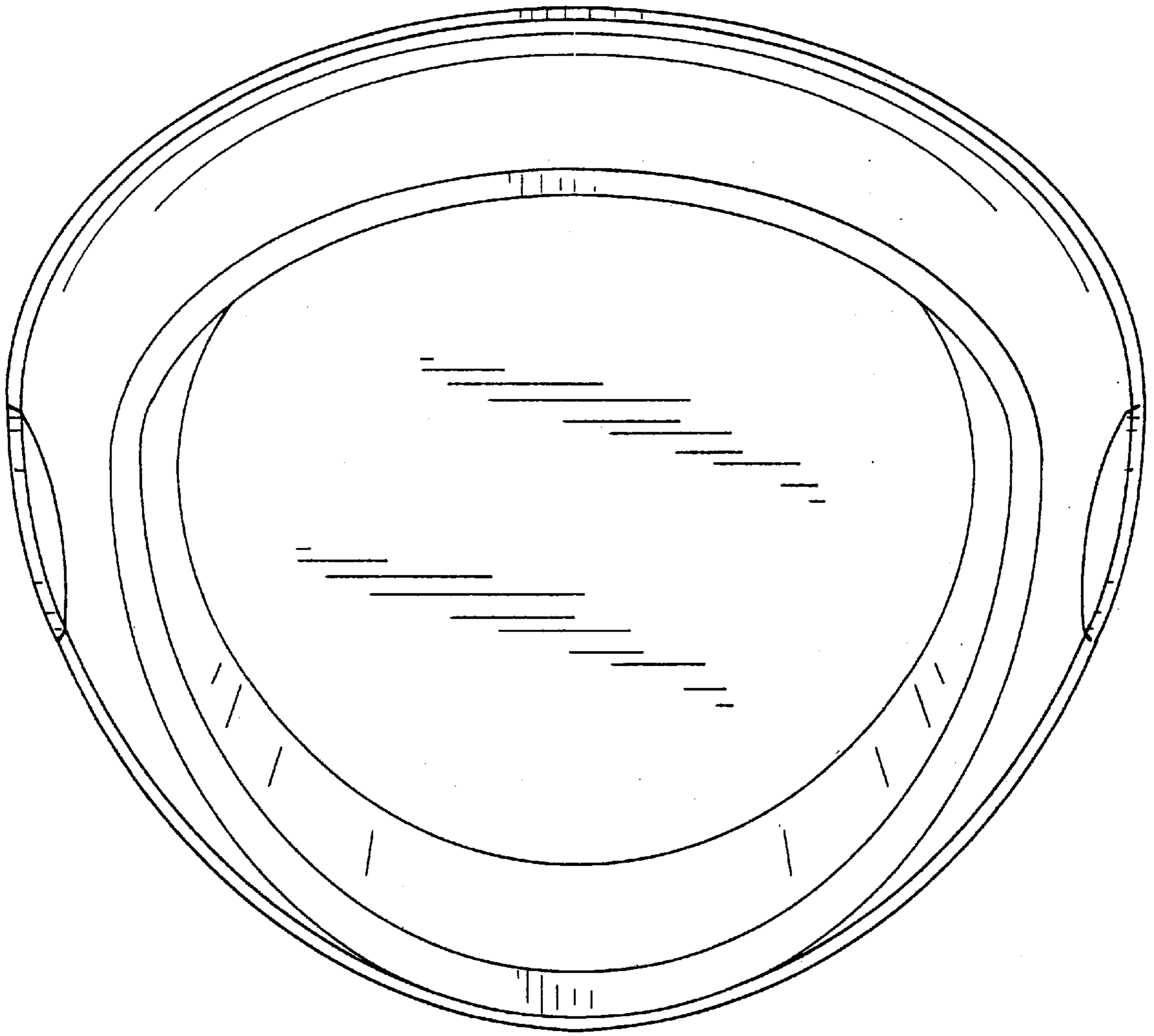

FIG. 3

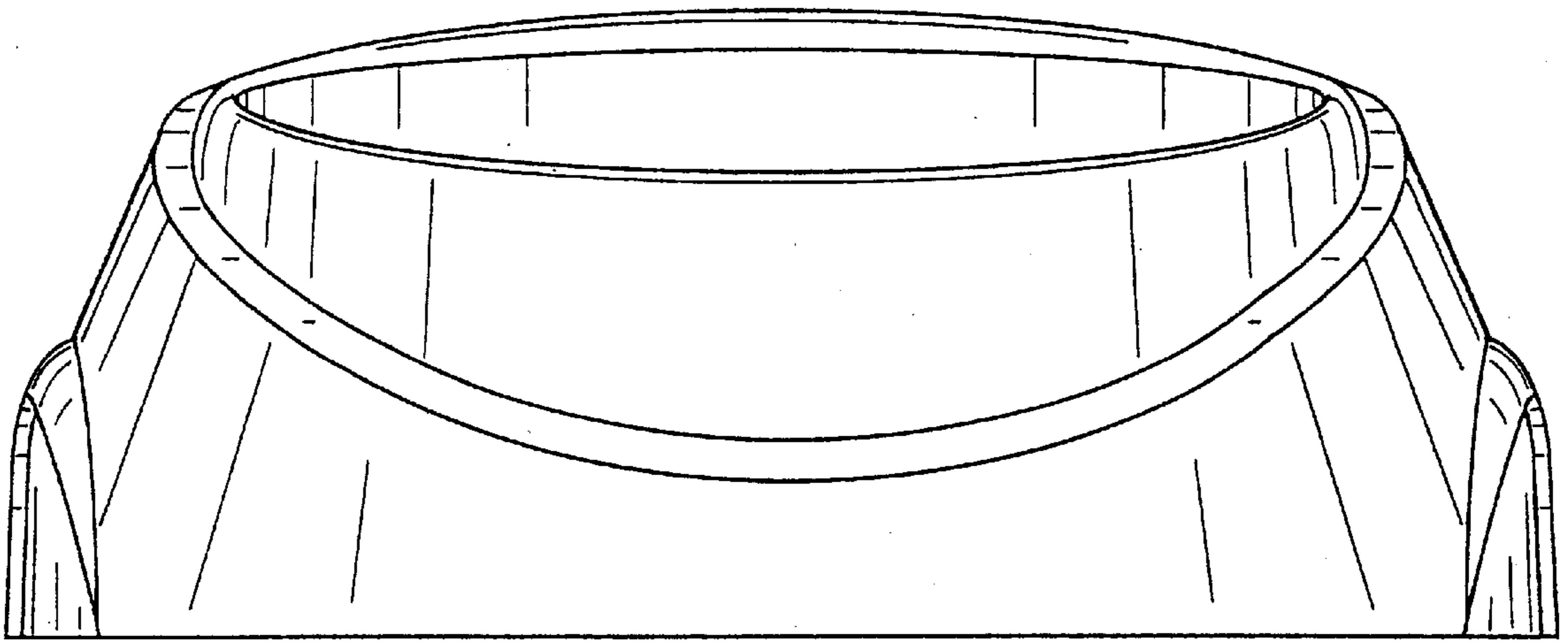

FIG. 4

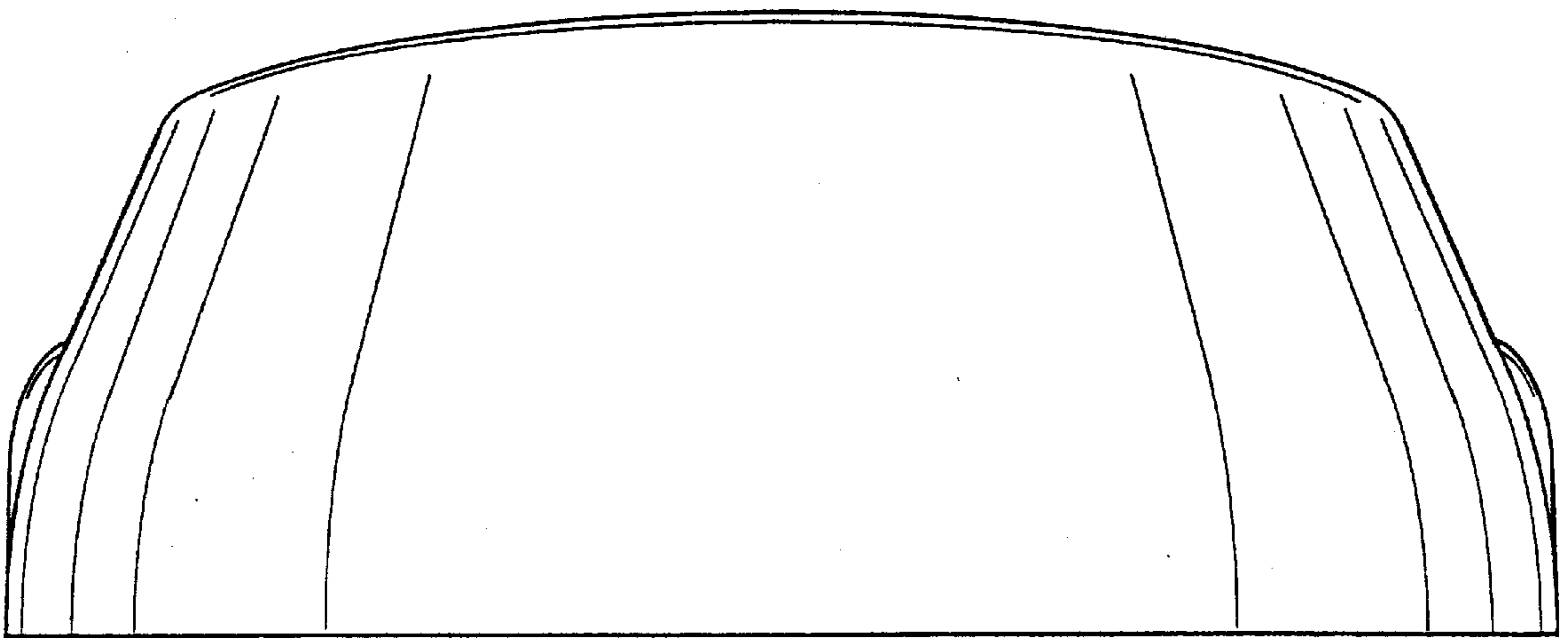

FIG. 5

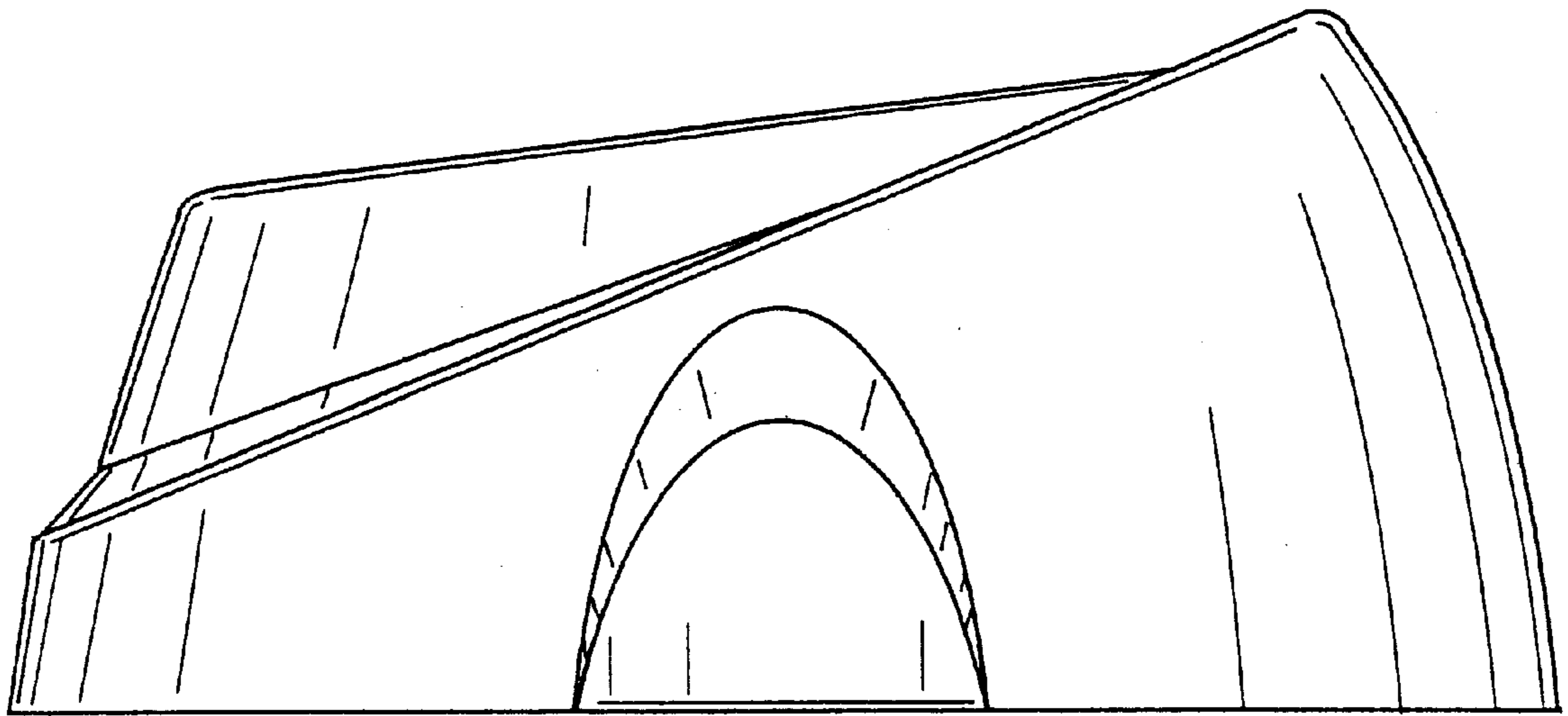

FIG. 6

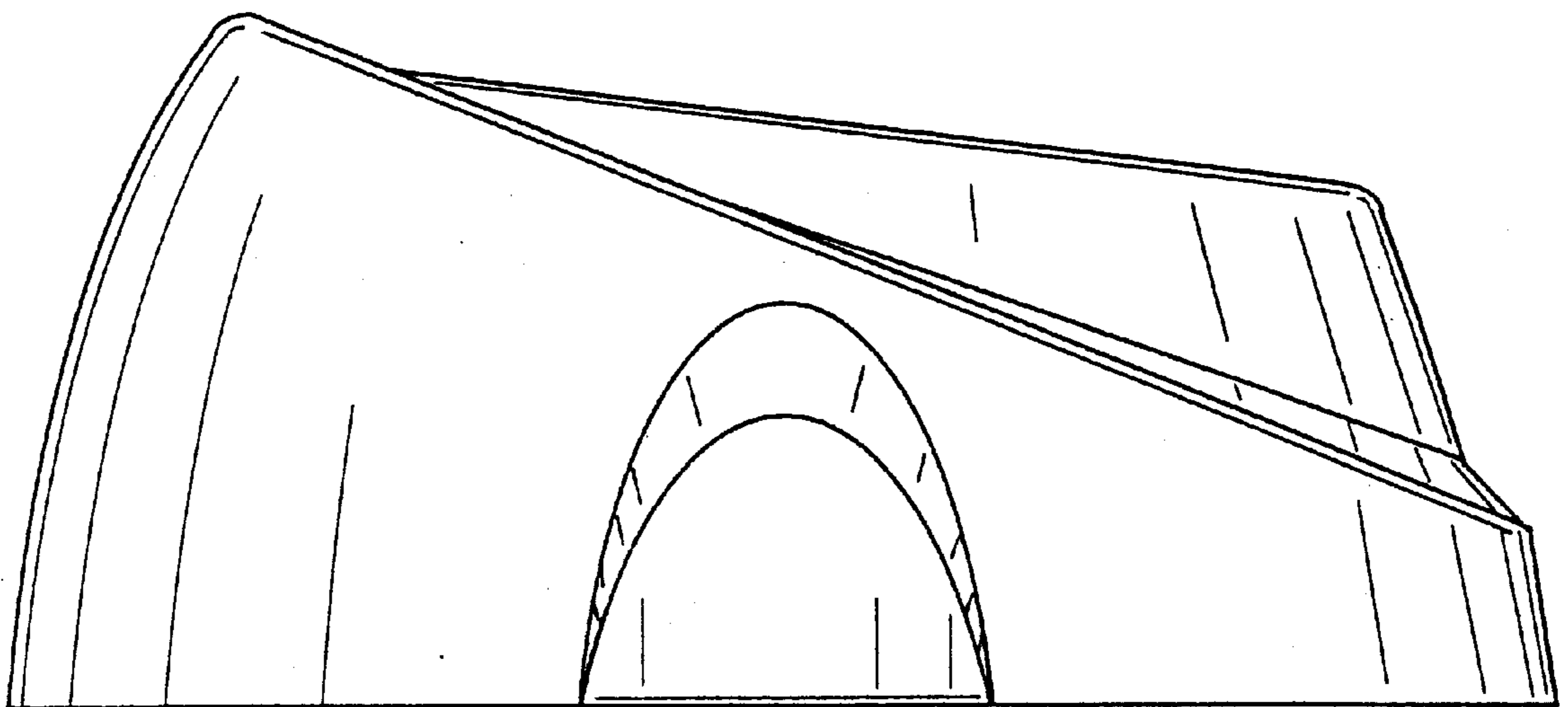

FIG. 7

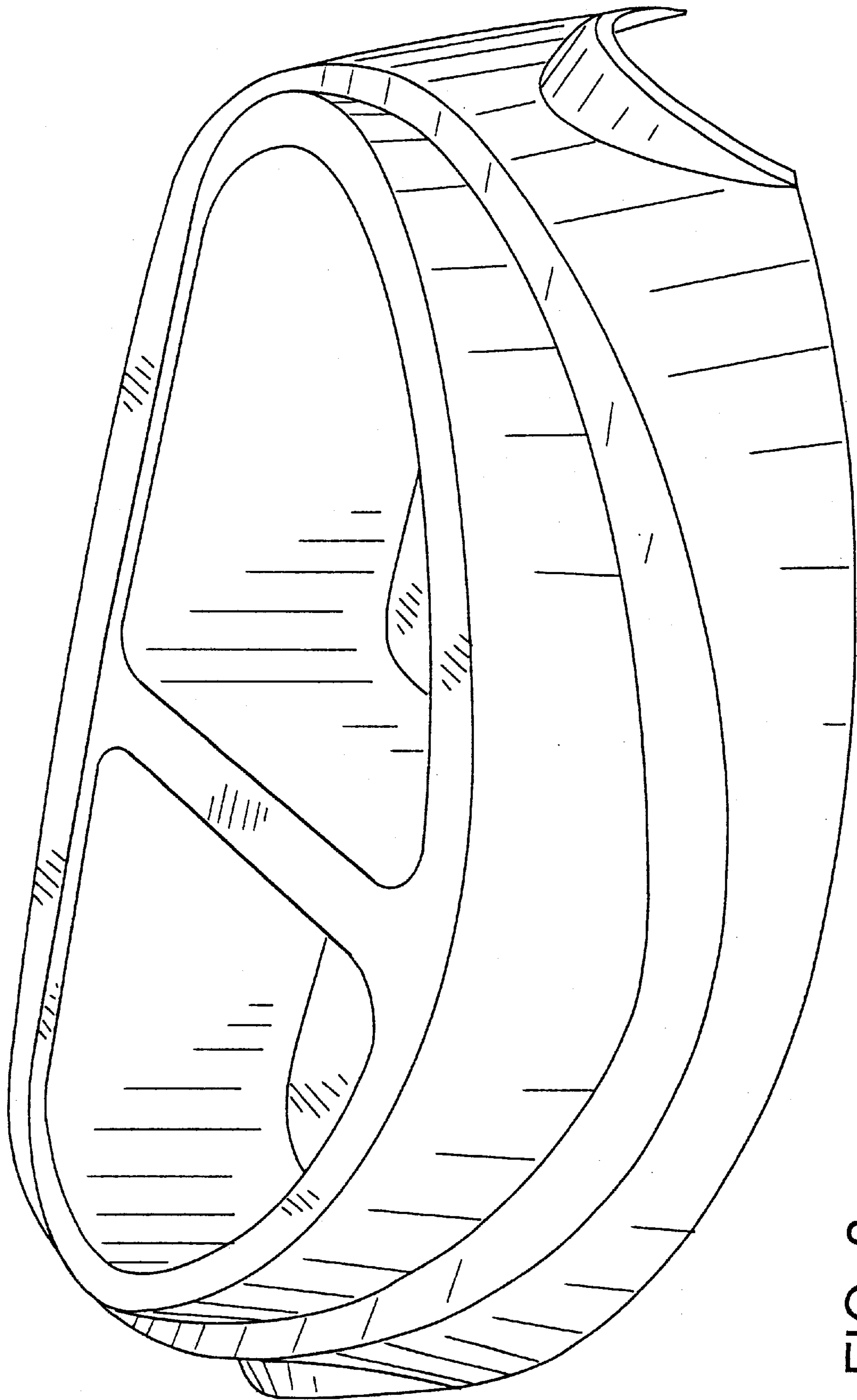

FIG. 8

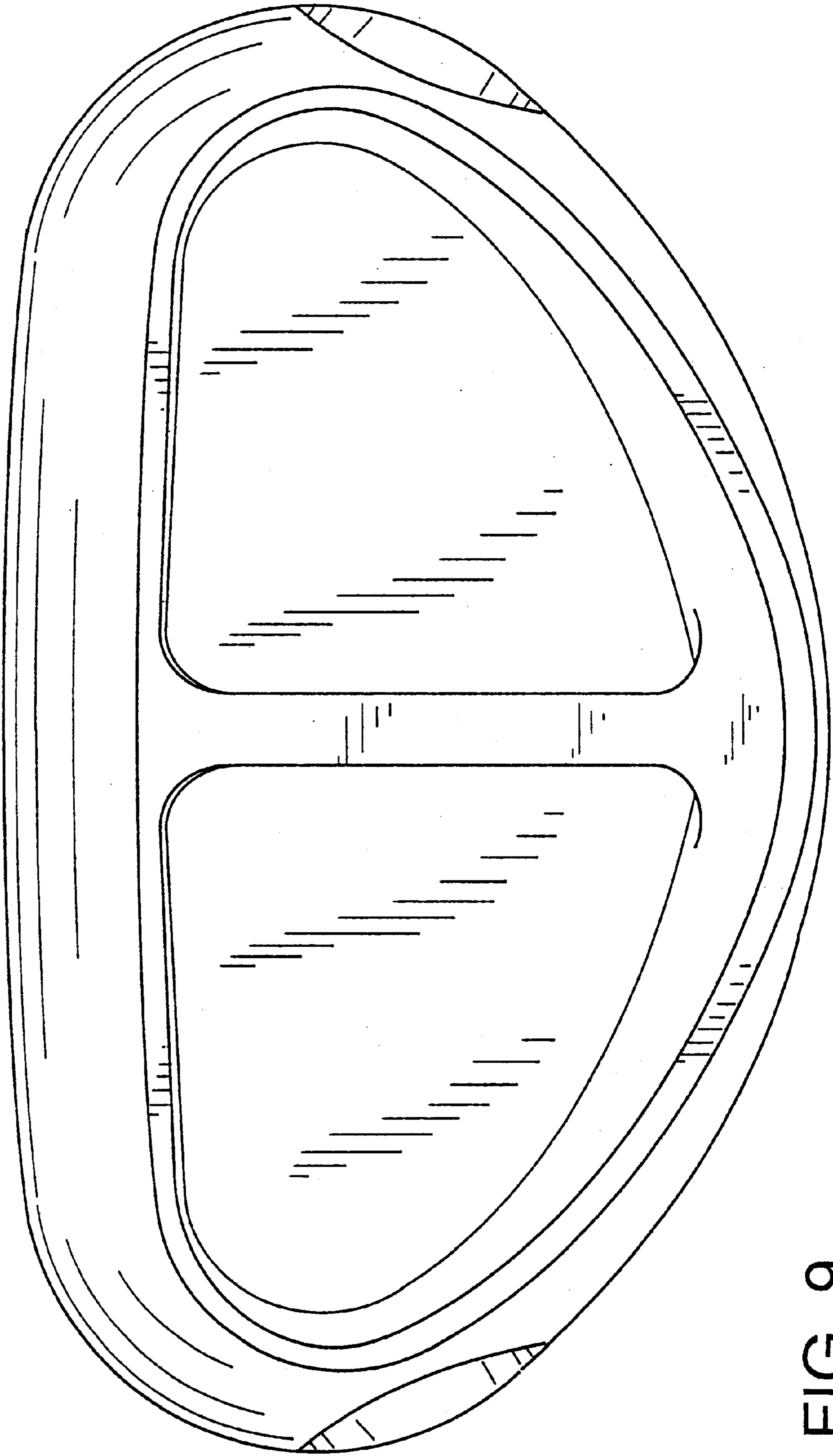

FIG. 9

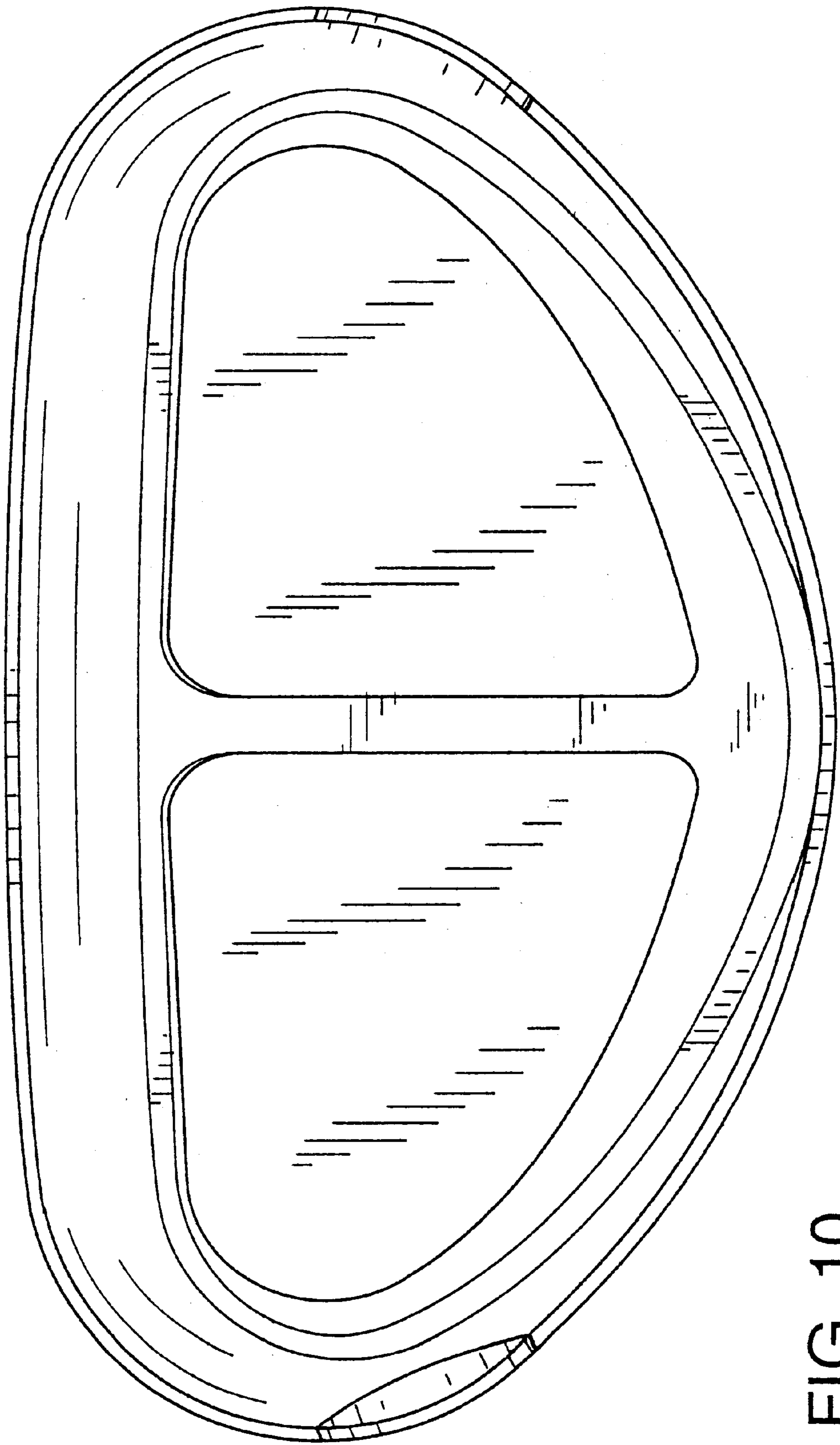

FIG. 10

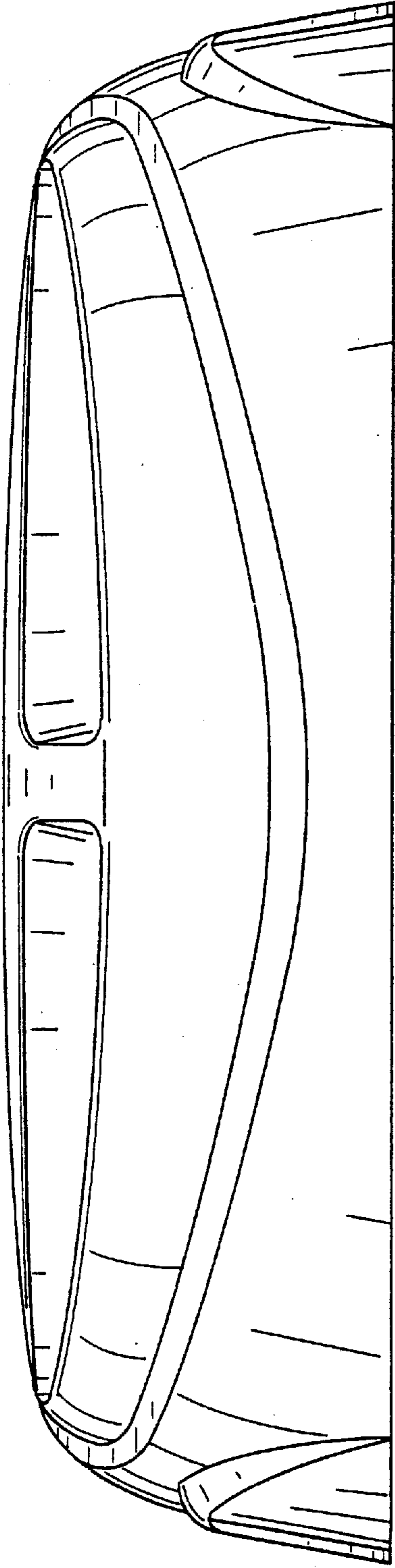

FIG. 11

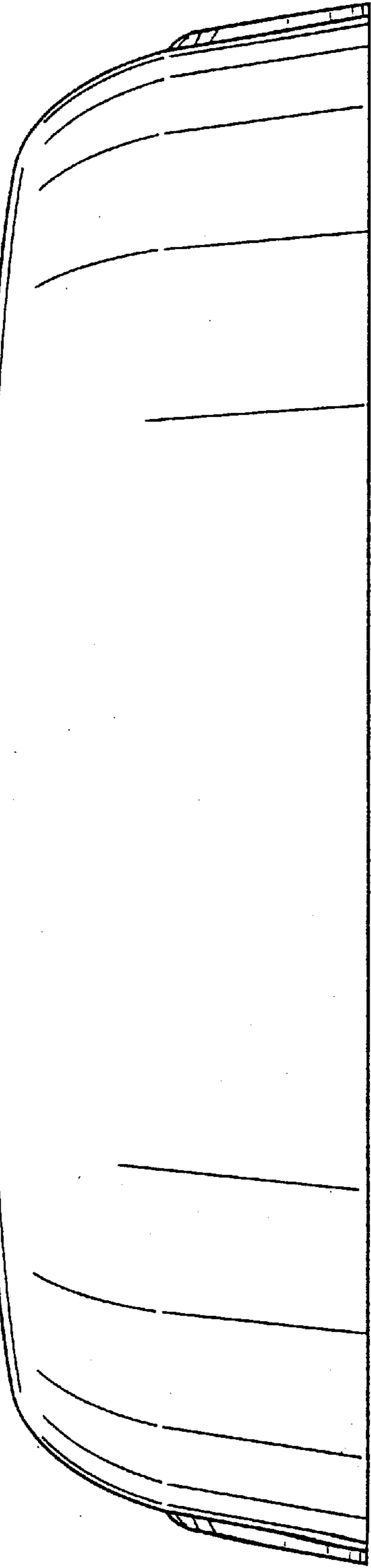

FIG. 12

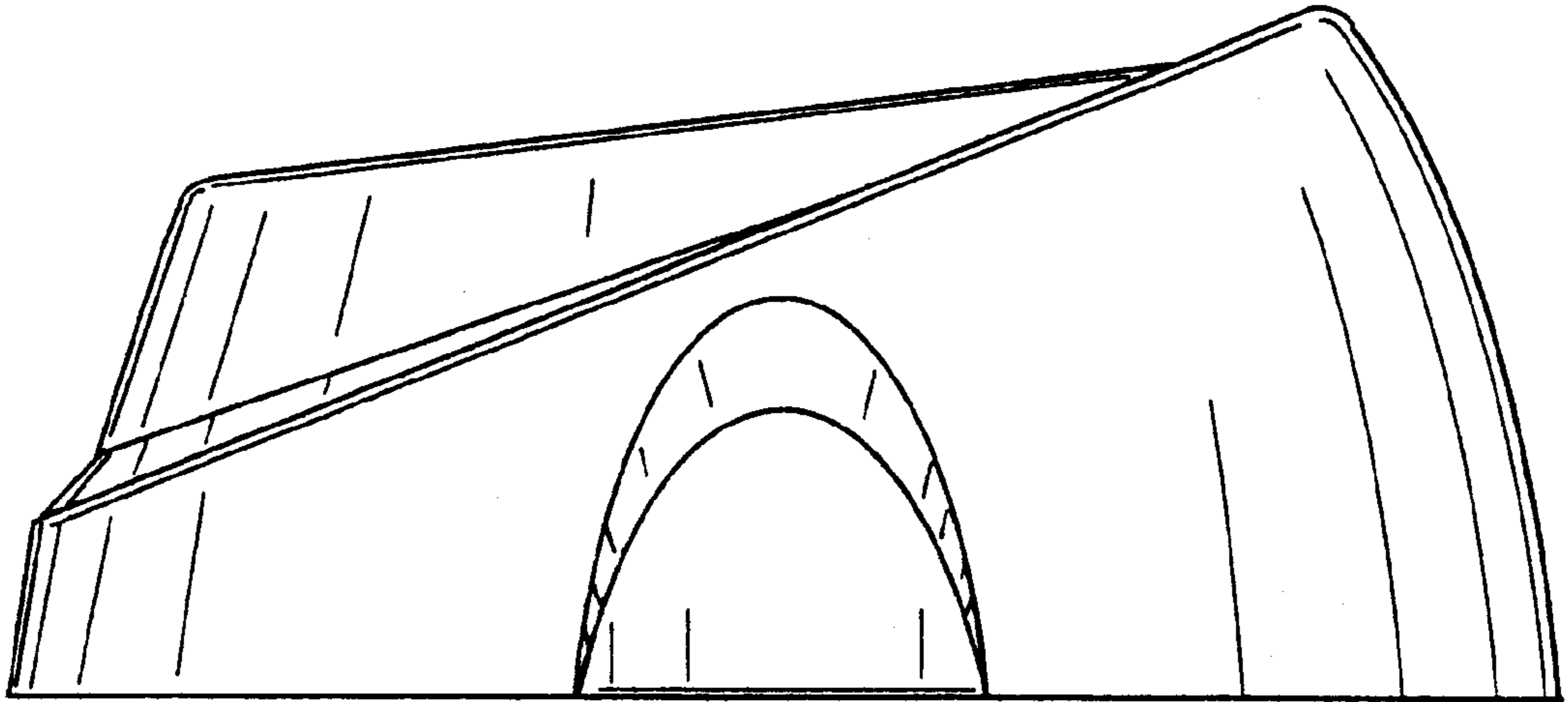

FIG. 13

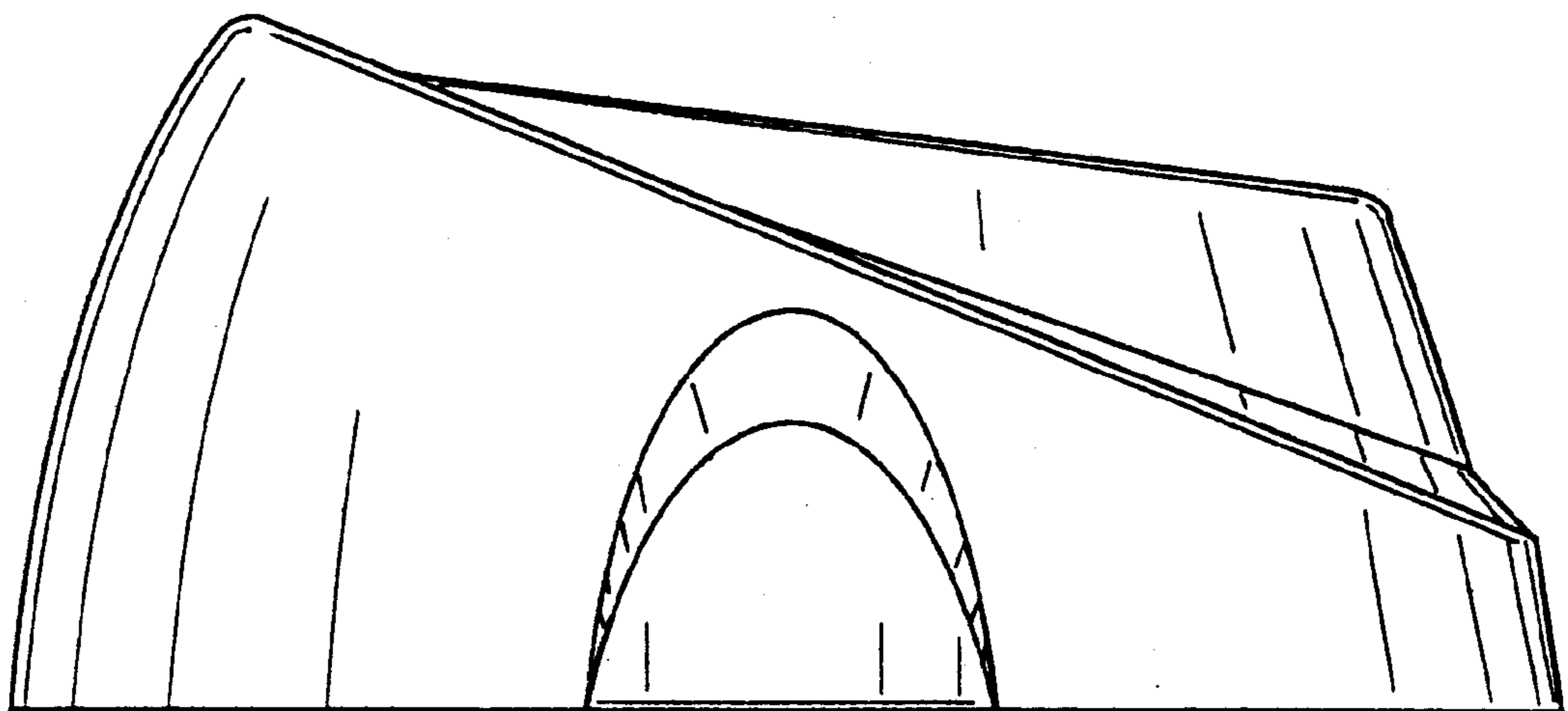

FIG. 14

UNITED STATES PATENT AND TRADEMARK OFFICE
CERTIFICATE OF CORRECTION

PATENT NO. : Des. 465,884 S
DATED : November 19, 2002
INVENTOR(S) : Allan G. Ross

Page 1 of 1

It is certified that error appears in the above-identified patent and that said Letters Patent is hereby corrected as shown below:

DESCRIPTION

Line 8, re Fig. 6, "taken a" should read -- taken at --.

Signed and Sealed this

Twenty-fifth Day of March, 2003

A handwritten signature in black ink, appearing to read "James E. Rogan", with a horizontal line drawn underneath it.

JAMES E. ROGAN
Director of the United States Patent and Trademark Office