



US00D465829S

(12) **United States Design Patent**
Singtoroj

(10) **Patent No.:** **US D465,829 S**

(45) **Date of Patent:** **** Nov. 19, 2002**

(54) **FAUCET**

(75) **Inventor:** **Yos Singtoroj, Anaheim, CA (US)**

(73) **Assignee:** **Emhart LLC, Newark, DE (US)**

(**) **Term:** **14 Years**

(21) **Appl. No.:** **29/145,724**

(22) **Filed:** **Jul. 27, 2001**

(51) **LOC (7) Cl. 23-01**

(52) **U.S. Cl. D23/238**

(58) **Field of Search D23/238-257;**
4/675-678; 137/801

(56) **References Cited**

U.S. PATENT DOCUMENTS

D291,236 S * 8/1987 Delepine D23/242
D393,692 S * 4/1998 Ko D23/238

D421,642 S * 3/2000 Ko D23/255

* cited by examiner

Primary Examiner—Louis S. Zarfes

Assistant Examiner—Gregory Andoll

(74) *Attorney, Agent, or Firm*—Richard J. Veltman; John D. Del Ponti

(57) **CLAIM**

The ornamental design for a faucet, as shown and described.

DESCRIPTION

FIG. 1 is a perspective view of the new design for a faucet; FIG. 2 is a front elevational view of the new design for a faucet; FIG. 3 is a rear elevational view of the new design for a faucet; FIG. 4 is a right side elevational view of the new design for a faucet, the left side elevational view being a mirror image; FIG. 5 is a top plan view of the new design for a faucet; and, FIG. 6 is a bottom plan view of the new design for a faucet.

1 Claim, 6 Drawing Sheets

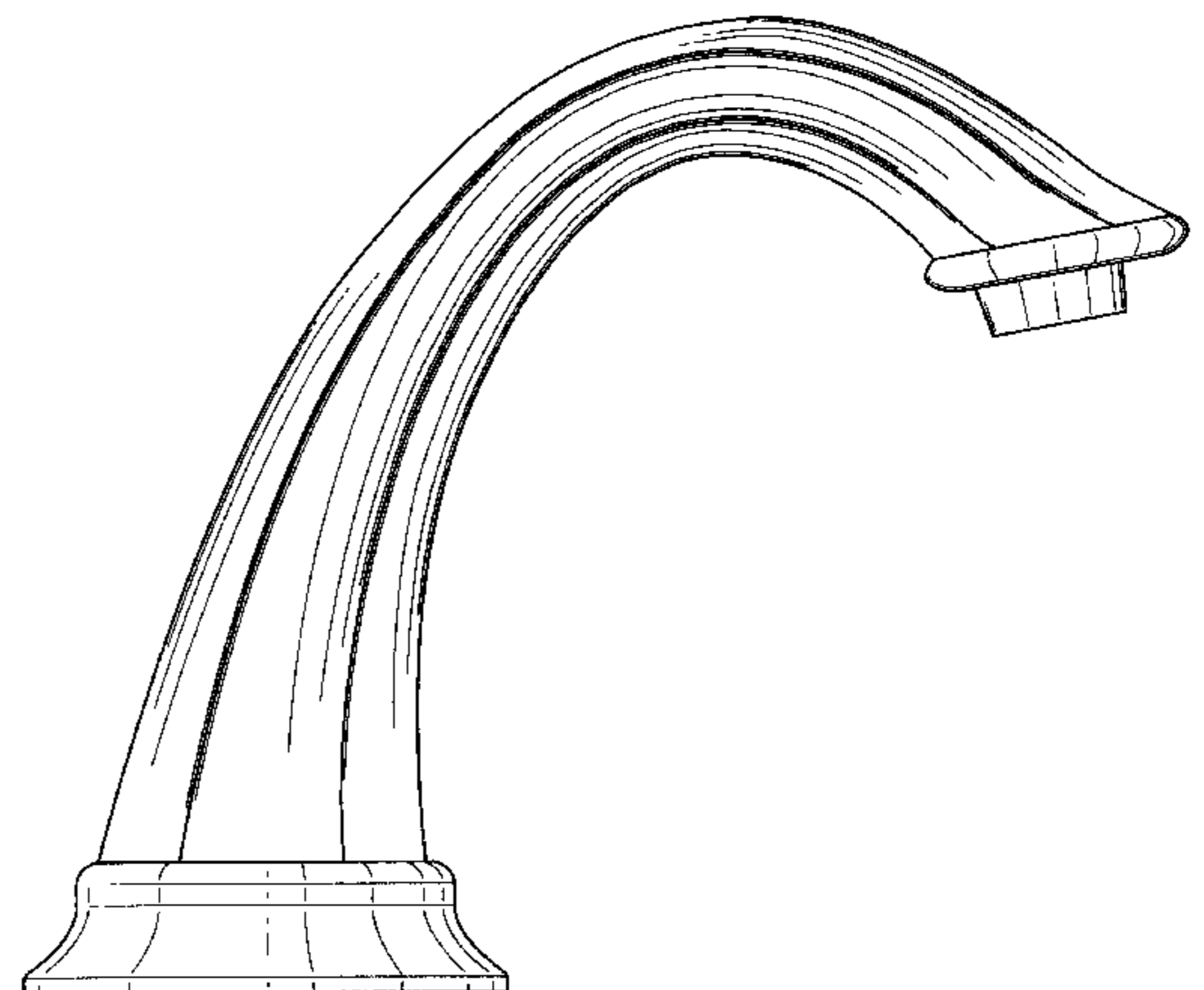
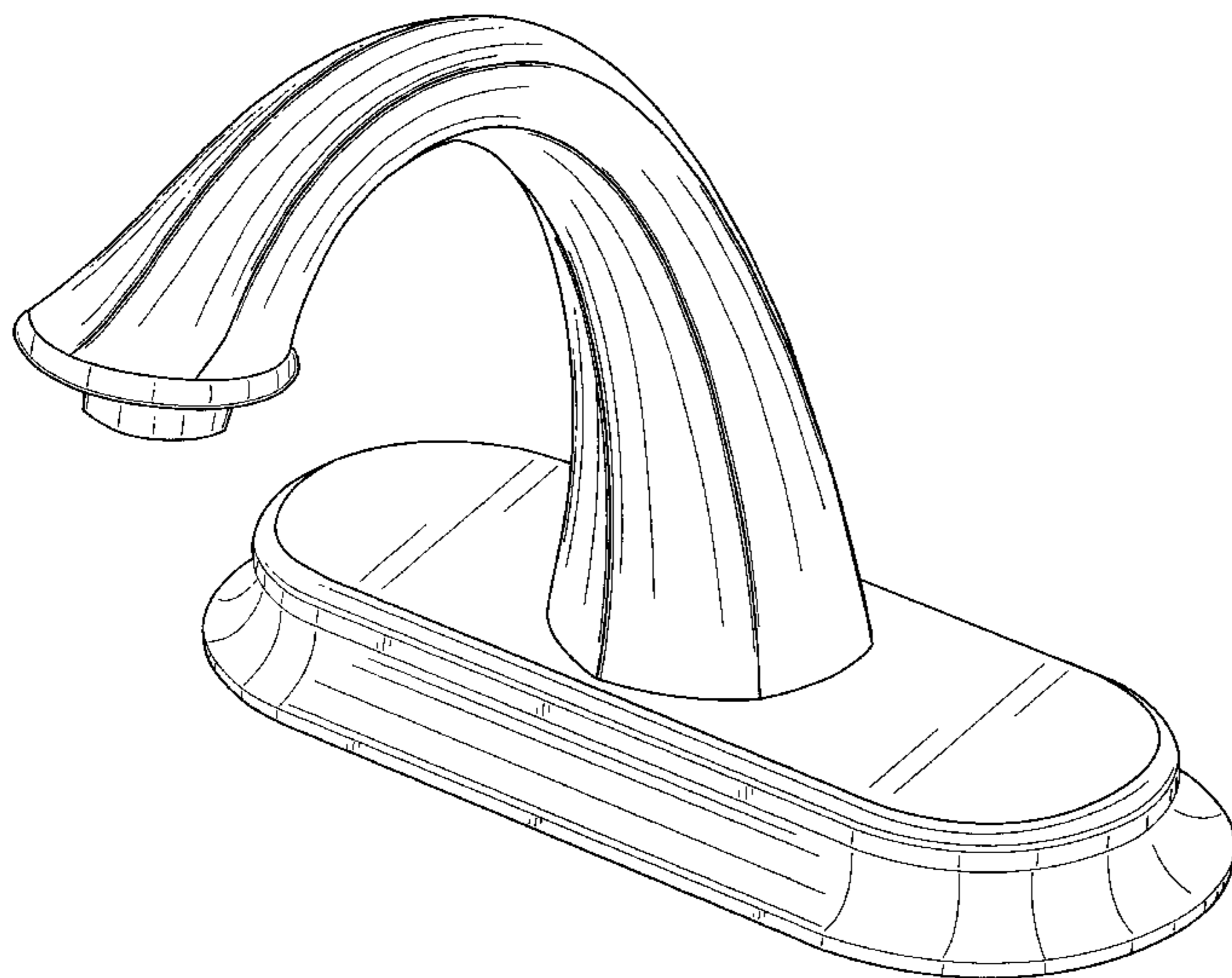

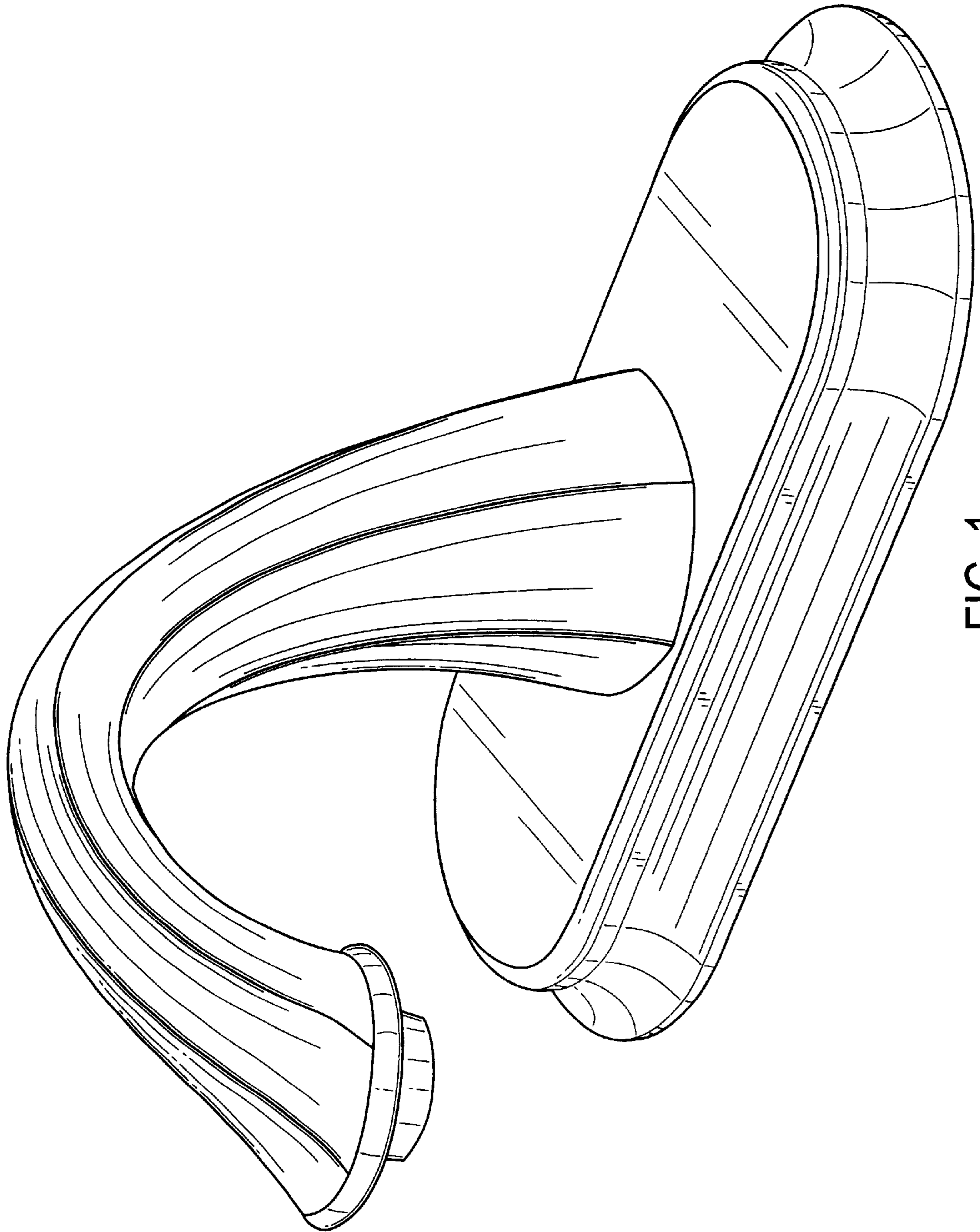

FIG. 1

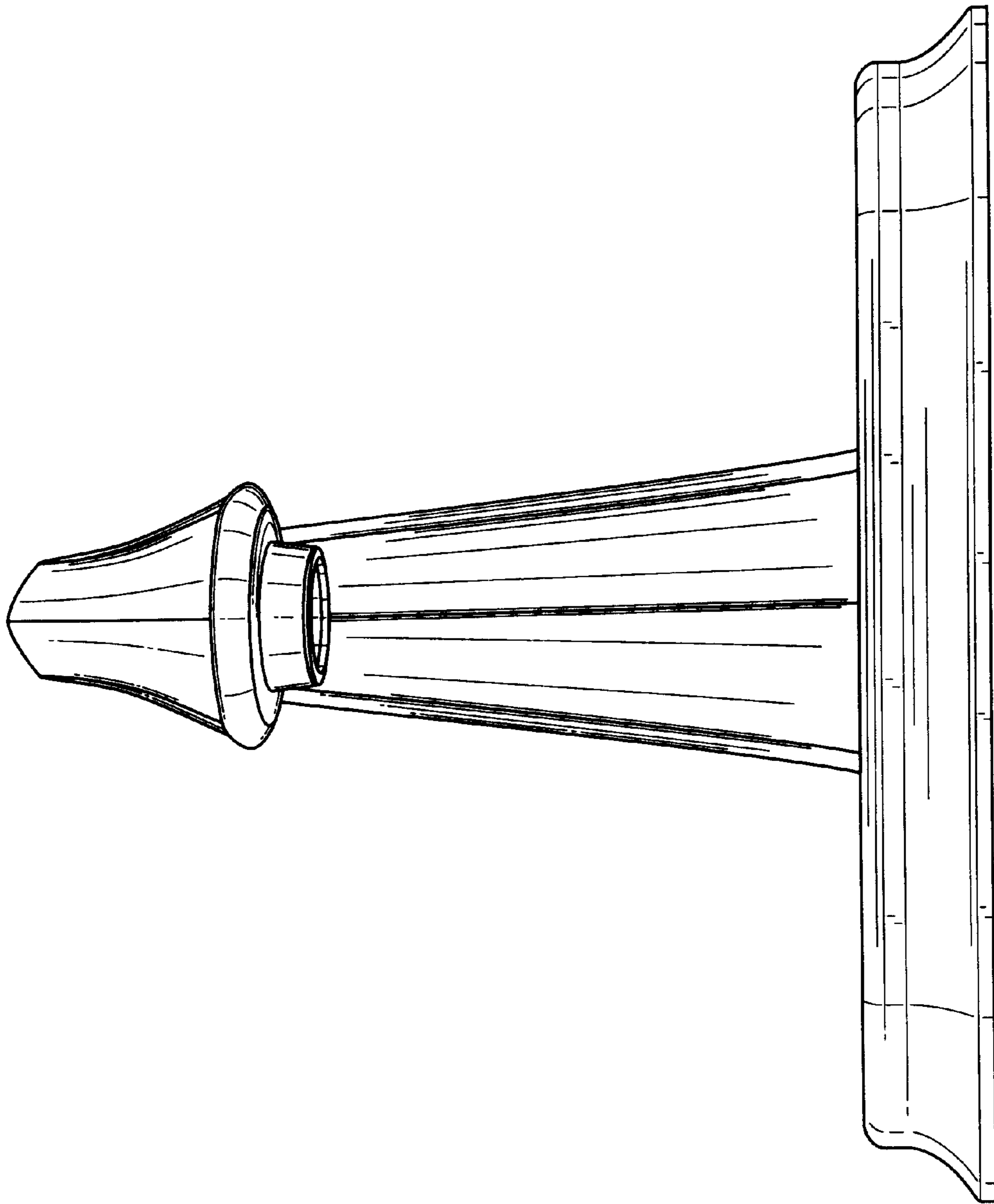

FIG. 2

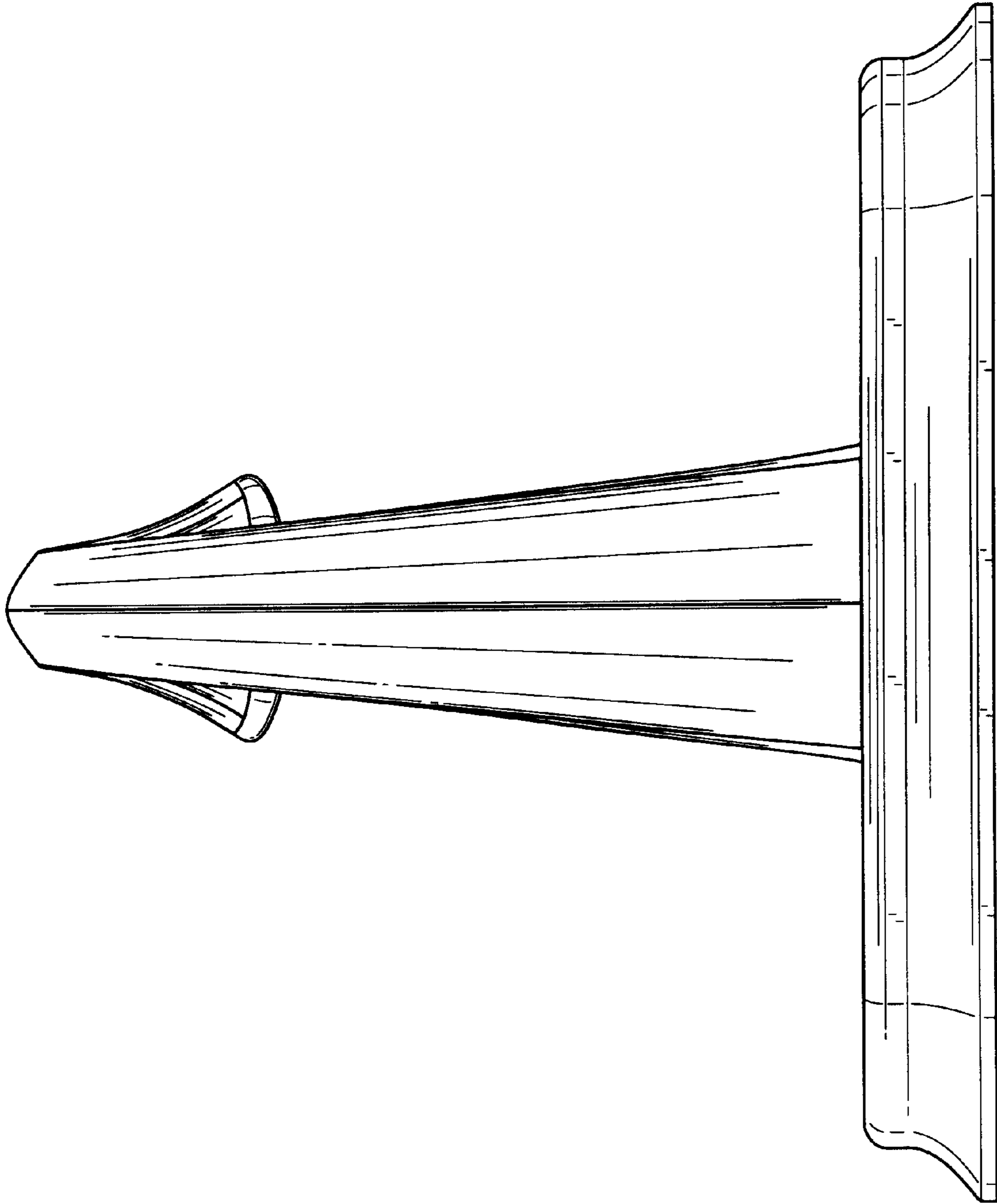

FIG. 3

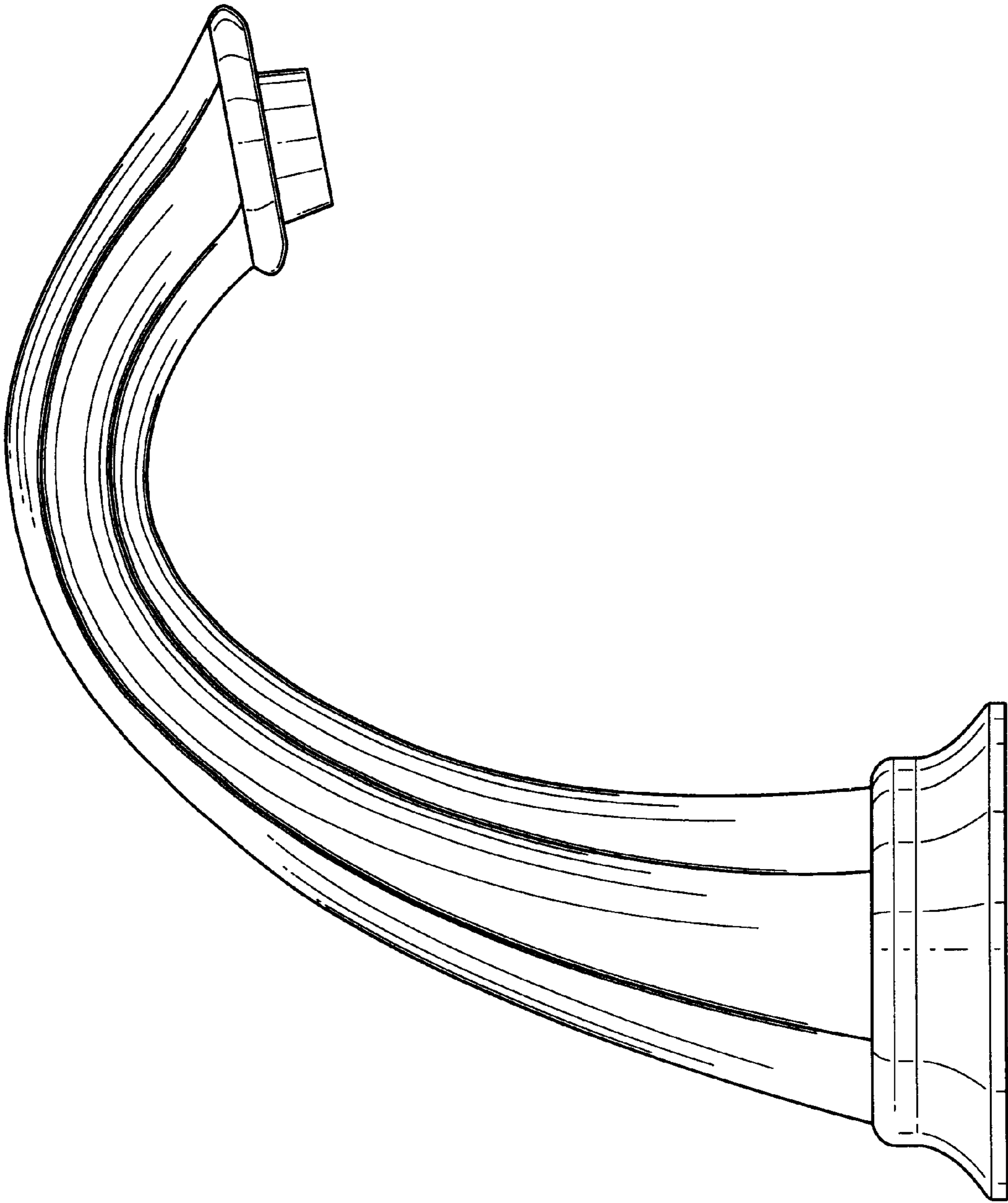

FIG. 4

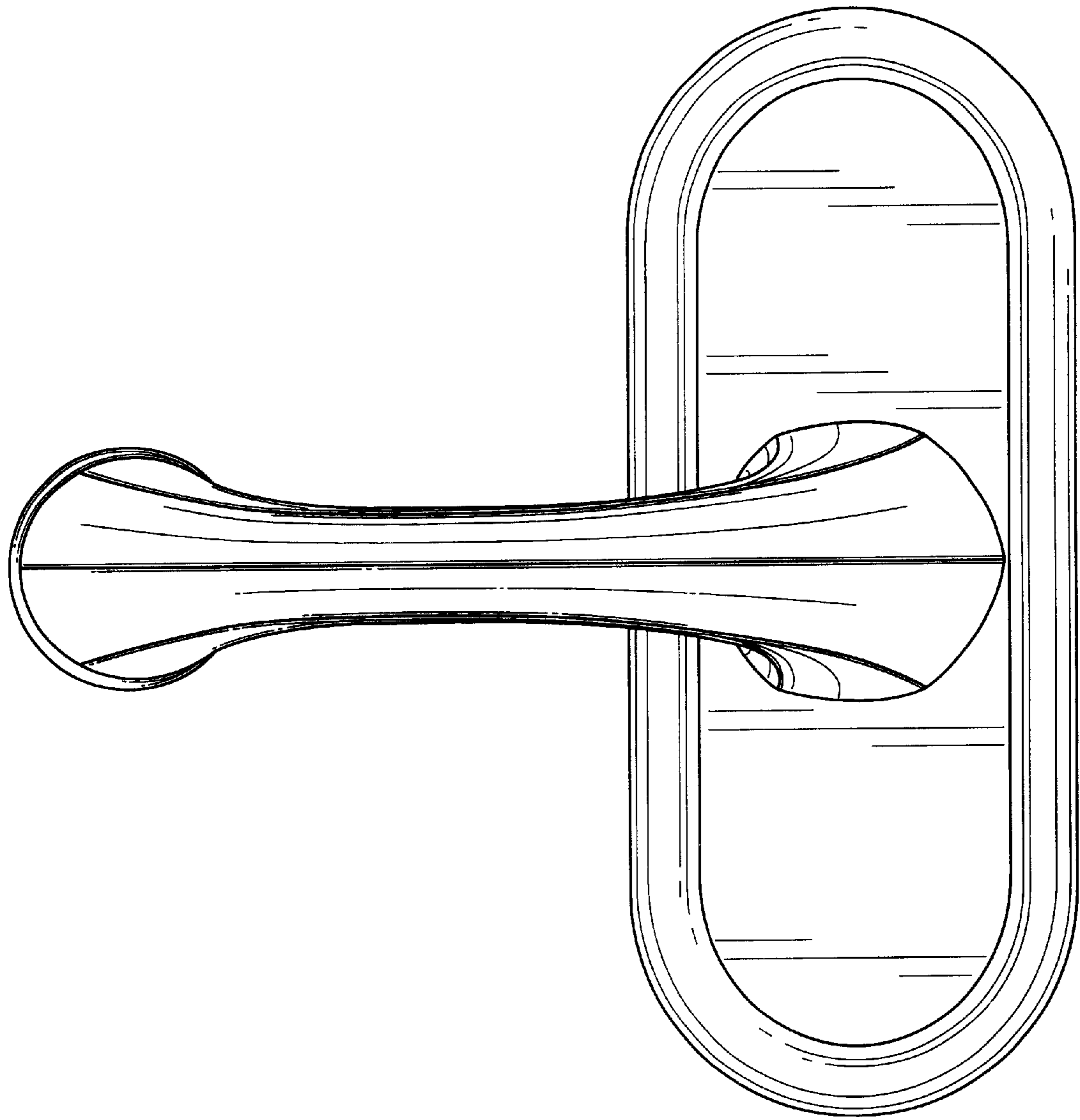

FIG. 5

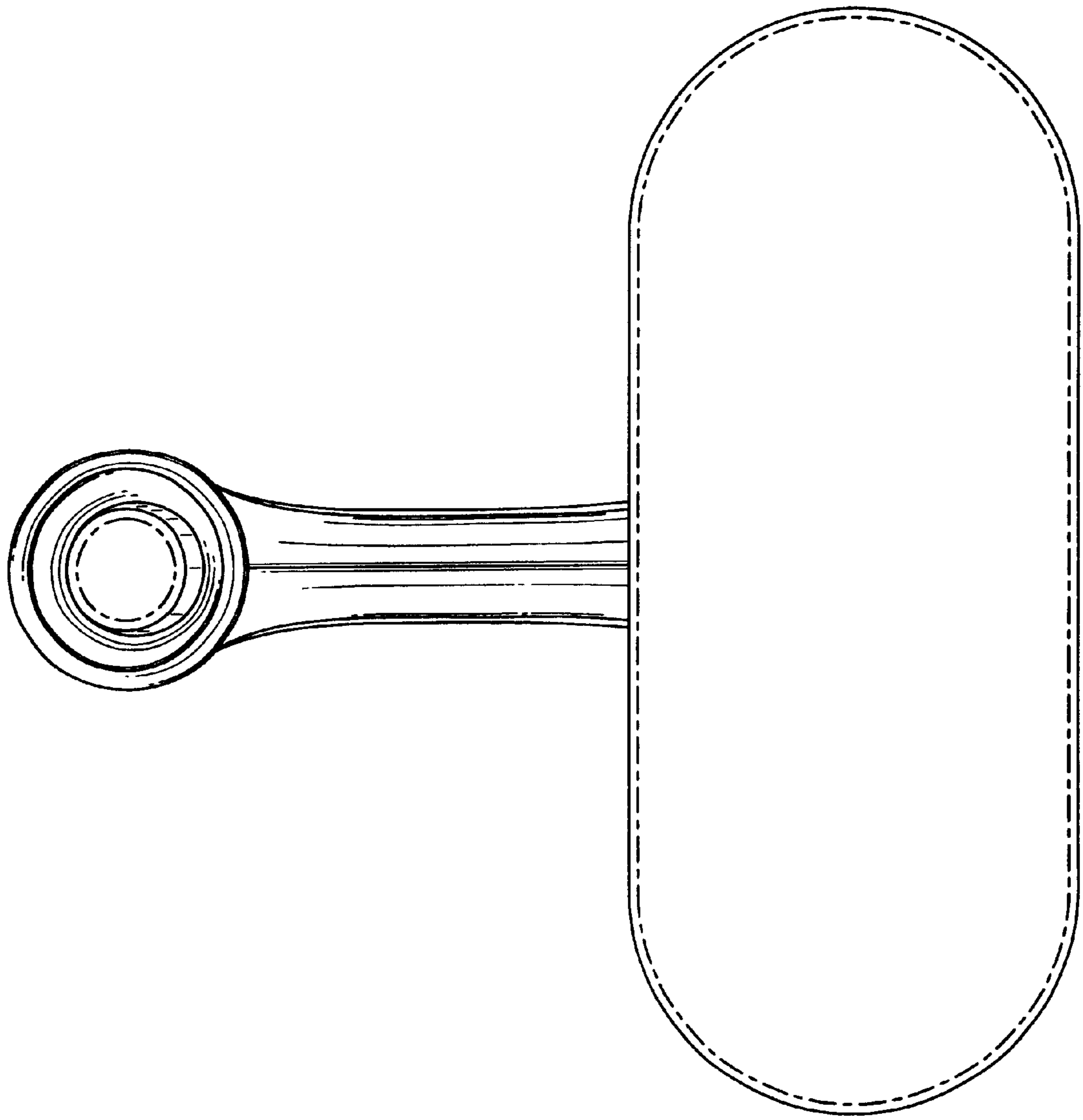

FIG. 6