



US00D465804S

(12) **United States Design Patent**
Matsumoto et al.

(10) **Patent No.:** **US D465,804 S**

(45) **Date of Patent:** **** Nov. 19, 2002**

(54) **INK TANK HOLDER WITH PRINTING HEAD**

(75) Inventors: **Hidehisa Matsumoto, Kawasaki (JP); Ken Hosaka, Yokohoma (JP)**

(73) Assignee: **Canon Kabushiki Kaisha, Tokyo (JP)**

(**) Term: **14 Years**

(21) Appl. No.: **29/151,706**

(22) Filed: **Dec. 11, 2001**

(30) **Foreign Application Priority Data**

Jun. 15, 2001 (JP) 2001-017540

(51) **LOC (7) Cl.** **18-02**

(52) **U.S. Cl.** **D18/56; 347/86**

(58) **Field of Search** **D18/56, 43; 347/86, 347/87**

(56) **References Cited**

U.S. PATENT DOCUMENTS

5,392,063 A * 2/1995 Rhoads 347/86
D371,804 S * 7/1996 Kotaki et al. D18/56

D382,013 S * 8/1997 Tashiro et al. D18/56
D392,672 S * 3/1998 Inoue et al. D18/56
6,050,667 A * 4/2000 Yamada 347/86
D438,242 S * 2/2001 Chiba et al. D18/56
D447,514 S * 9/2001 Takanaoka et al. D18/56

* cited by examiner

Primary Examiner—Cathy Anne MacCormac

(74) *Attorney, Agent, or Firm*—Fitzpatrick, Cella, Harper & Scinto

(57) **CLAIM**

The ornamental design for an ink tank holder with printing head, as shown and described.

DESCRIPTION

FIG. 1 is a front view of an ink tank holder with printing head showing our new design;
FIG. 2 is a rear view thereof;
FIG. 3 is a top plan view thereof;
FIG. 4 is a bottom plan view thereof;
FIG. 5 is a left side view thereof;
FIG. 6 is a right side view thereof; and,
FIG. 7 is a perspective view thereof.

1 Claim, 4 Drawing Sheets

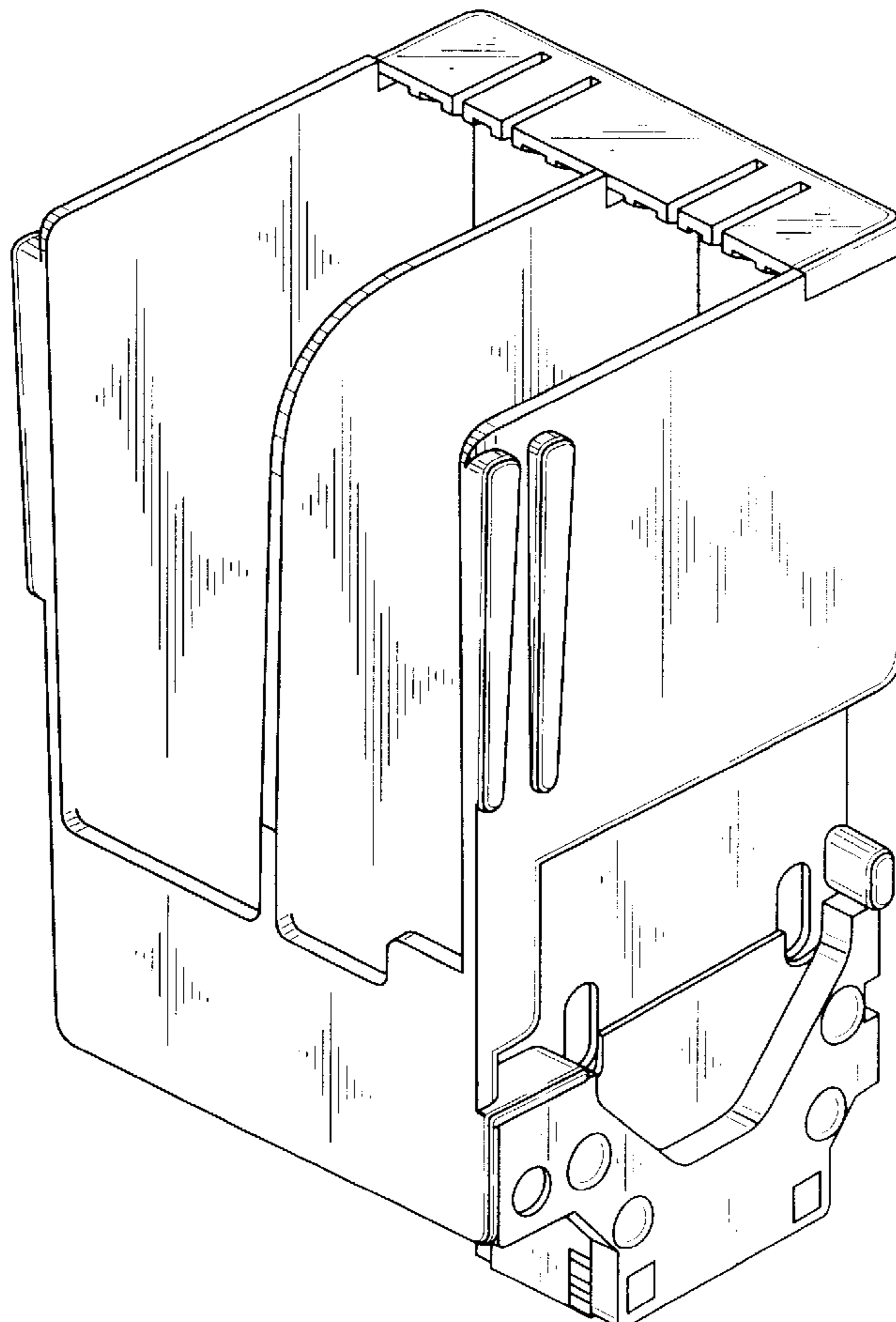

FIG. 1

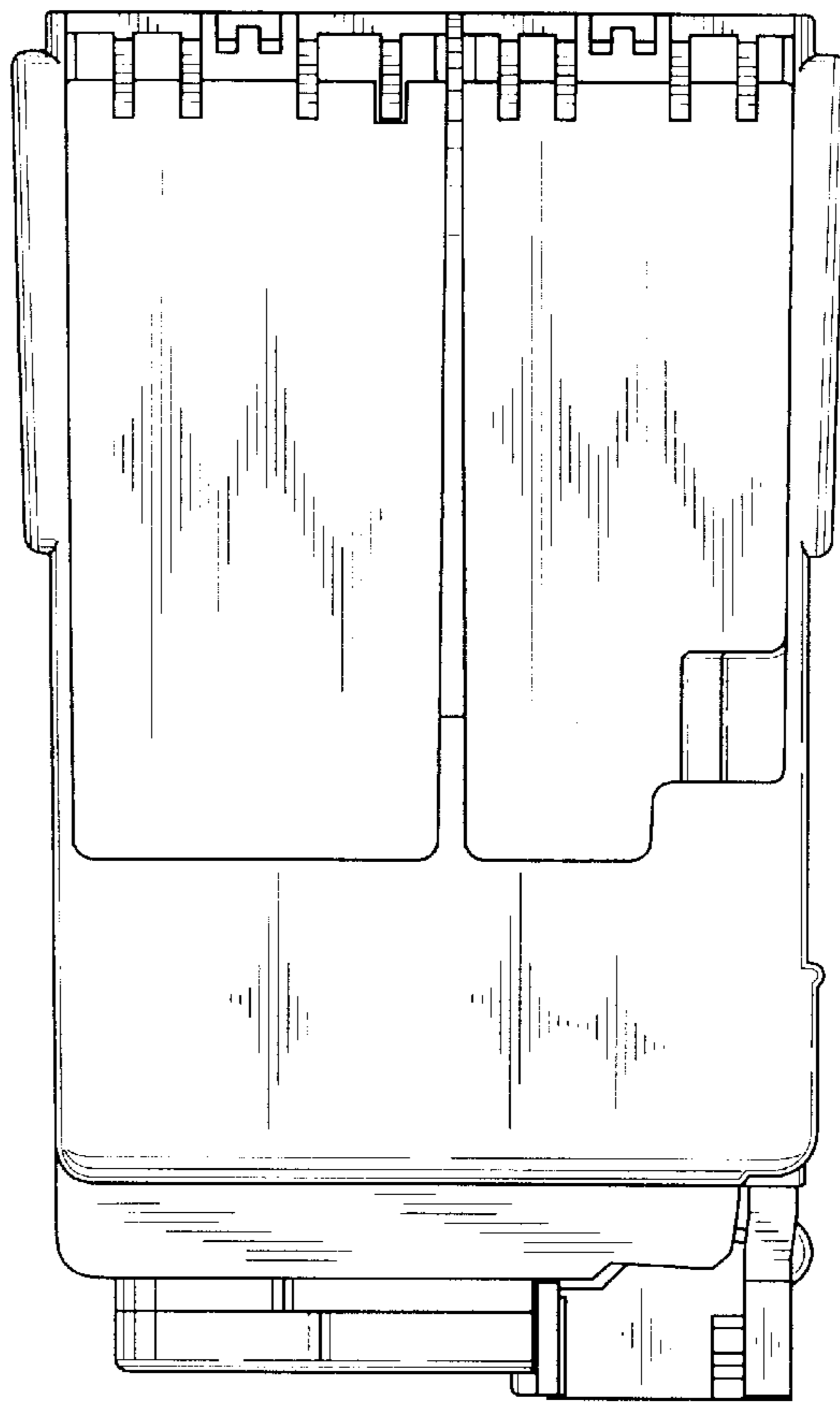

FIG. 2

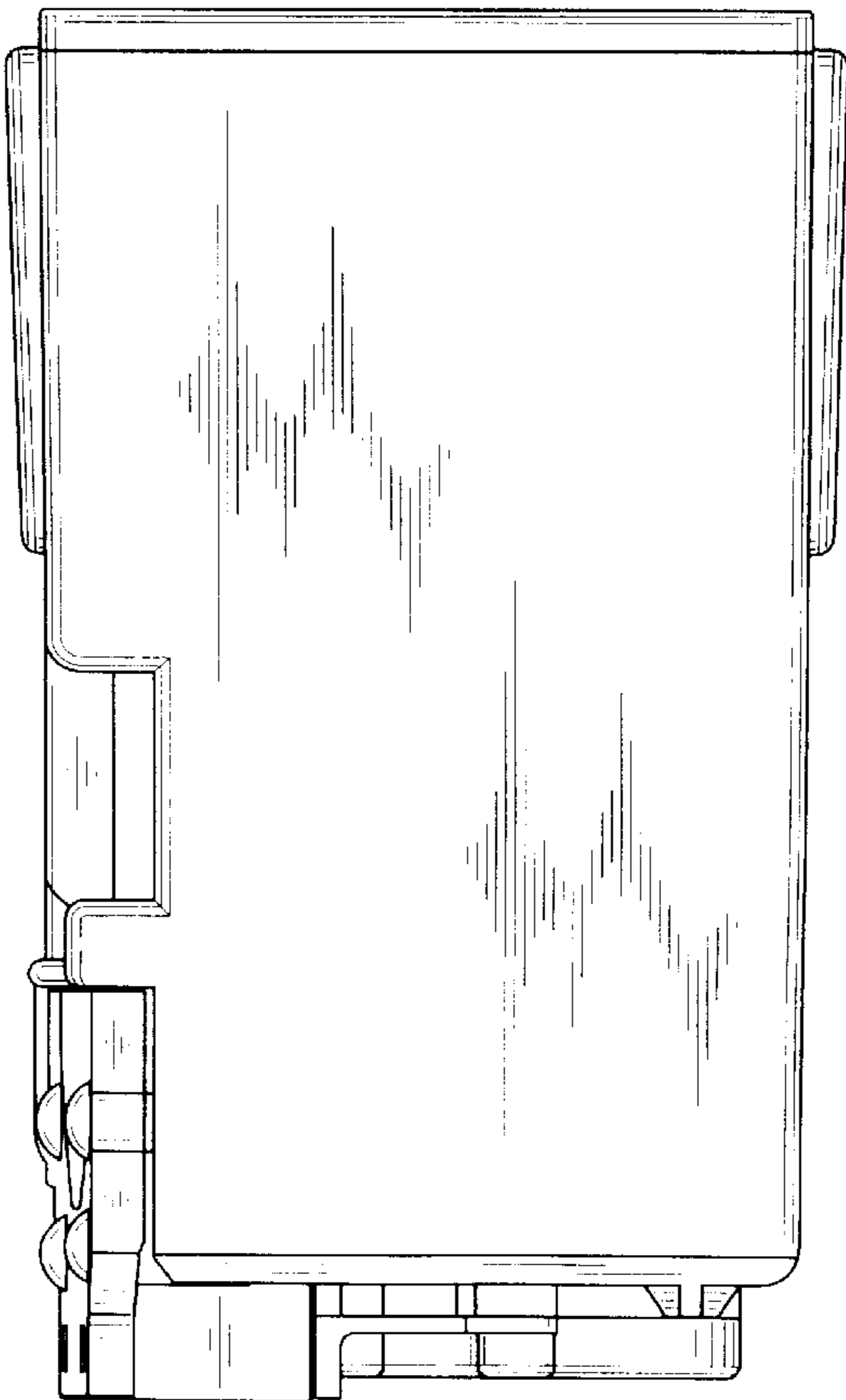

FIG. 3

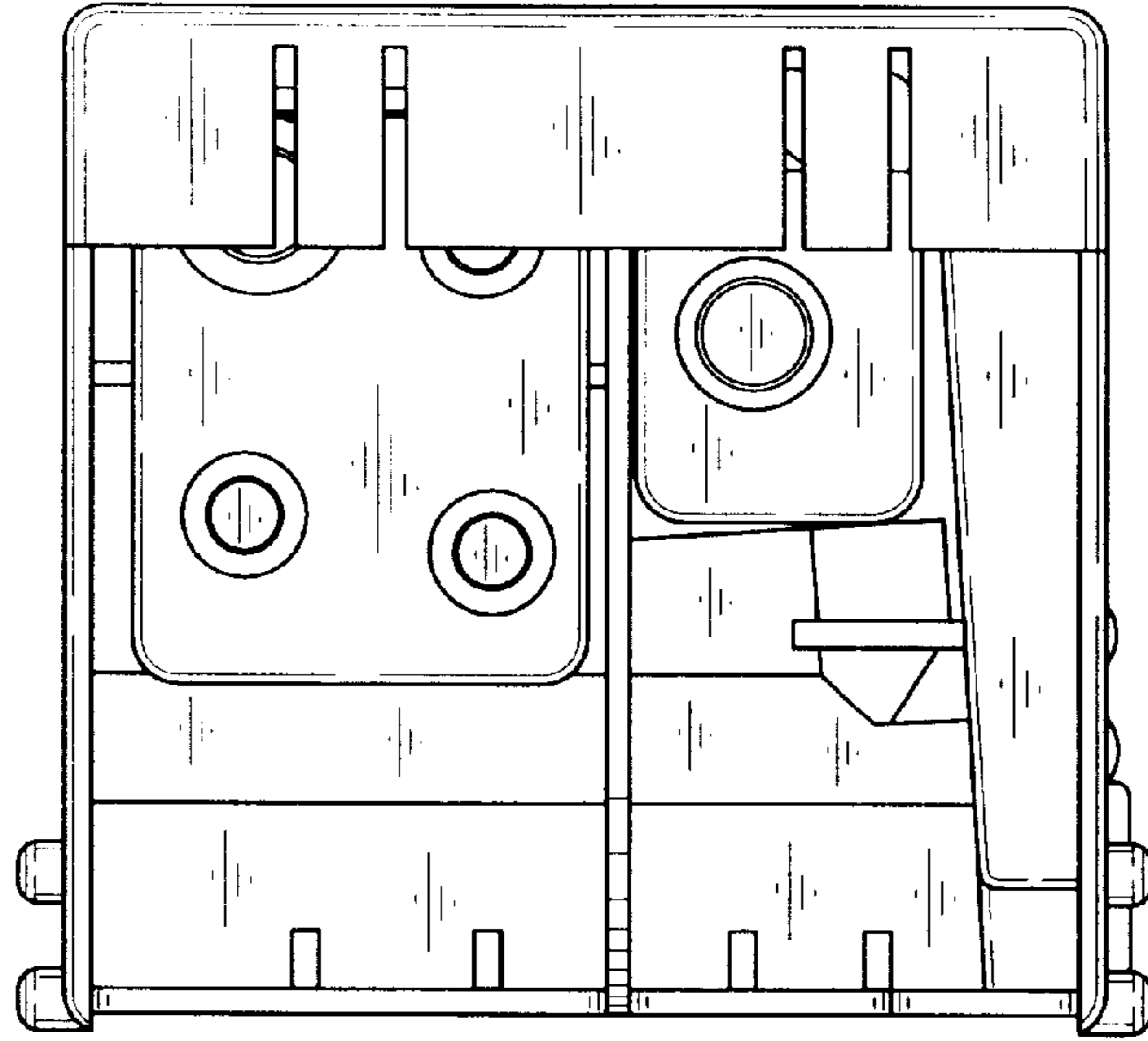

FIG. 4

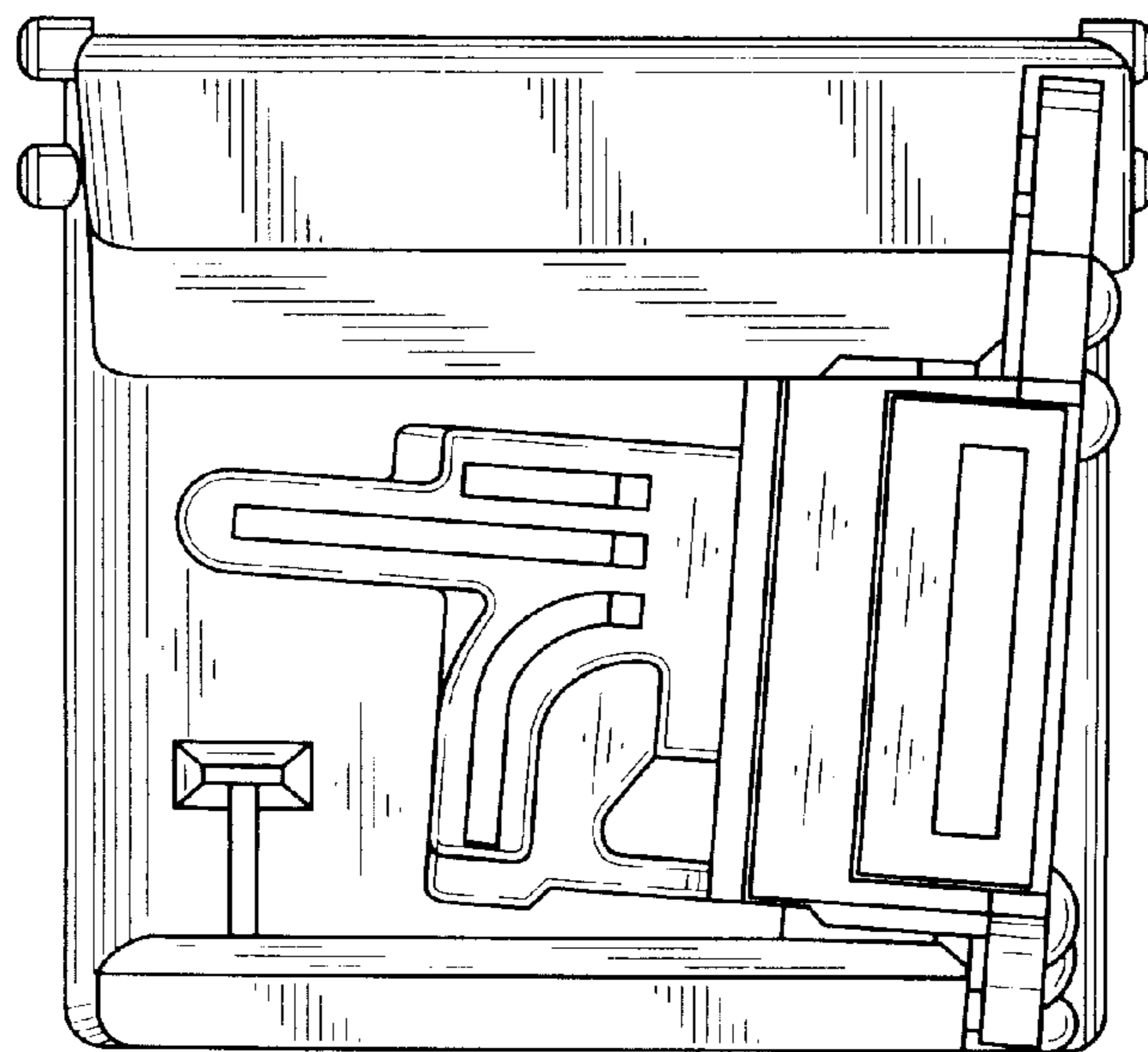

FIG. 5

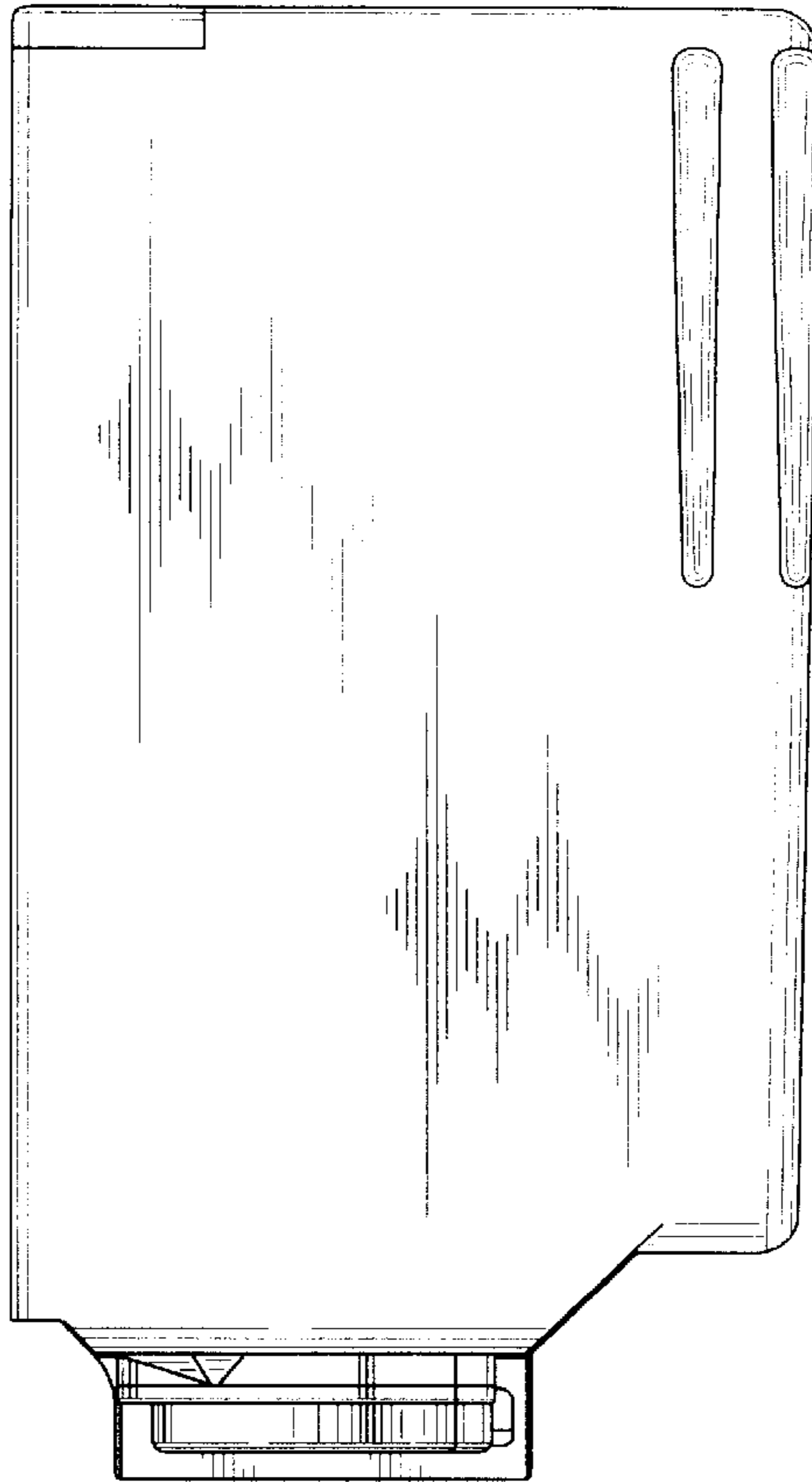

FIG. 6

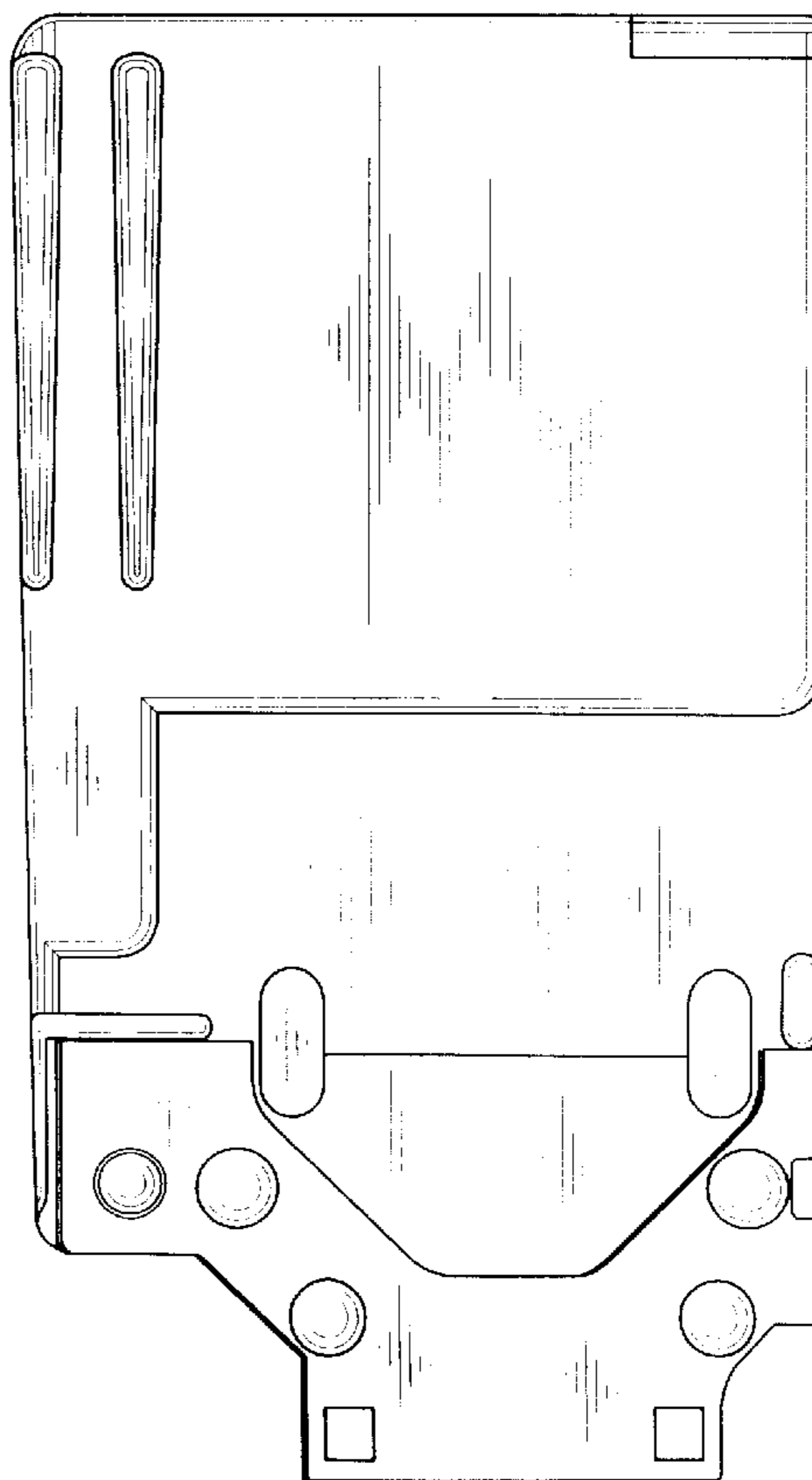

FIG. 7

