



US00D465791S

(12) **United States Design Patent**
Moan

(10) **Patent No.:** **US D465,791 S**

(45) **Date of Patent:** **** Nov. 19, 2002**

- (54) **PUMP**
- (75) Inventor: **Brian Edward Moan**, Luton (GB)
- (73) Assignee: **Huntleigh Technology PLC** (GB)
- (**) Term: **14 Years**
- (21) Appl. No.: **29/156,340**
- (22) Filed: **Feb. 26, 2002**
- (30) **Foreign Application Priority Data**
 Aug. 31, 2001 (GB) 2104476
- (51) **LOC (7) Cl.** **15-02**
- (52) **U.S. Cl.** **D15/7**
- (58) **Field of Search** D15/7-9; 417/410-411,
 417/415, 417, 234-235; D26/38; D24/8;
 340/321, 473, 442; D32/15

- 5,568,117 A * 10/1996 Hsu 340/321
- D403,331 S * 12/1998 Williams D15/9
- D443,736 S * 6/2001 Warth D32/15
- D453,168 S * 1/2002 Chou D15/7

* cited by examiner

Primary Examiner—Ralf Seifert

(74) *Attorney, Agent, or Firm*—Brown Raysman Millstein
Felder & Steiner LLP

- (56) **References Cited**
U.S. PATENT DOCUMENTS
 D122,458 S * 9/1940 Eastman D15/9
 D257,354 S * 10/1980 Fish D15/9
 D277,675 S * 2/1985 Hung D15/9
 D356,800 S * 3/1995 Chen D15/9

(57) **CLAIM**

I claim the ornamental design for a pump, as shown and described.

DESCRIPTION

FIG. 1 is a perspective view of an embodiment of a pump according to my new design;
 FIG. 2 is a front view thereof;
 FIG. 3 is a top view thereof;
 FIG. 4 is a bottom view thereof;
 FIG. 5 is a back view thereof;
 FIG. 6 is a right side view thereof;
 FIG. 7 is a left side view thereof; and,
 FIG. 8 is a perspective view of an alternative embodiment of the pump according to my new design.

1 Claim, 4 Drawing Sheets

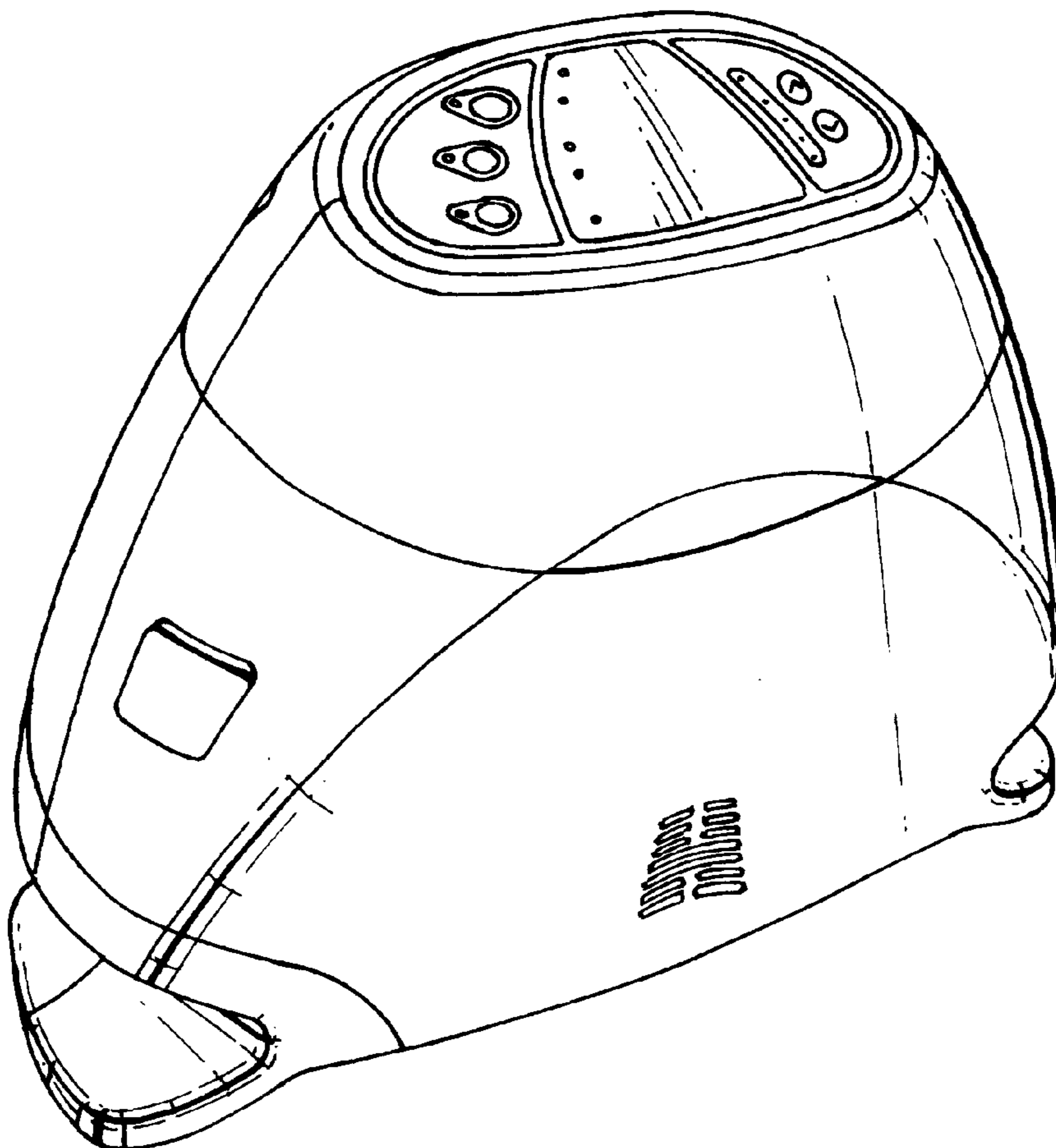

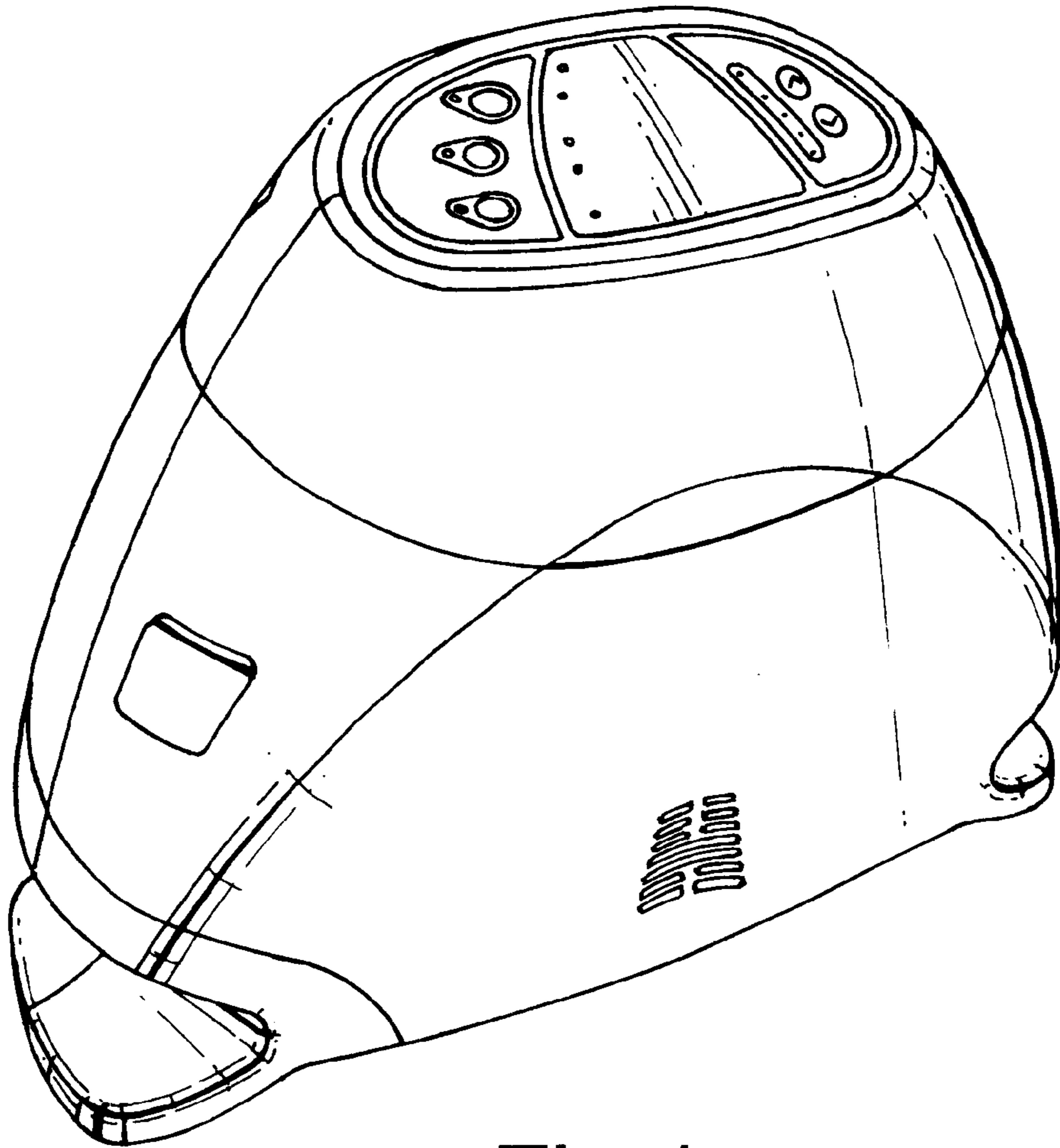

Fig. 1.

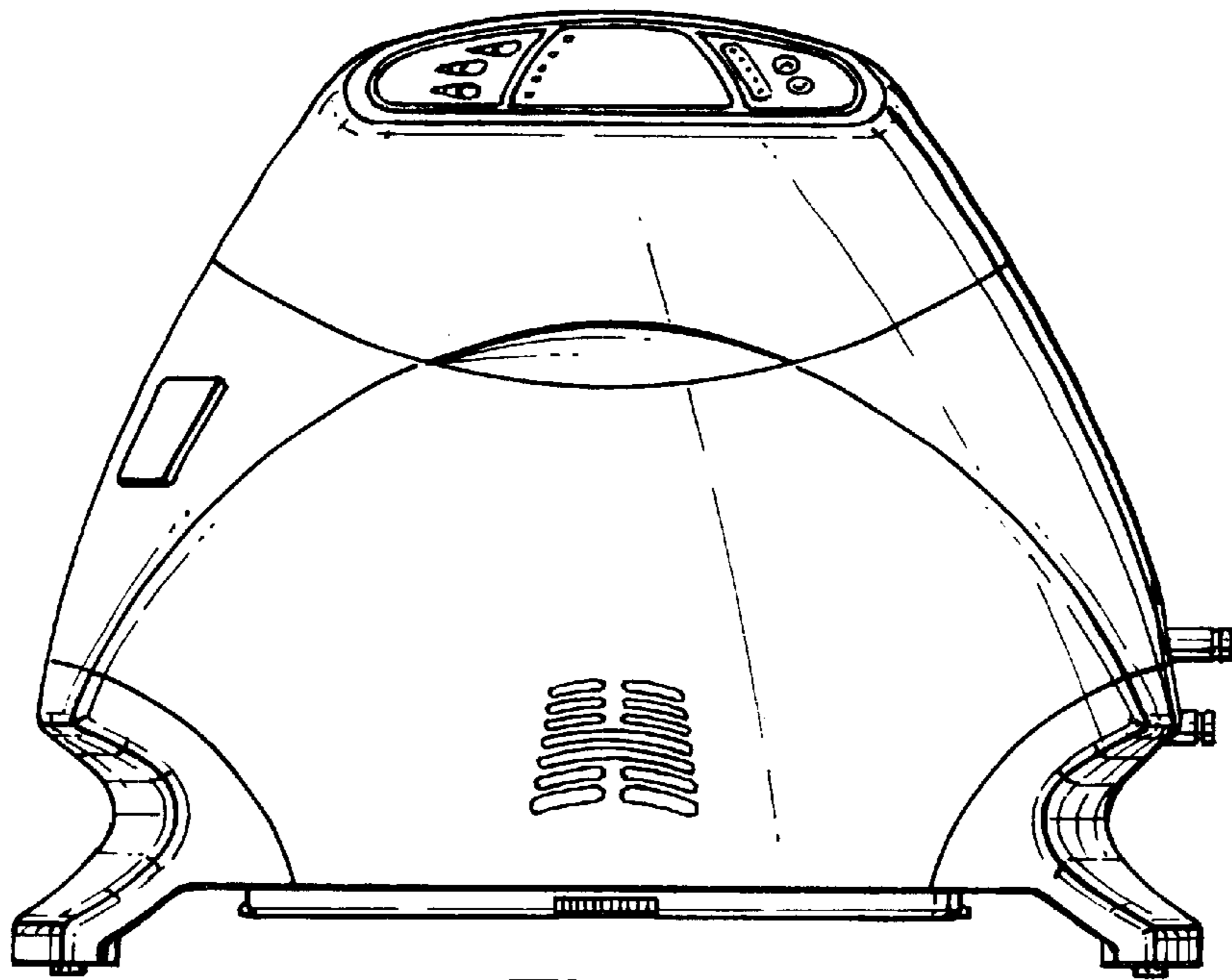

Fig.2.

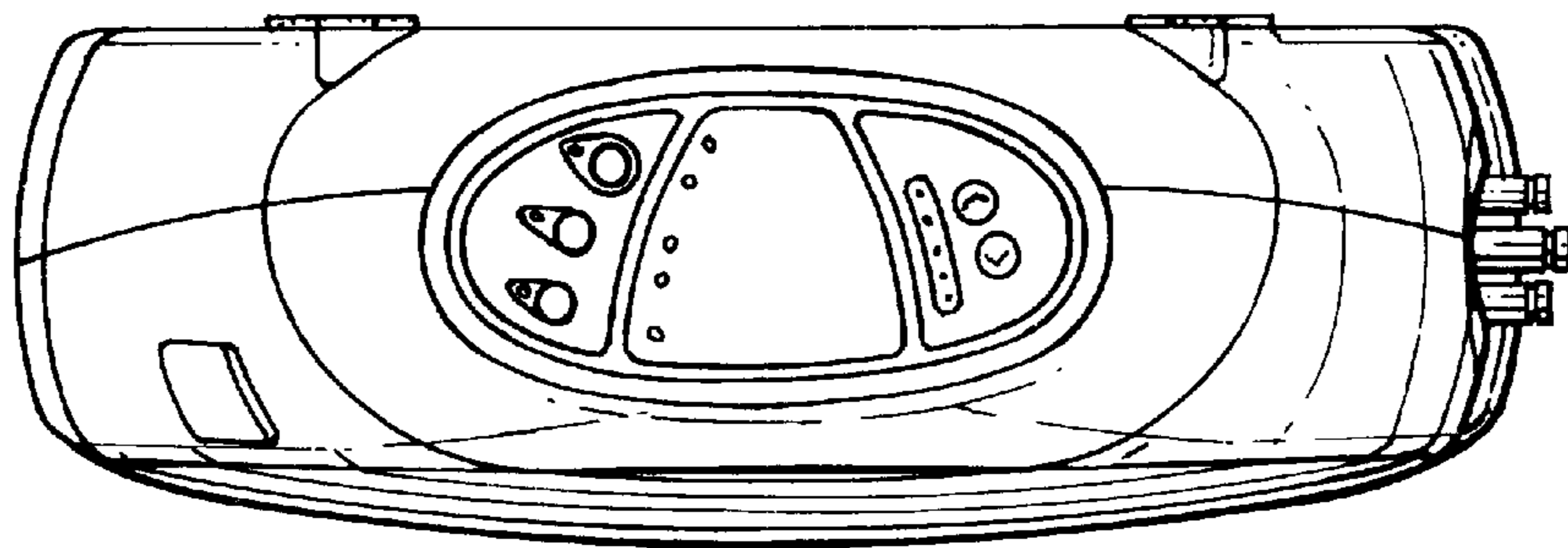

Fig.3.

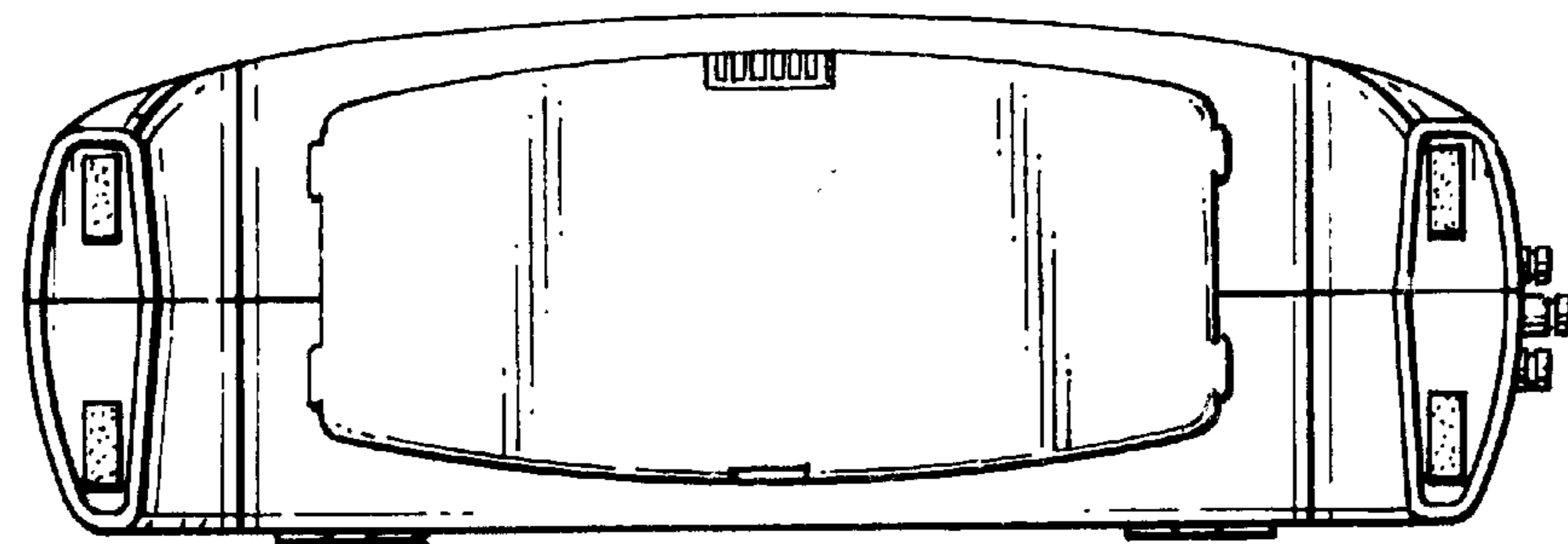

Fig.4.

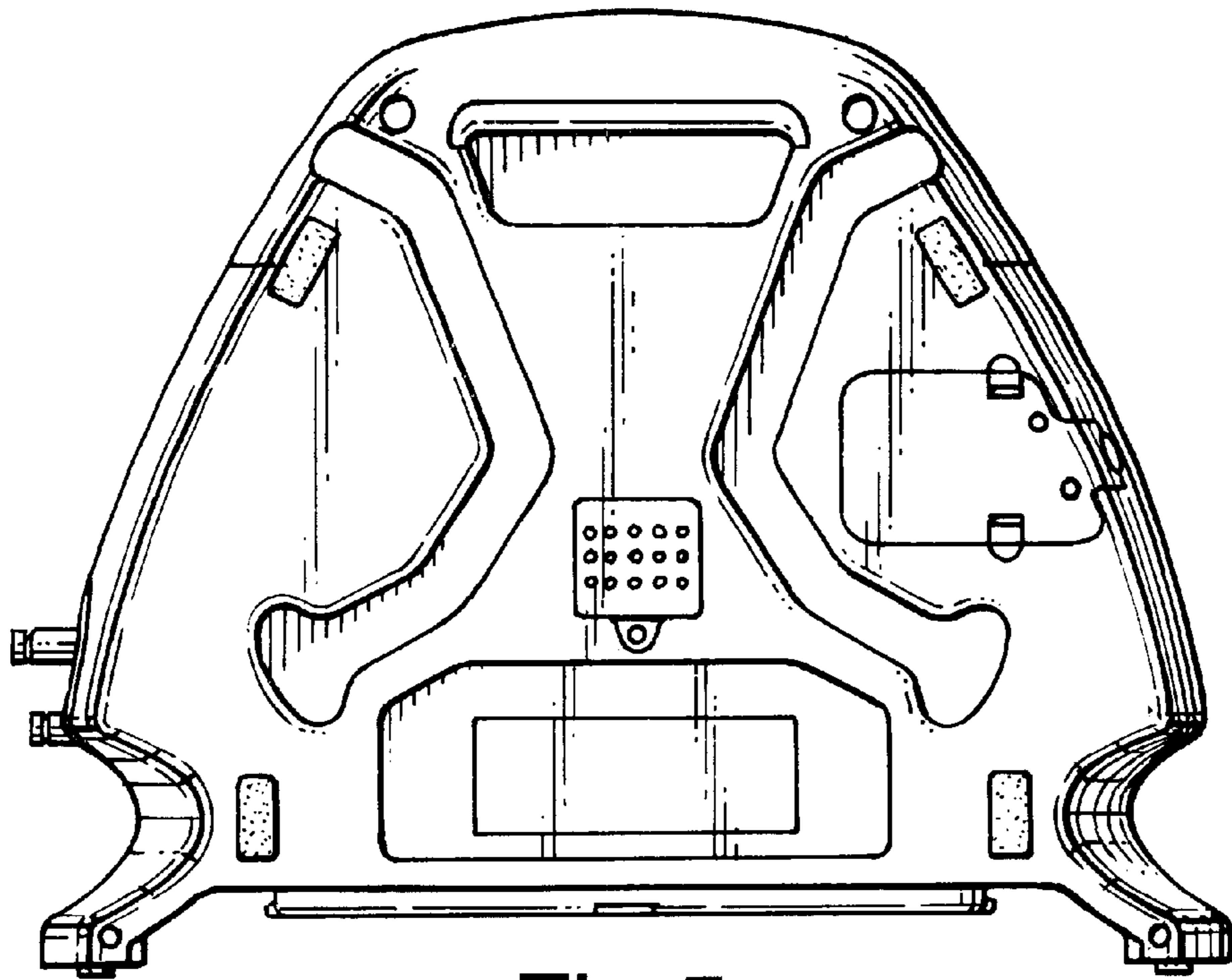

Fig.5.

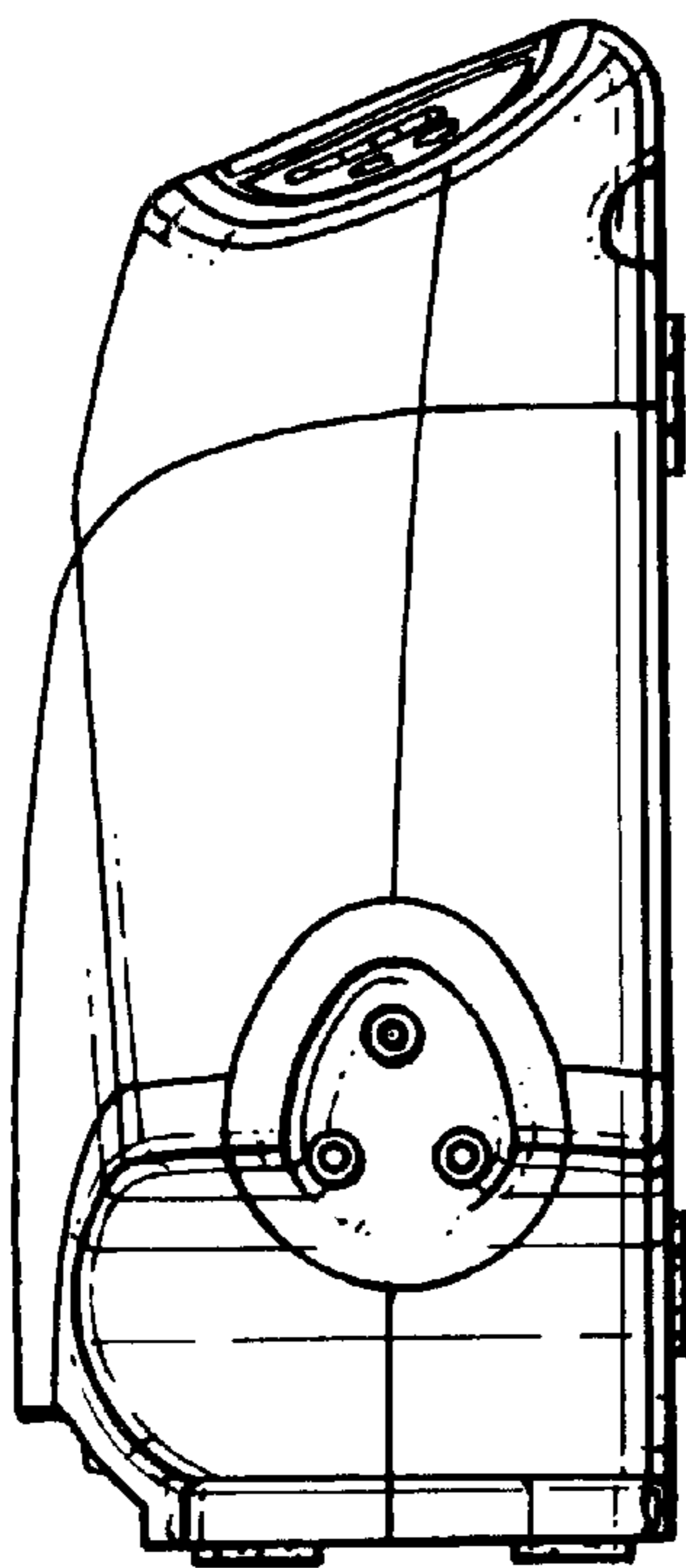

Fig.6.

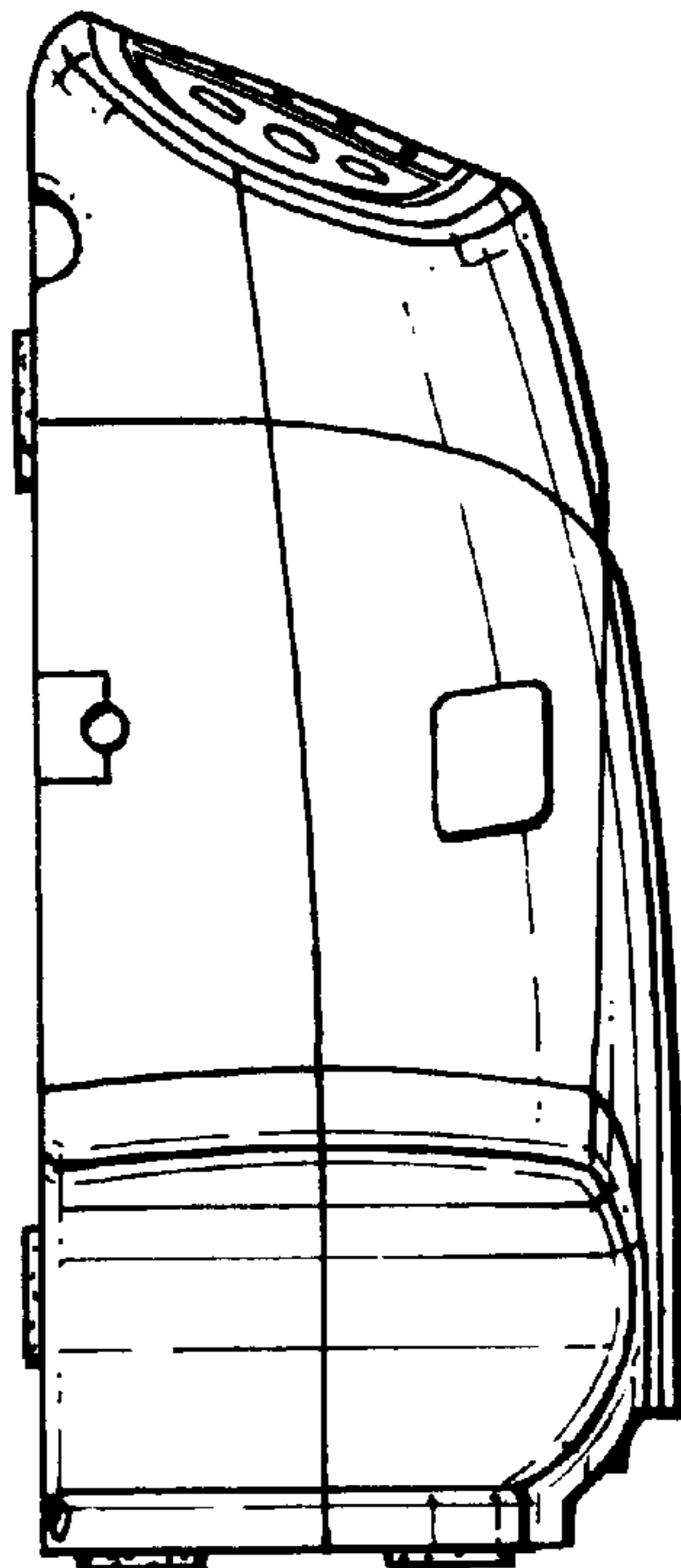

Fig.7.

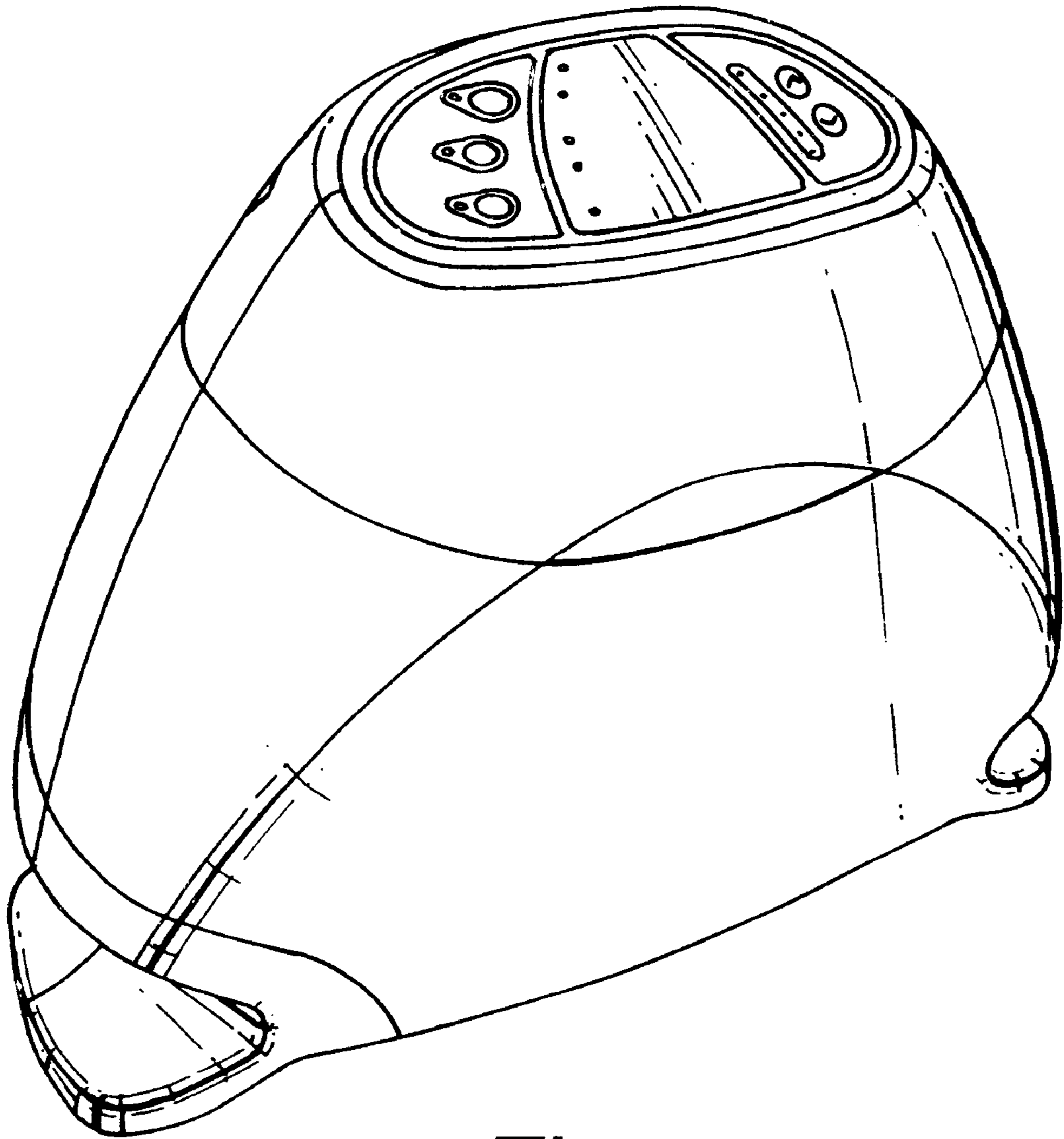

Fig. 8.