



US00D465756S

(12) **United States Design Patent**
Hernandez

(10) **Patent No.:** **US D465,756 S**

(45) **Date of Patent:** **** Nov. 19, 2002**

(54) **VEHICLE ORNAMENT**

(76) Inventor: **Rinaldo Hernandez**, 1350 Boston Ave.,
Bayshore, NY (US) 11706

(**) Term: **14 Years**

(21) Appl. No.: **29/156,280**

(22) Filed: **Feb. 25, 2002**

(51) **LOC (7) Cl.** **12-16**

(52) **U.S. Cl.** **D12/197**

(58) **Field of Search** D12/197-201,
D12/400, 214; 40/411-413, 424-425; 446/36;
D2/895

(56) **References Cited**

U.S. PATENT DOCUMENTS

D40,664 S	*	4/1910	Phipps	D12/197
D53,759 S	*	8/1919	Wolter	D12/197
D60,492 S	*	2/1922	Harris	D12/197
D73,985 S	*	11/1927	Swendsen	D12/197
D74,813 S	*	3/1928	Van Gunten	D12/197
D75,669 S	*	6/1928	Witt	D12/197
D77,894 S	*	3/1929	Dietsch	D12/197
D79,333 S	*	9/1929	Intingaro	D12/197
D79,728 S	*	10/1929	Kurilla	D12/197
D80,334 S	*	1/1930	Smith	D12/197
D152,705 S	*	2/1949	Leahy	D12/214

D161,529 S	*	1/1951	Pope, Sr.	D12/197
D180,435 S	*	6/1957	Auren	D12/197
D295,738 S	*	5/1988	Federico	D12/197
D422,958 S	*	4/2000	Conway et al.	D12/197

* cited by examiner

Primary Examiner—Stacia Cadmus

(74) *Attorney, Agent, or Firm*—Thomas A. O'Rourke;
Wyatt Gerber & O'Rourke

(57) **CLAIM**

The ornamental design for a vehicle ornament, as shown and described.

DESCRIPTION

FIG. 1 is a top view of the vehicle ornament of the present invention;

FIG. 2 is a bottom view of the vehicle ornament of FIG. 1; FIG. 3 is a side view of the vehicle ornament illustrated in FIG. 1.

FIG. 4 is a side view of the vehicle ornament of the present invention from the side opposite FIG. 3.

FIG. 5 is an end view of the vehicle ornament of the present invention; and,

FIG. 6 is an end view of the vehicle ornament from the end opposite FIG. 5.

1 Claim, 2 Drawing Sheets

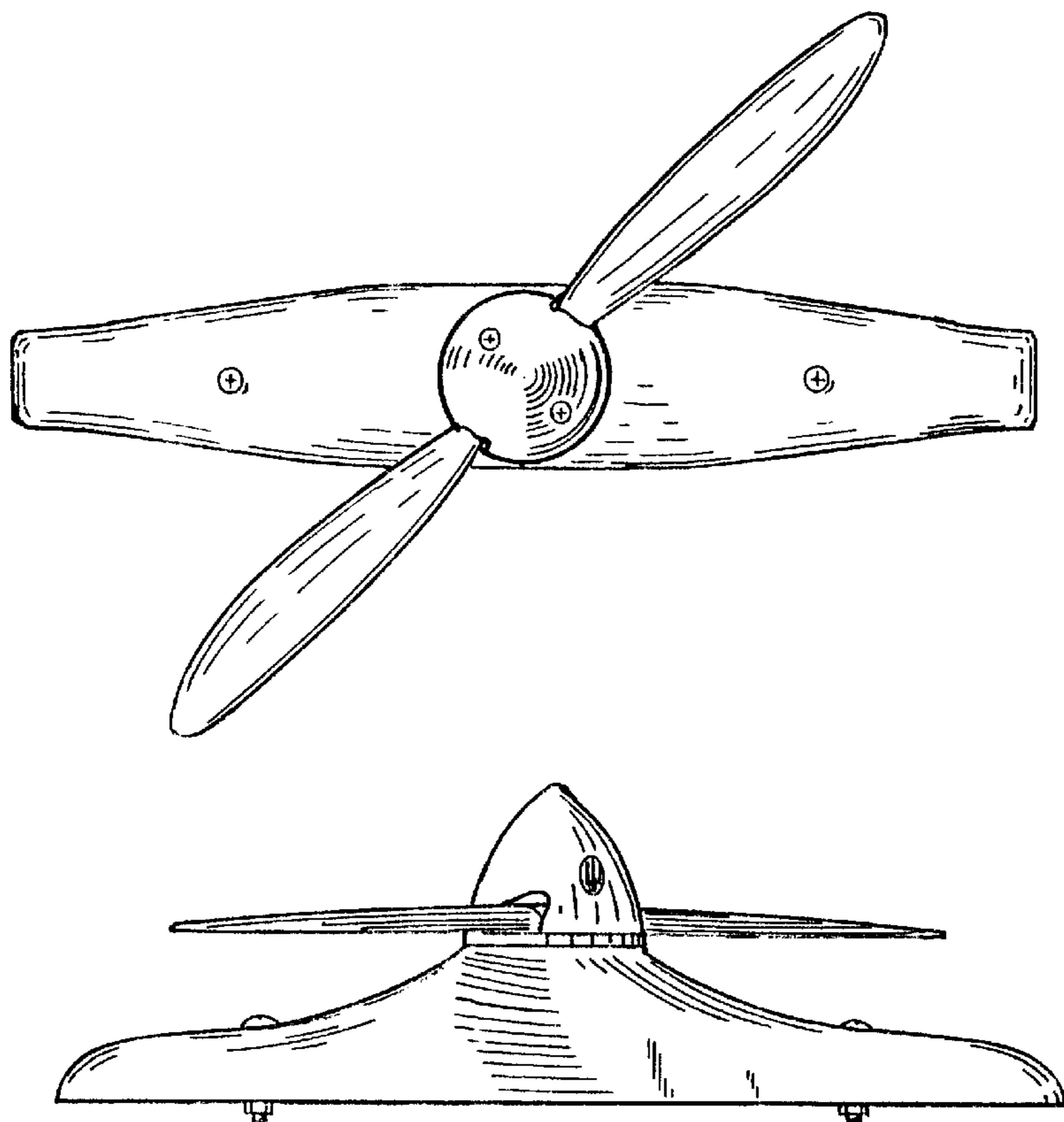

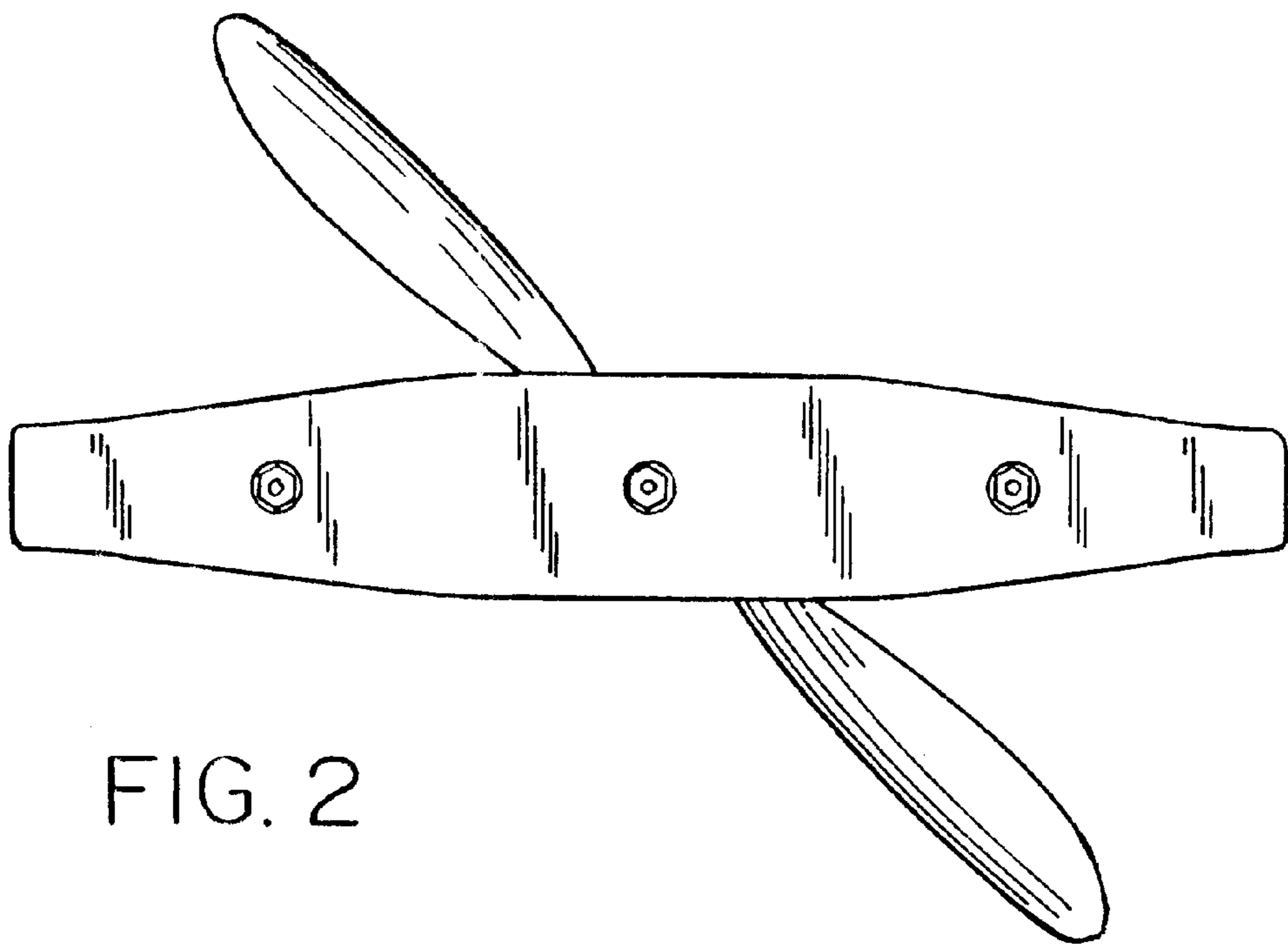
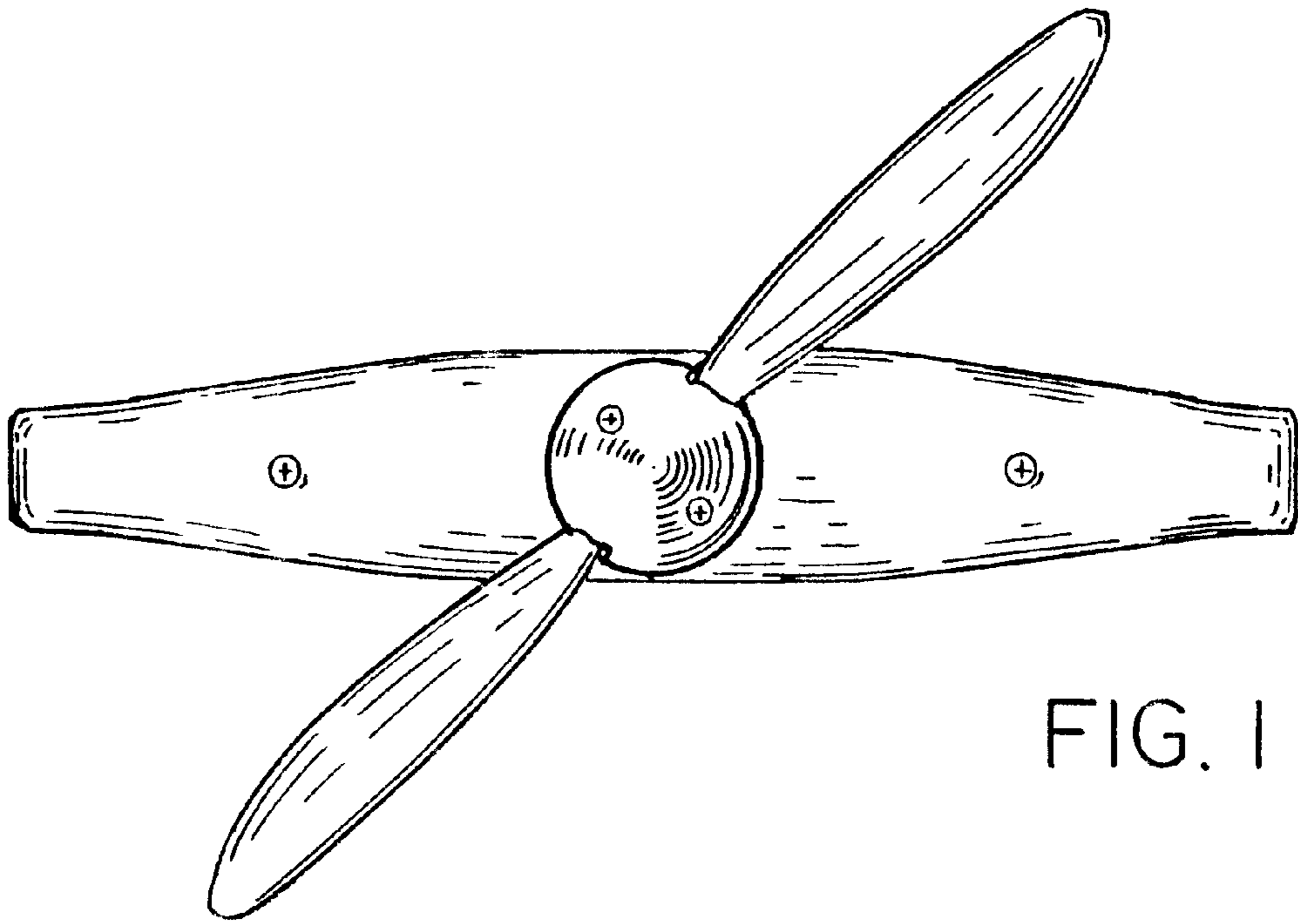

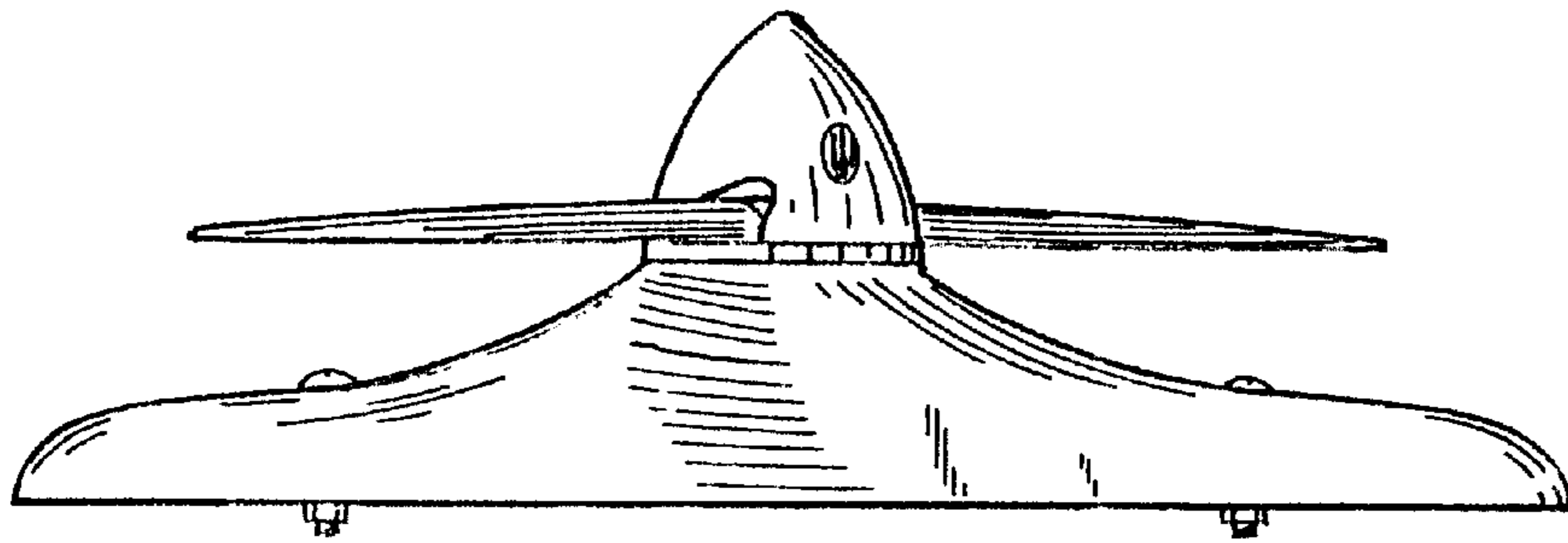

FIG. 3

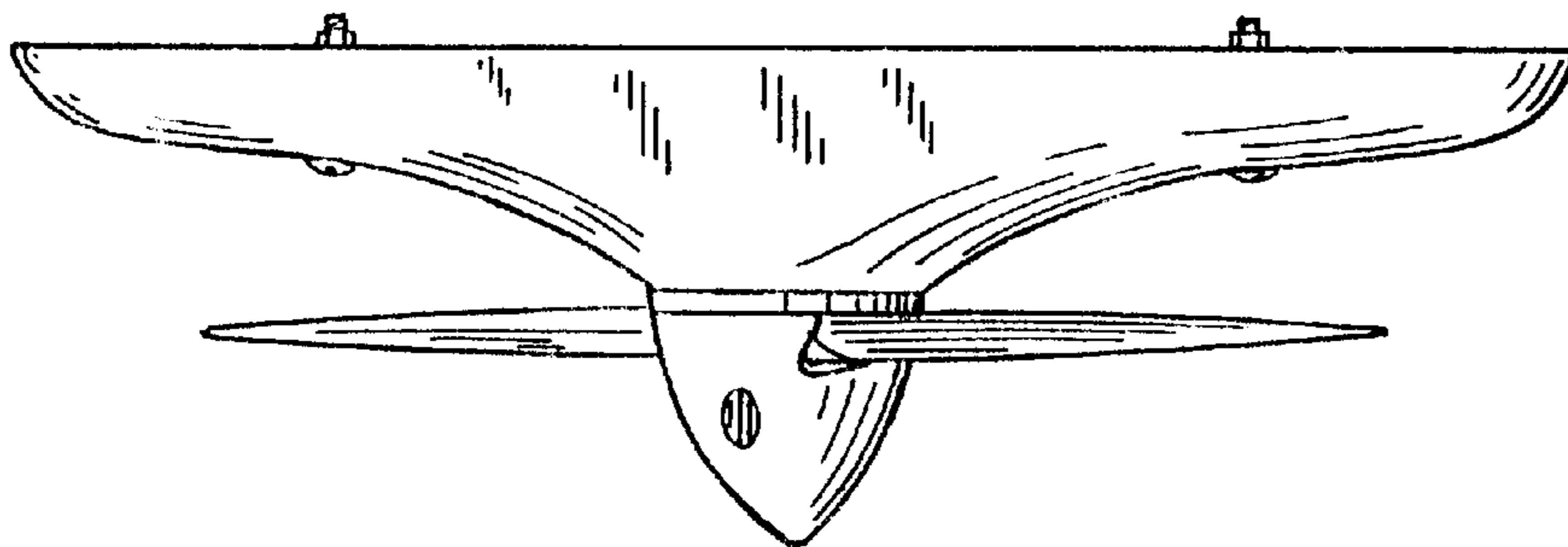

FIG. 4

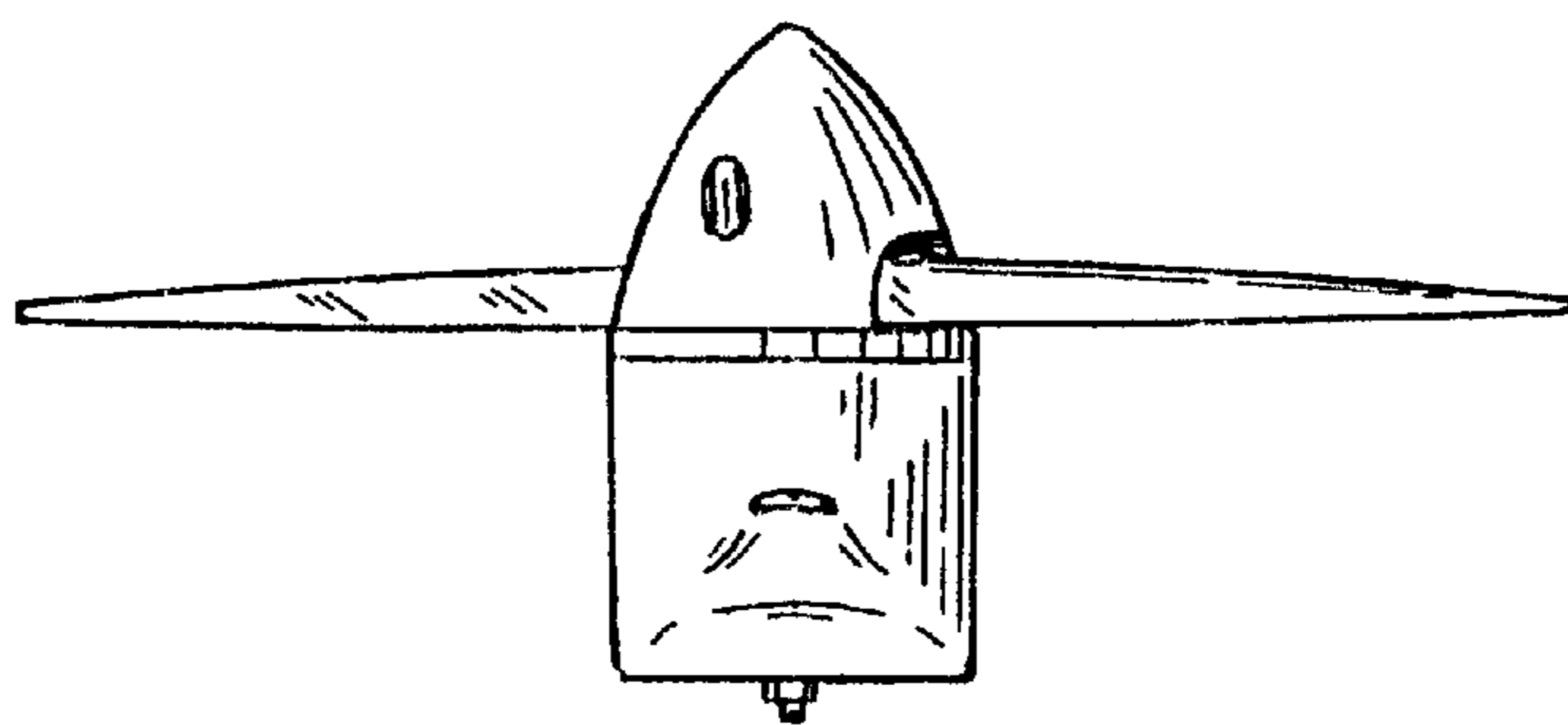

FIG. 5

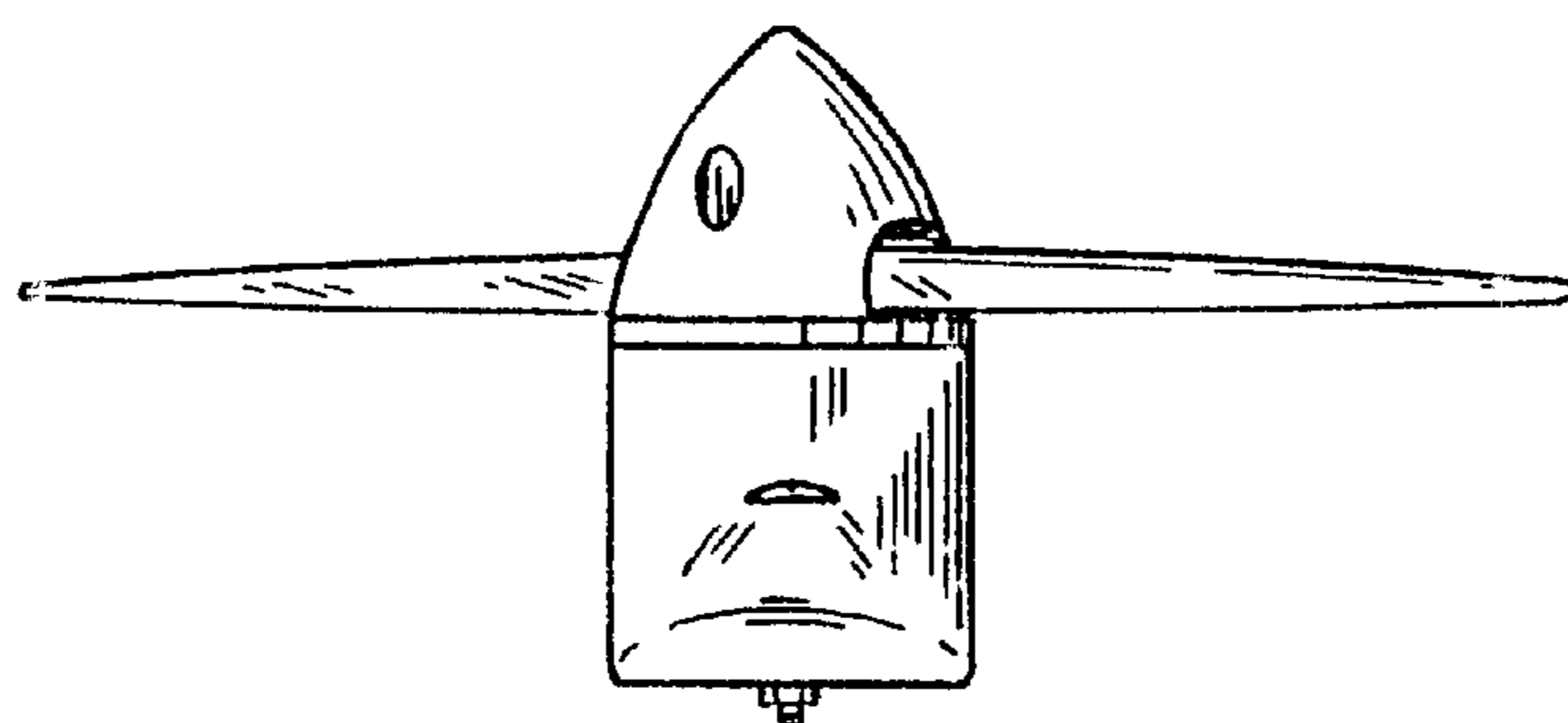

FIG. 6