



US00D465549S

(12) **United States Design Patent**  
**Tse**

(10) **Patent No.:** **US D465,549 S**

(45) **Date of Patent:** **\*\* Nov. 12, 2002**

(54) **SHOWERHEAD**

D440,630 S \* 4/2001 Gottwald ..... D23/223

(75) Inventor: **Hing Fai Tse, Tai Po (HK)**

\* cited by examiner

(73) Assignee: **Brand New Technology Ltd., Kowloon (HK)**

*Primary Examiner*—Robin V. Taylor

(74) *Attorney, Agent, or Firm*—Leydig, Voit & Mayer, Ltd.

(\*\*) Term: **14 Years**

(57) **CLAIM**

(21) Appl. No.: **29/153,226**

The ornamental design for a showerhead, as shown and described.

(22) Filed: **Jan. 8, 2002**

**DESCRIPTION**

(51) **LOC (7) Cl.** ..... **23-01**

(52) **U.S. Cl.** ..... **D23/223**

(58) **Field of Search** ..... D23/213, 223,  
D23/226, 229, 230; 239/394, 462

FIG. 1 is a front and right side perspective view of a showerhead showing my new design;

FIG. 2 is a front elevational view thereof;

FIG. 3 is a rear elevational view thereof;

FIG. 4 is a right side elevational view thereof;

FIG. 5 is a left side elevational view thereof;

FIG. 6 is a top end elevational view thereof; and,

FIG. 7 is a bottom end elevational view thereof.

(56) **References Cited**

**U.S. PATENT DOCUMENTS**

D432,625 S \* 10/2000 Chan ..... D23/223

D434,468 S \* 11/2000 Chan ..... D23/223

D439,306 S \* 3/2001 Tse ..... D23/223

**1 Claim, 4 Drawing Sheets**

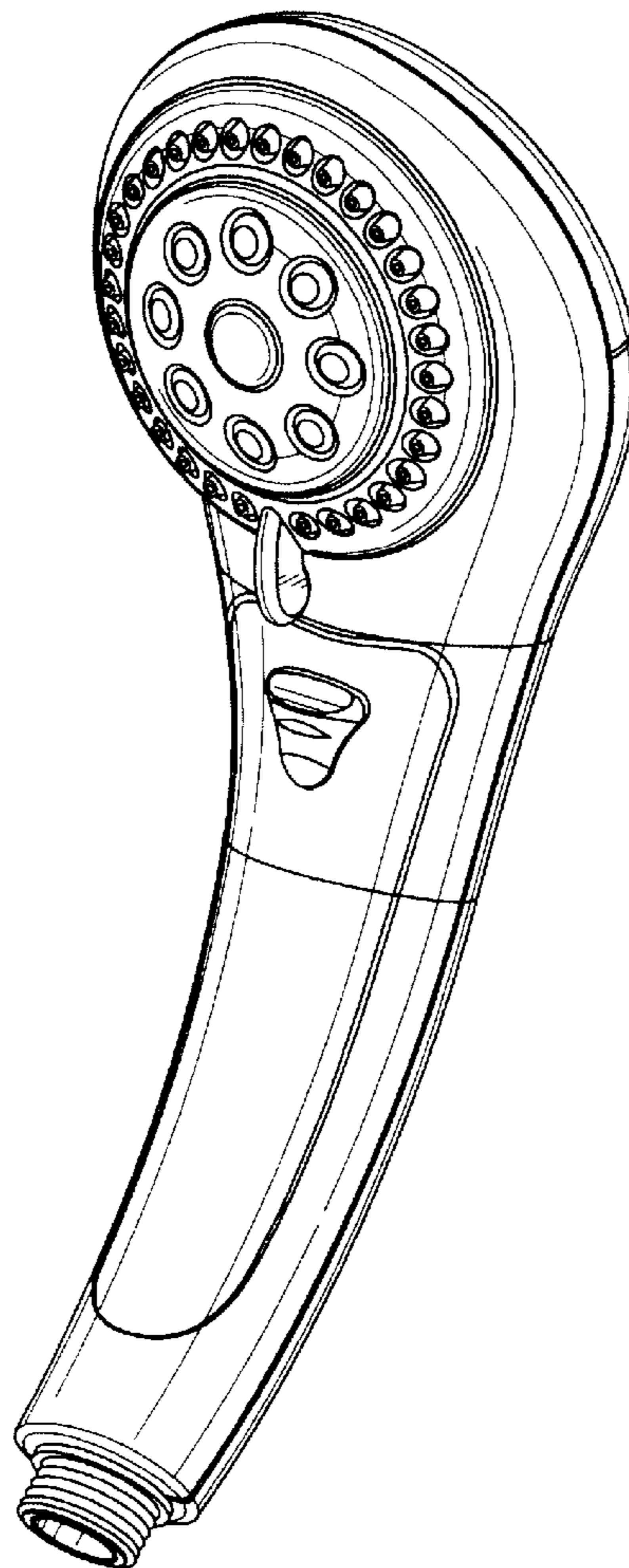

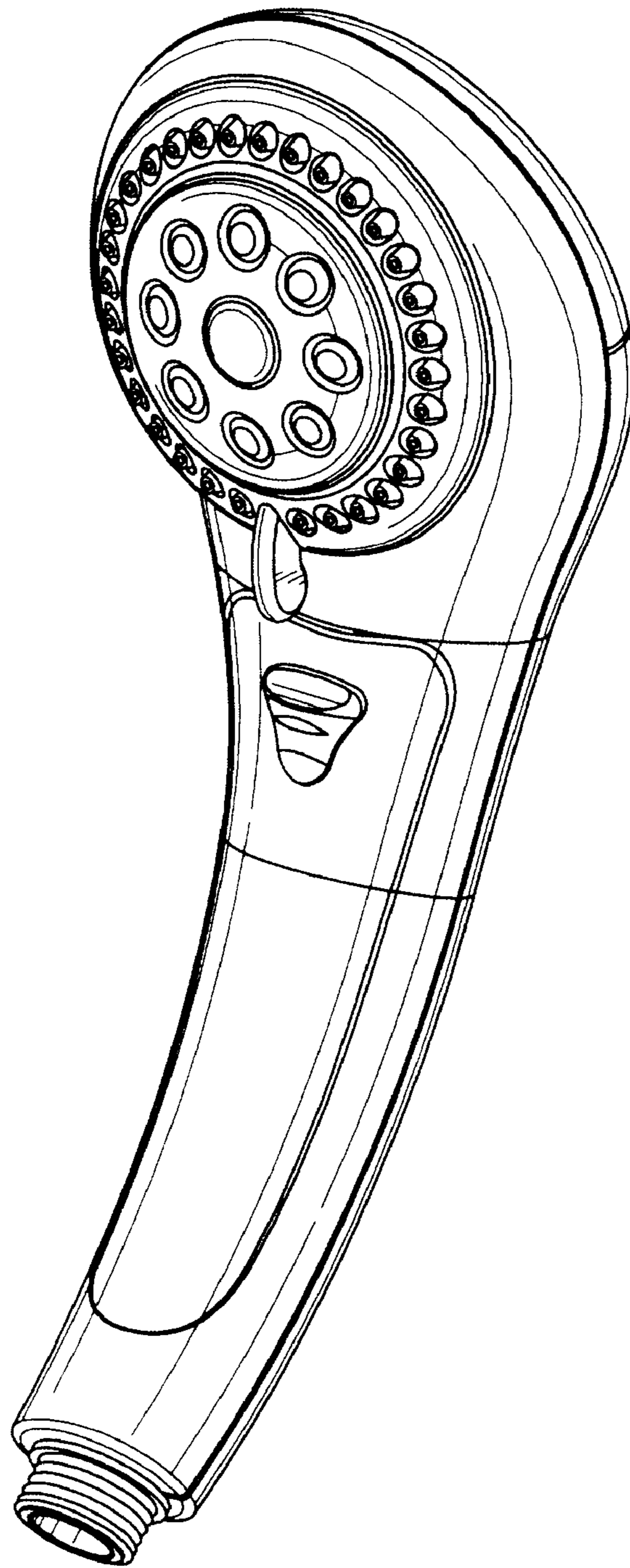

FIG. 1

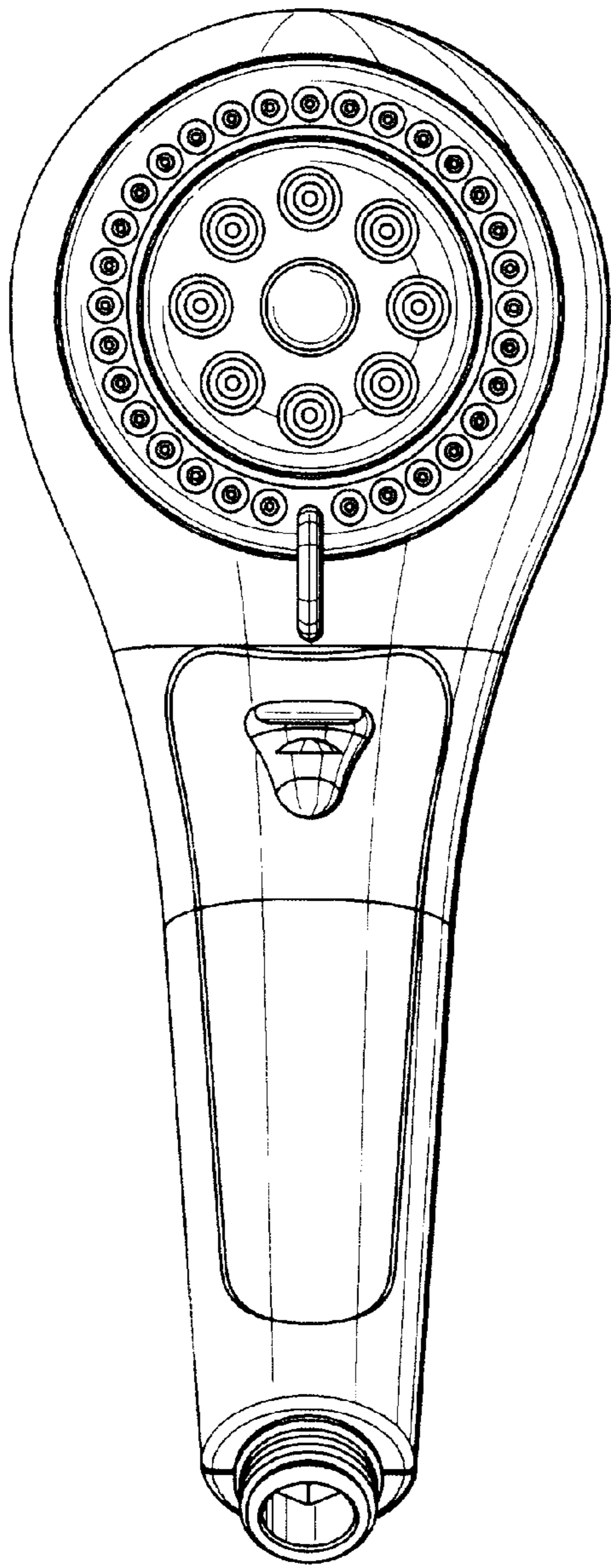

FIG. 2

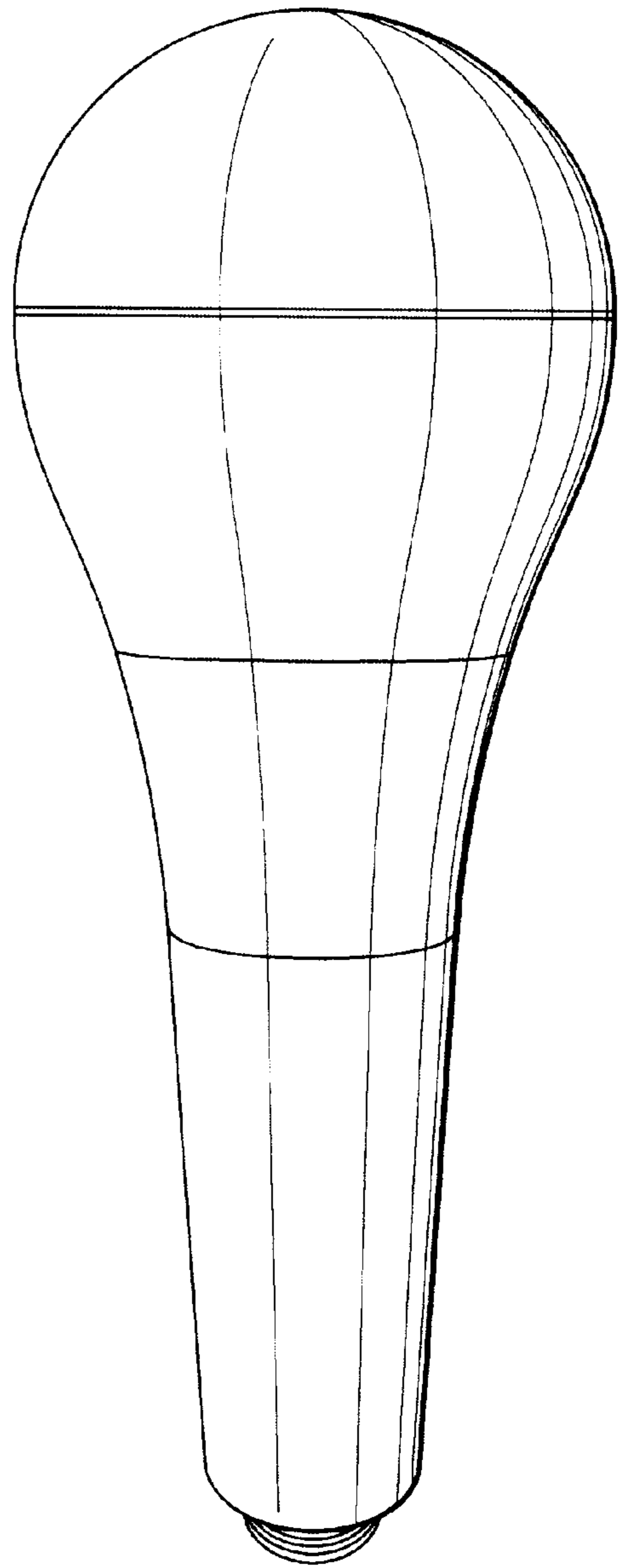

FIG. 3

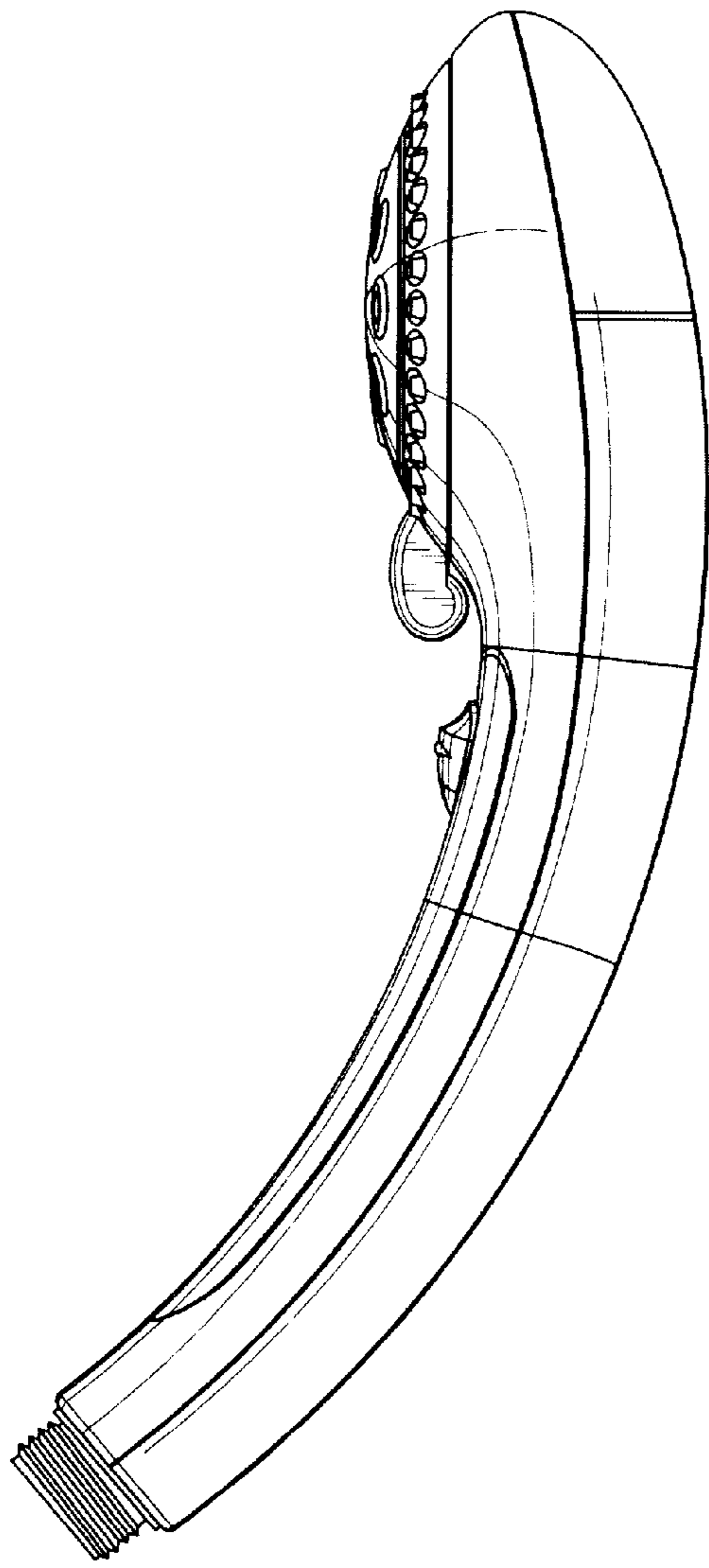

FIG. 4

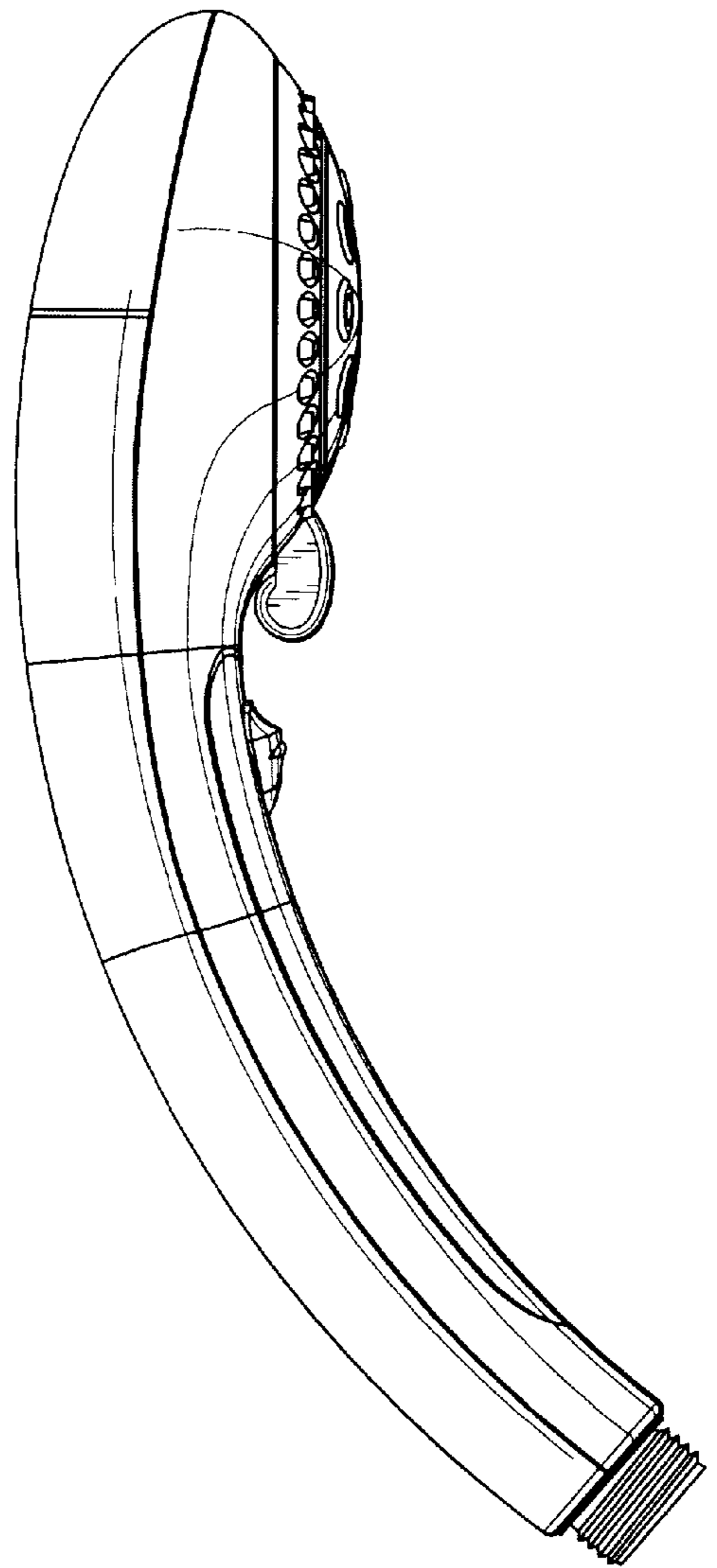

FIG. 5

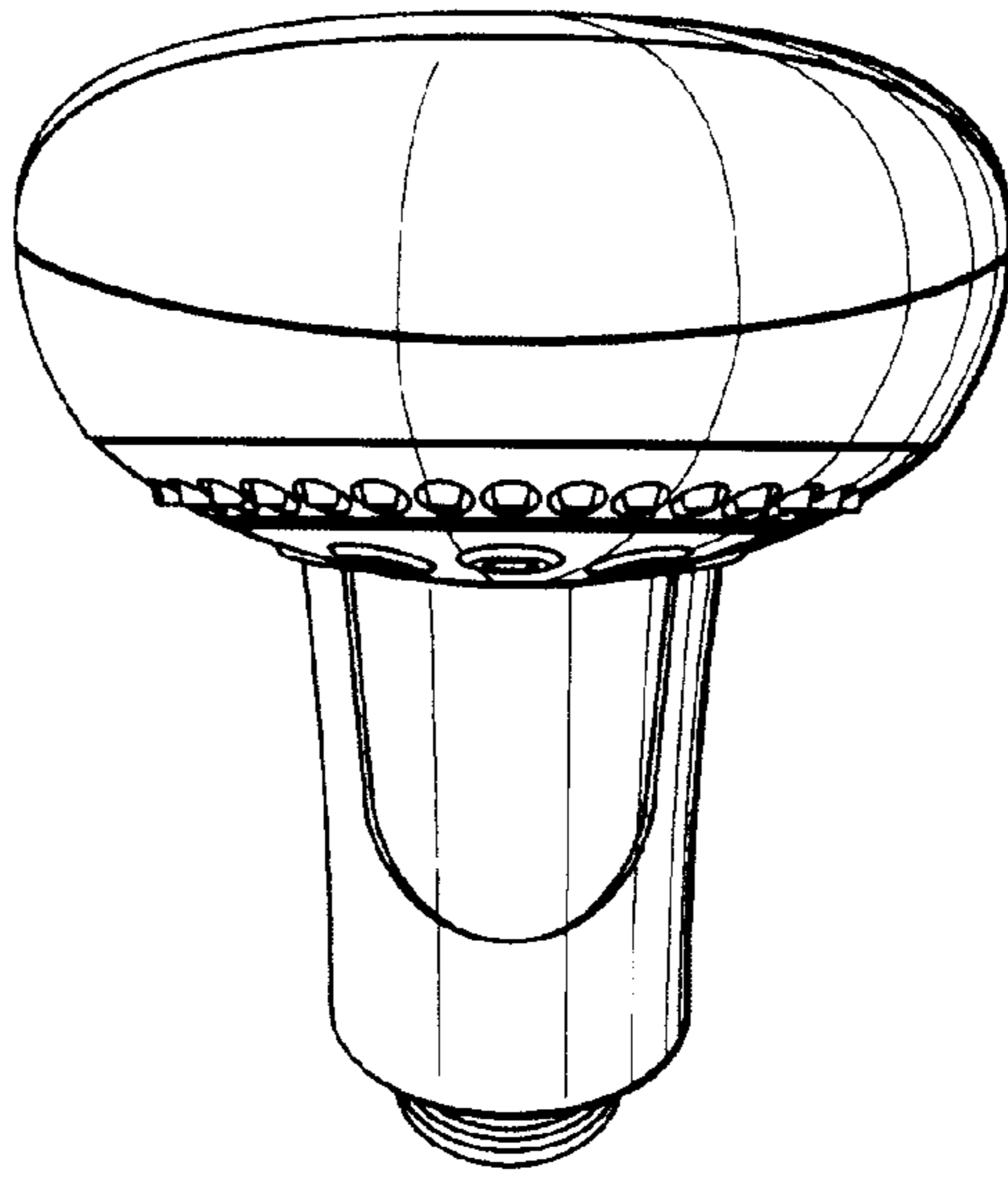

FIG. 6

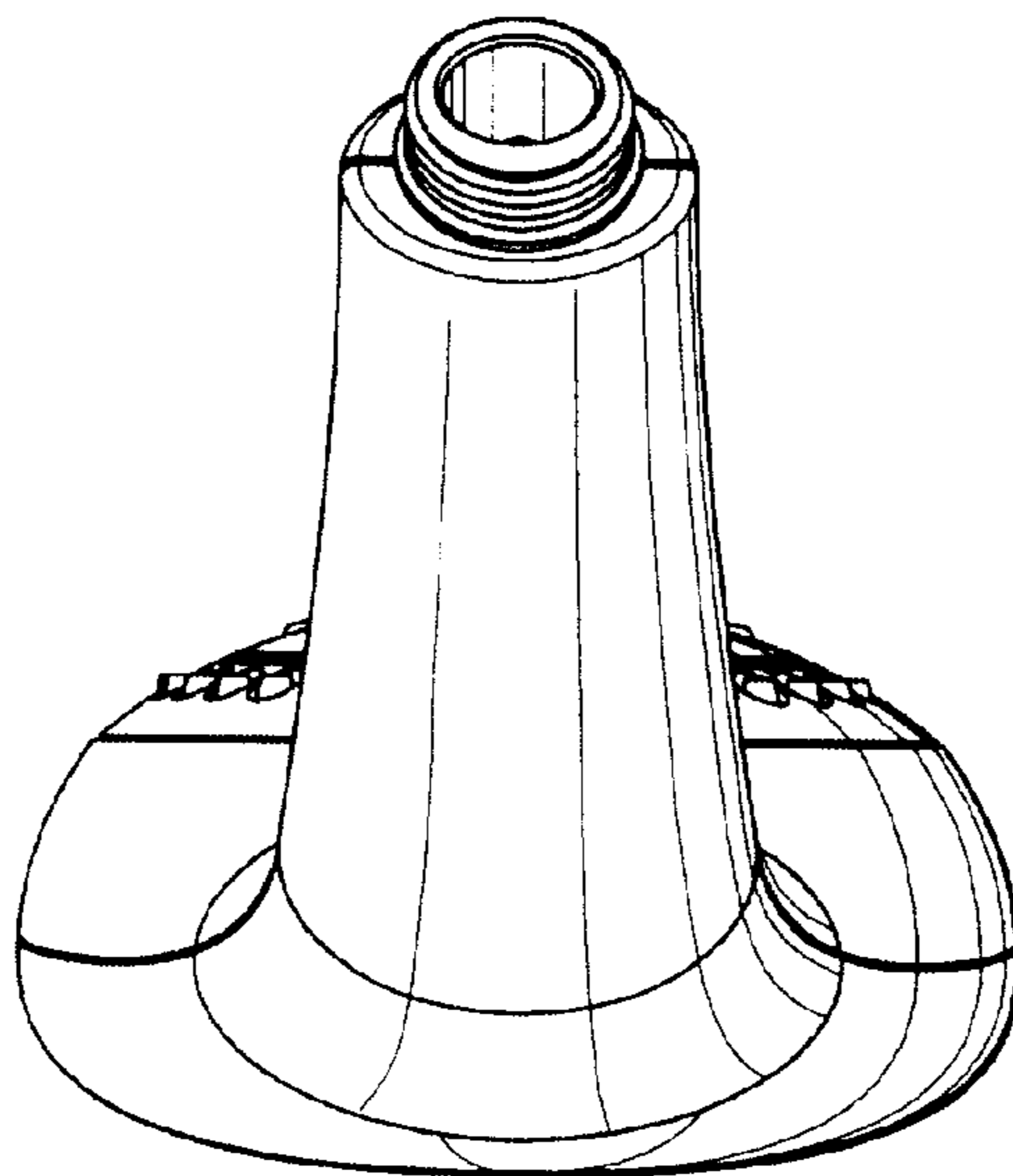

FIG. 7