



US00D465495S

(12) **United States Design Patent**  
**Goto**

(10) **Patent No.:** **US D465,495 S**

(45) **Date of Patent:** **\*\* Nov. 12, 2002**

(54) **INTERFACE UNIT FOR COMPUTER**

JP	889840	2/1994
JP	890760	2/1994
JP	1009939	5/1998

(75) Inventor: **Teiyu Goto**, Tokyo (JP)

(73) Assignee: **Sony Computer Entertainment Inc.**,  
Tokyo (JP)

(\*\*) Term: **14 Years**

(21) Appl. No.: **29/150,235**

(22) Filed: **Nov. 15, 2001**

(30) **Foreign Application Priority Data**

Sep. 10, 2001 (JP) ..... 2001-026562

(51) **LOC (7) Cl.** ..... **14-02**

(52) **U.S. Cl.** ..... **D14/433; D14/242**

(58) **Field of Search** ..... D14/432-439,  
D14/242, 191; 439/610, 620; 361/681-686

(56) **References Cited**

**U.S. PATENT DOCUMENTS**

D331,395 S	*	12/1992	Lou	.....	D14/433
D340,059 S	*	10/1993	Wetzel et al.	.....	D14/433
D345,980 S		4/1994	Scheid et al.	.....	D14/191
D361,332 S	*	8/1995	Scheid et al.	.....	D14/191
D366,047 S	*	1/1996	Rak et al.	.....	D14/242

**FOREIGN PATENT DOCUMENTS**

GB	2085406	11/1999
JP	872595	7/1993

**OTHER PUBLICATIONS**

U.S. Design patent application Ser. No. 29/132,272 filed Nov. 7, 2000.\*

\* cited by examiner

*Primary Examiner*—Kay H. Chin

(74) *Attorney, Agent, or Firm*—Rader, Fishman & Grauer, PLLC

(57) **CLAIM**

The ornamental design for an interface unit for computer, as shown and described.

**DESCRIPTION**

FIG. 1 is a front elevational view of an interface unit for computer showing my design;  
 FIG. 2 is a rear elevational view thereof;  
 FIG. 3 is a left side elevational view thereof;  
 FIG. 4 is a right side elevational view thereof;  
 FIG. 5 is a top plan view thereof;  
 FIG. 6 is a bottom plan view thereof;  
 FIG. 7 is an enlarged left side elevational view thereof;  
 FIG. 8 is an enlarged right side elevational view thereof;  
 and,  
 FIG. 9 is a perspective view thereof.

**1 Claim, 4 Drawing Sheets**

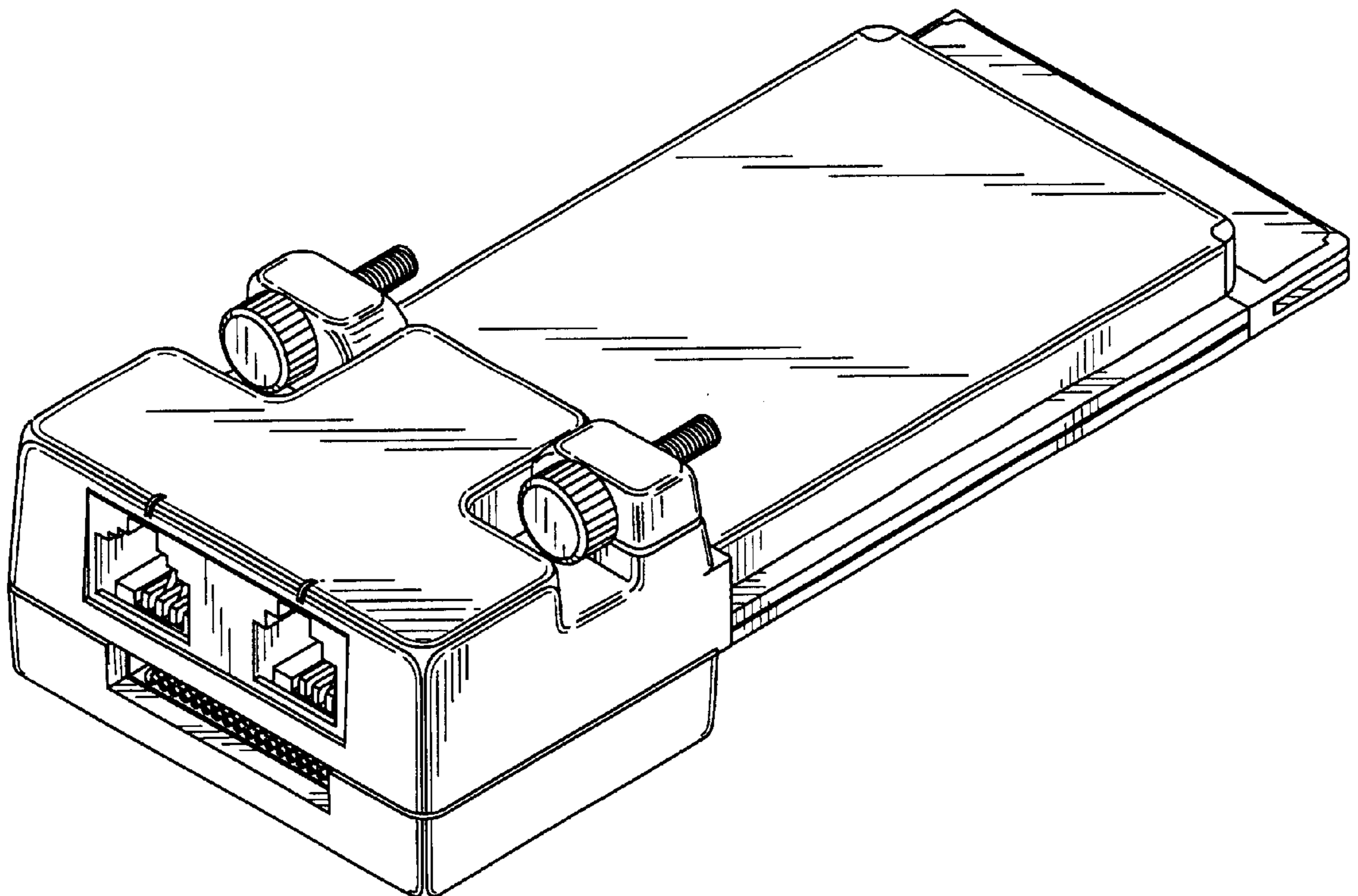

FIG. 1

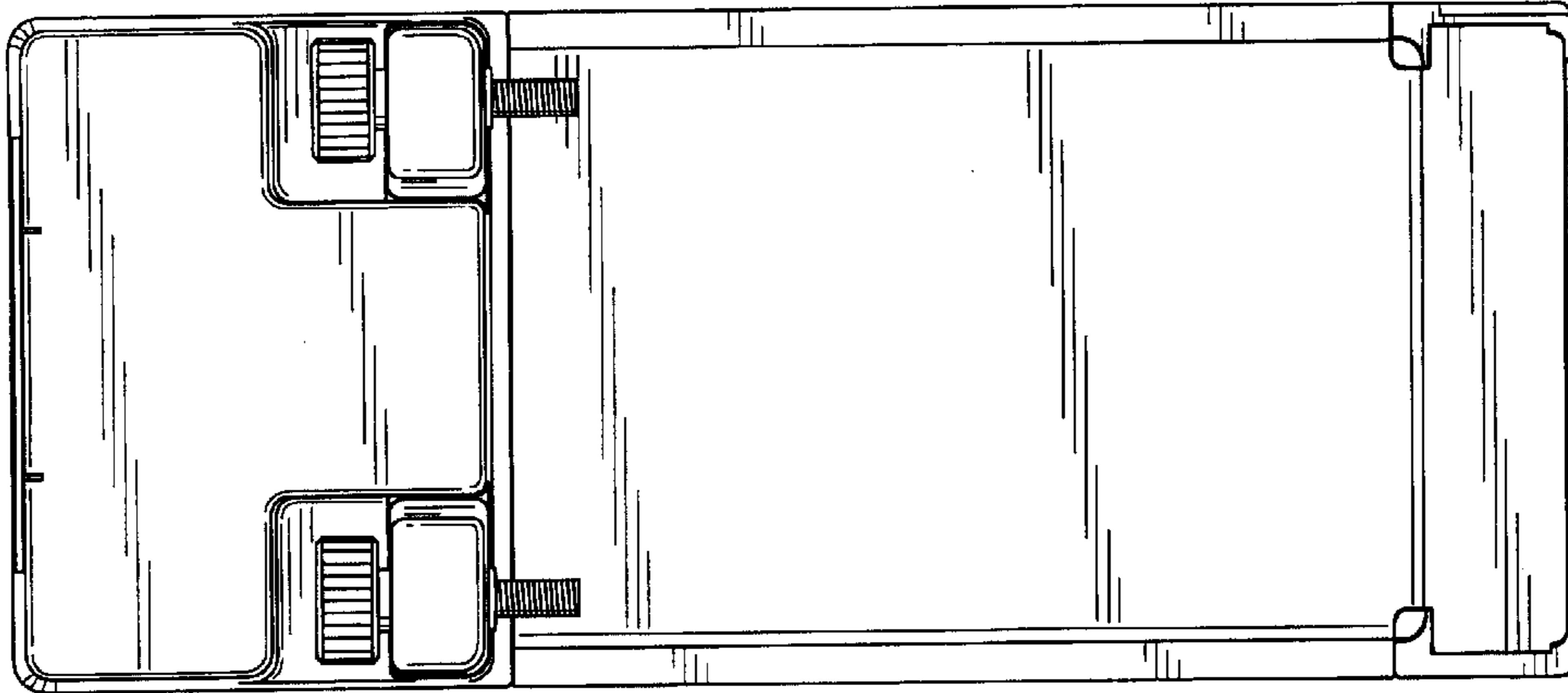

FIG. 2

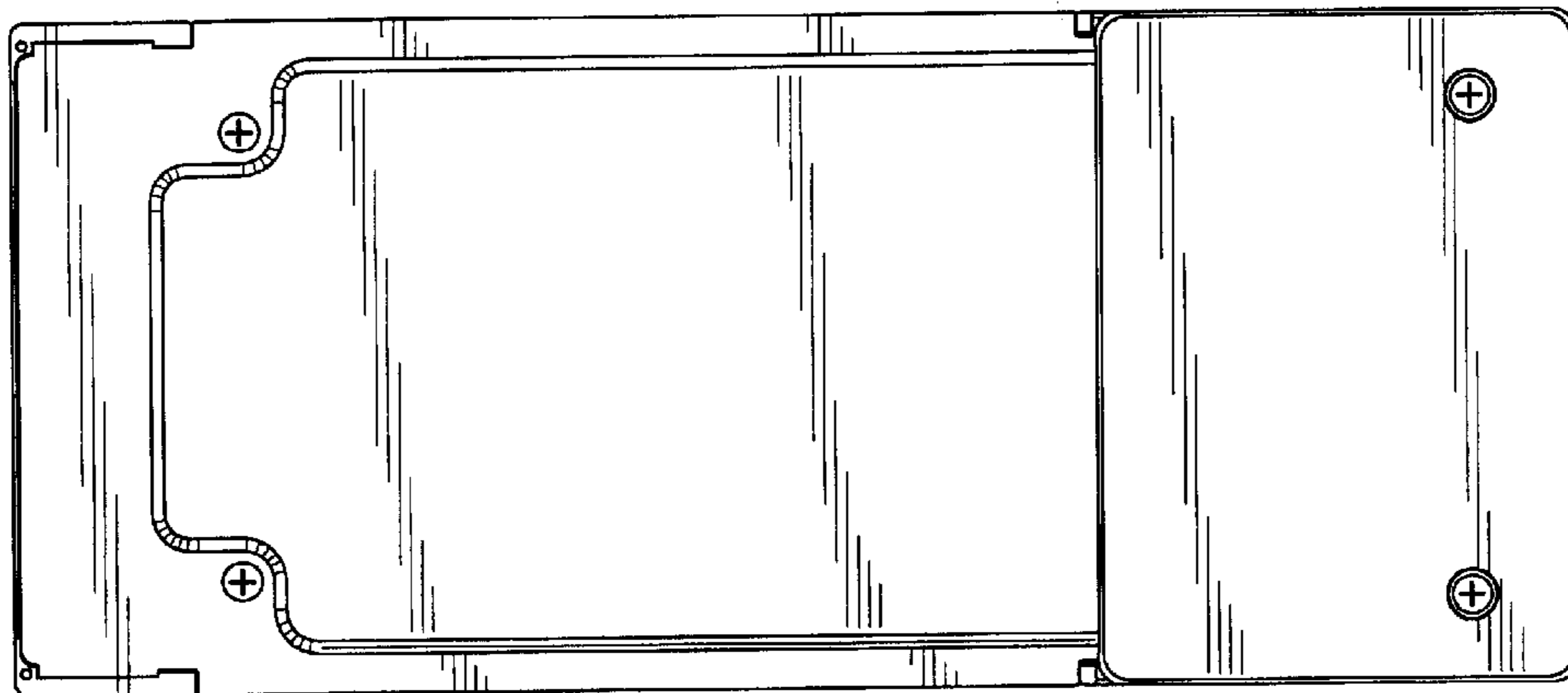

FIG. 3

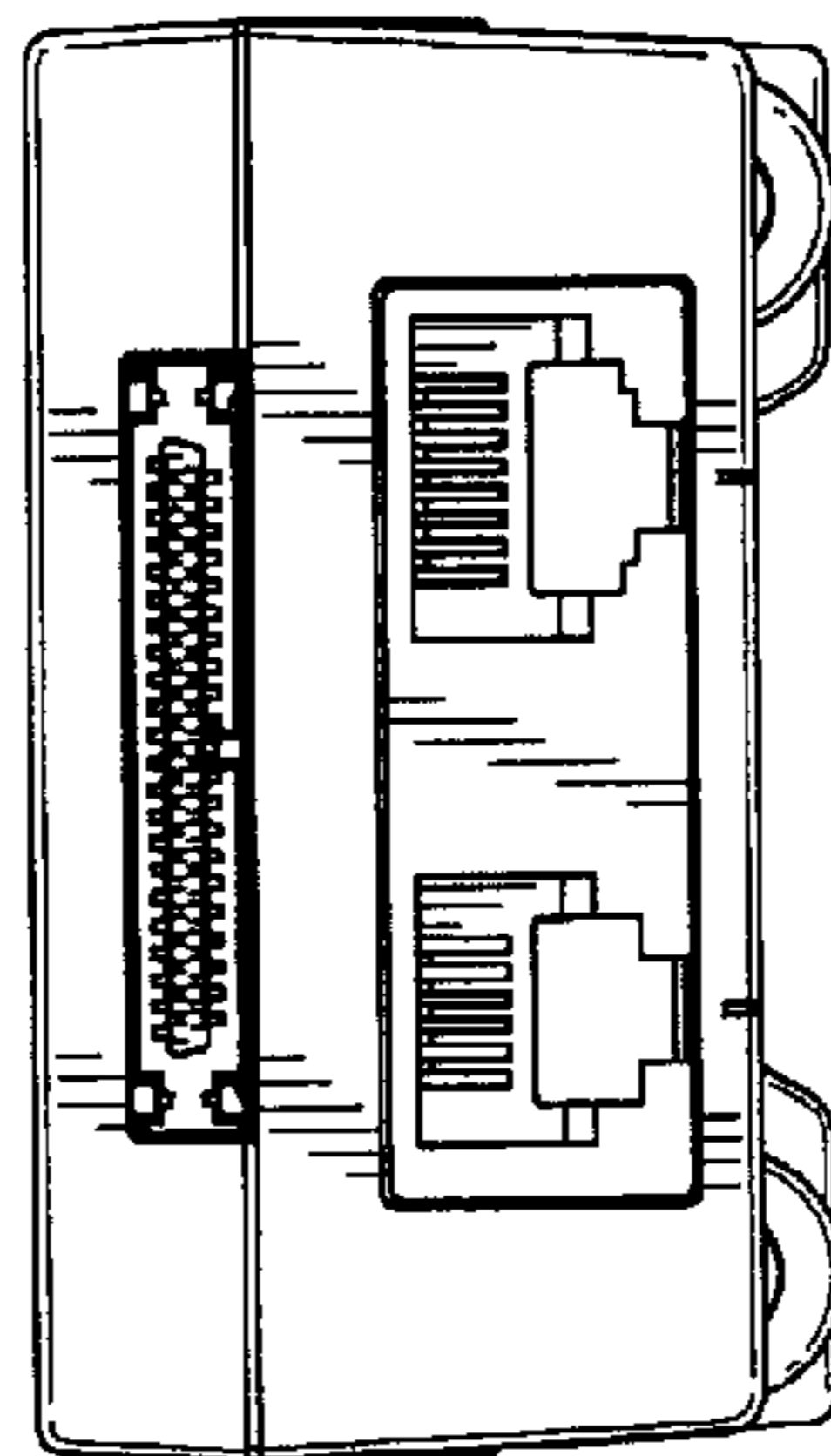

FIG. 4

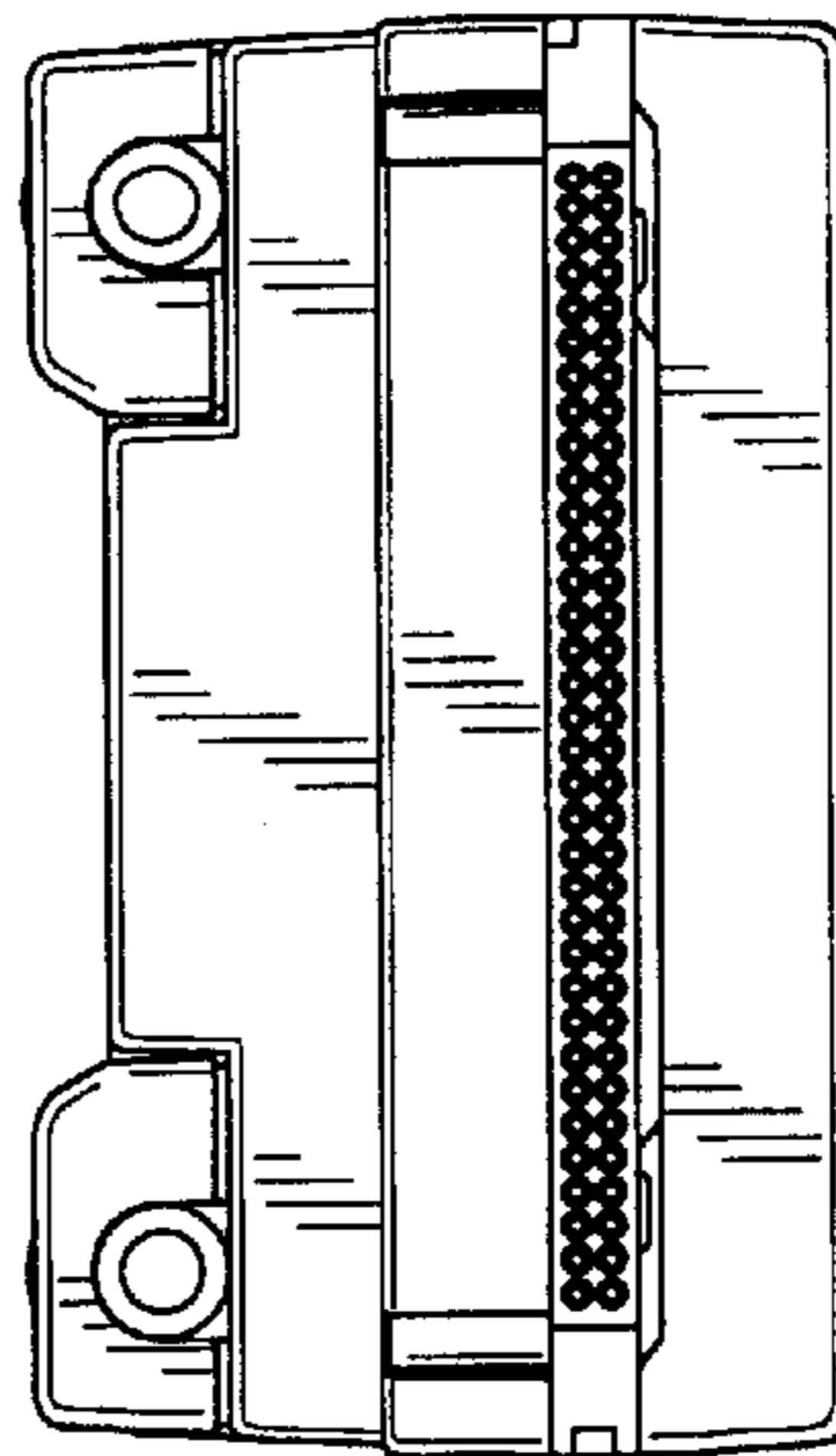

FIG. 5

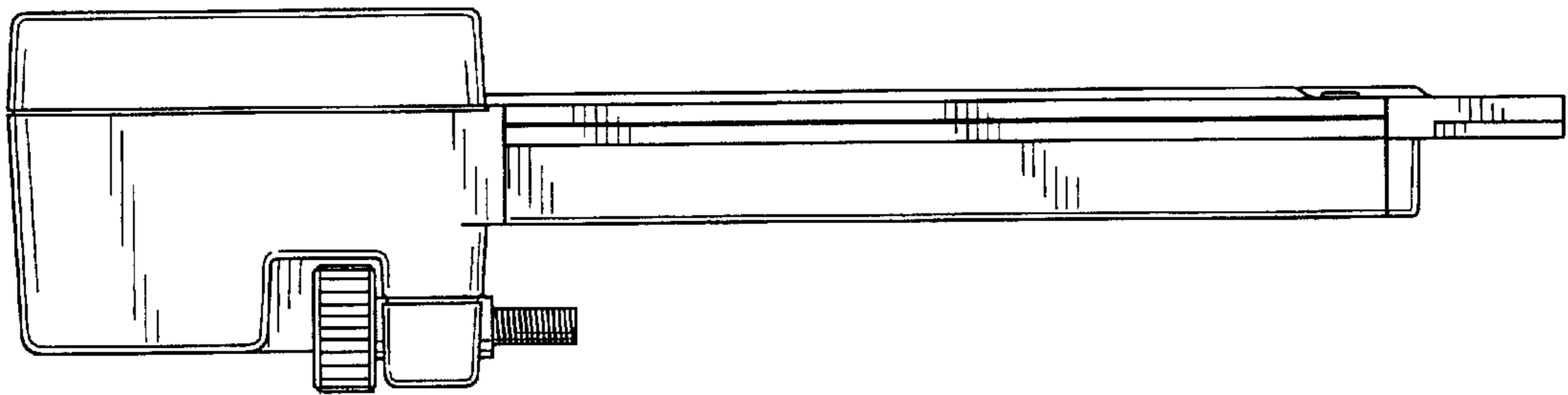

FIG. 6

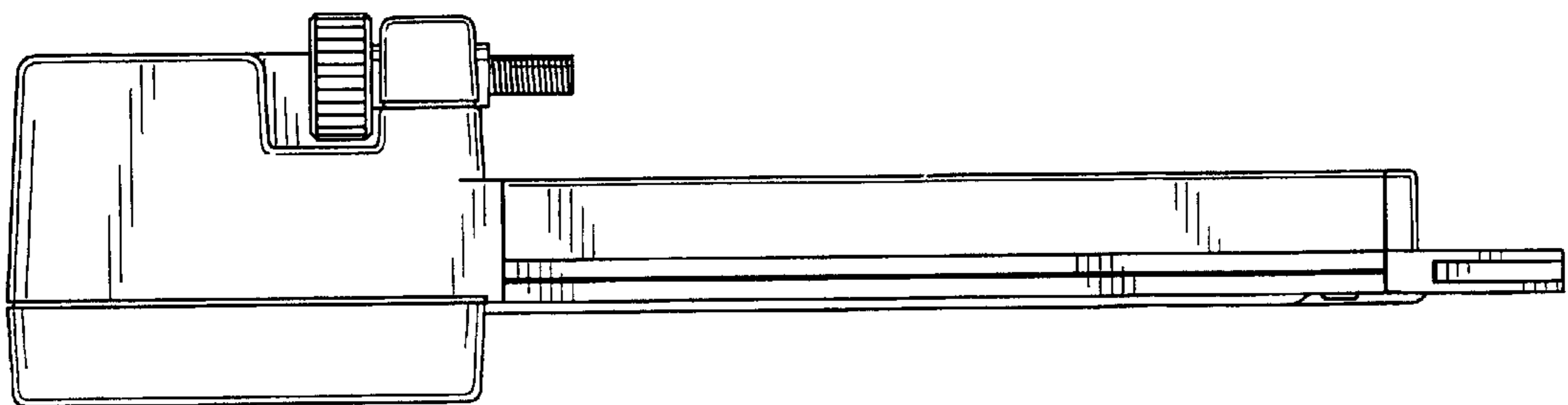

FIG. 7

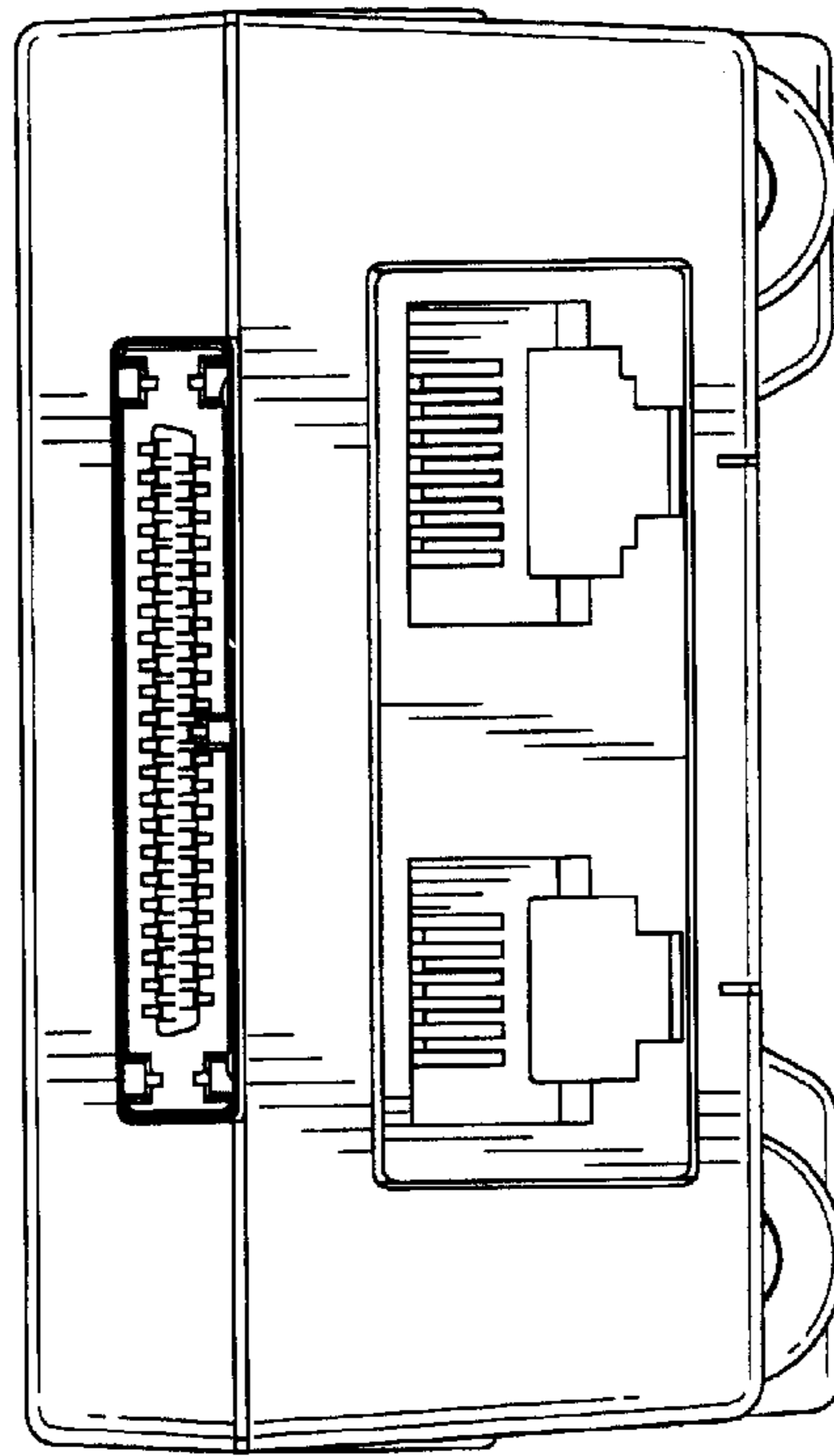

FIG. 8

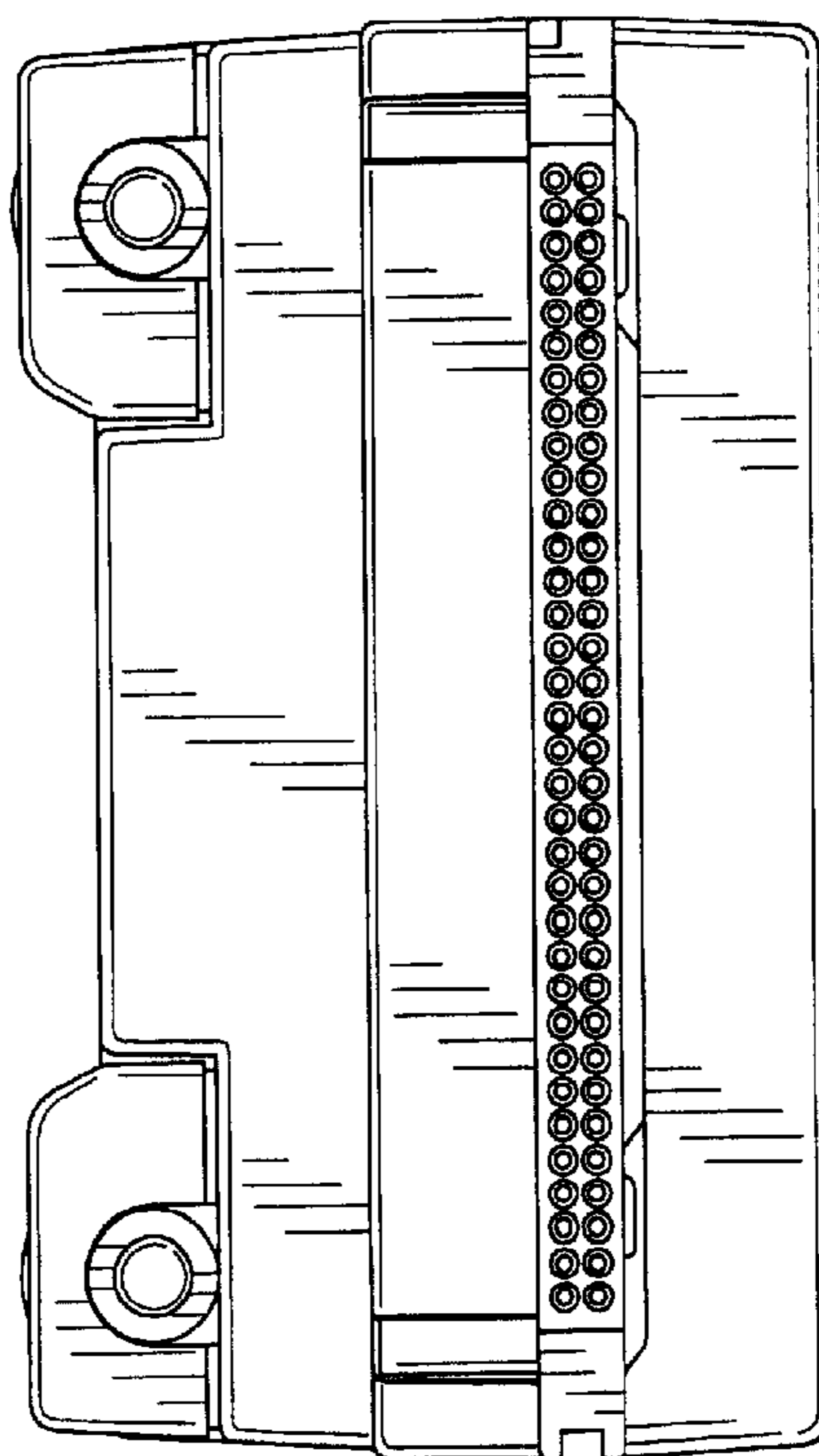

FIG. 9

