



US00D465345S

(12) **United States Design Patent**
Ma

(10) **Patent No.:** **US D465,345 S**

(45) **Date of Patent:** **** Nov. 12, 2002**

(54) **ARM CHAIR**

D420,523 S * 2/2000 Stumpf et al. D6/372
D453,079 S * 1/2002 Ma D6/366

(75) Inventor: **Chien-Shen Ma**, Wuchi (TW)

* cited by examiner

(73) Assignee: **The e Chair Company** (TW)

Primary Examiner—Gary D. Watson

(**) Term: **14 Years**

(74) *Attorney, Agent, or Firm*—Connolly Bove Lodge & Hutz, LLP

(21) Appl. No.: **29/144,222**

(57) **CLAIM**

(22) Filed: **Jun. 28, 2001**

The ornamental design for an arm chair, as shown and described.

(51) **LOC (7) Cl.** **06-01**

(52) **U.S. Cl.** **D6/372**

(58) **Field of Search** D6/334, 366, 369,
D6/371, 372, 373, 374, 379, 500, 501,
502; 297/445.1, 451.3

DESCRIPTION

(56) **References Cited**

U.S. PATENT DOCUMENTS

D377,431 S * 1/1997 Stumpf et al. D6/500
D386,023 S * 11/1997 Stumpf et al. D6/500
D402,128 S * 12/1998 Wilson D6/372
D416,705 S * 11/1999 Kaczmarek D6/372

FIG. 1 is a perspective view of for an arm chair showing my new design;
FIG. 2 is a front elevational view thereof;
FIG. 3 is a rear elevational view thereof;
FIG. 4 is a right side elevational view thereof;
FIG. 5 is a left side elevational view thereof;
FIG. 6 is a top plan view thereof; and,
FIG. 7 is a bottom plan view thereof.

1 Claim, 4 Drawing Sheets

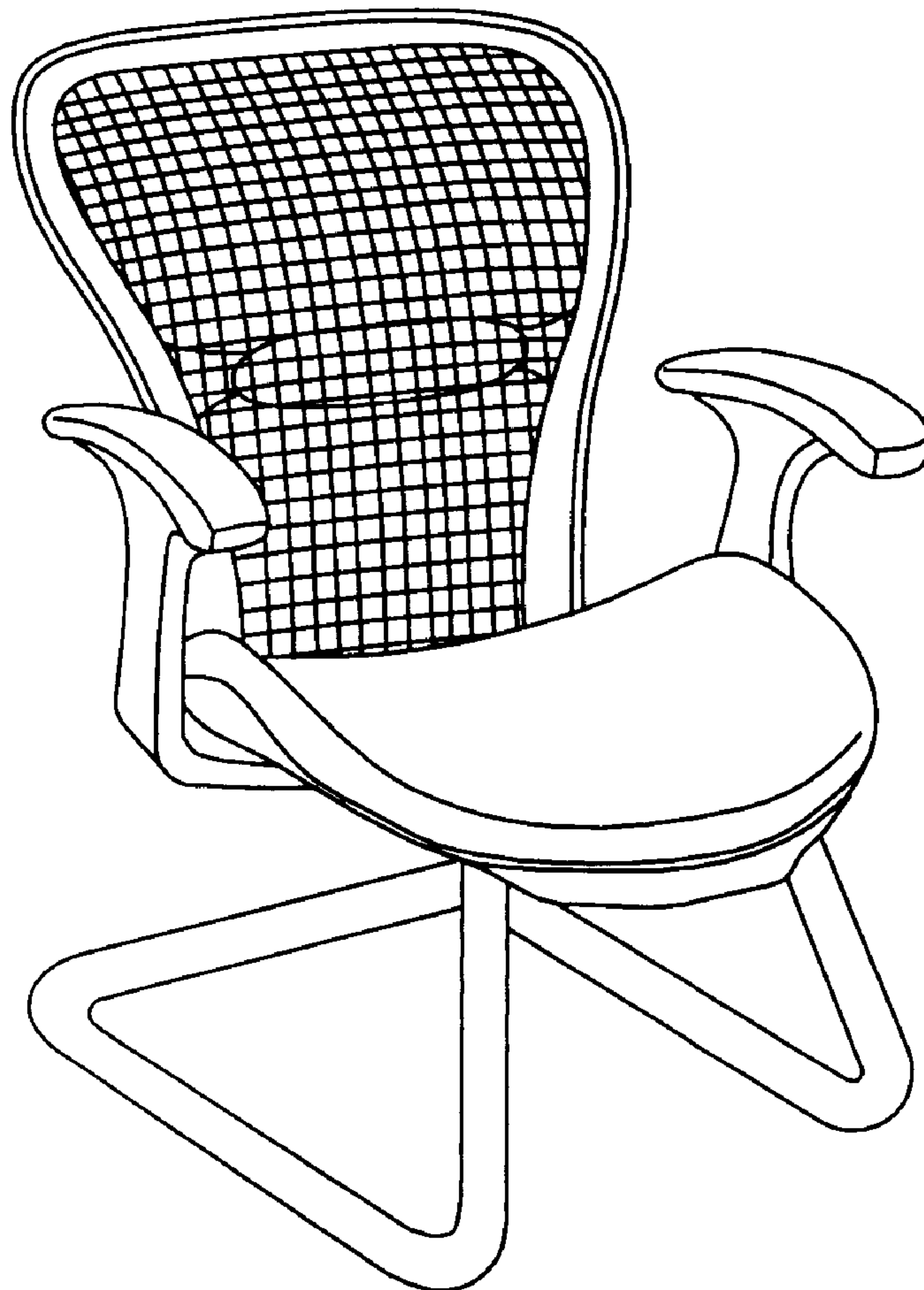

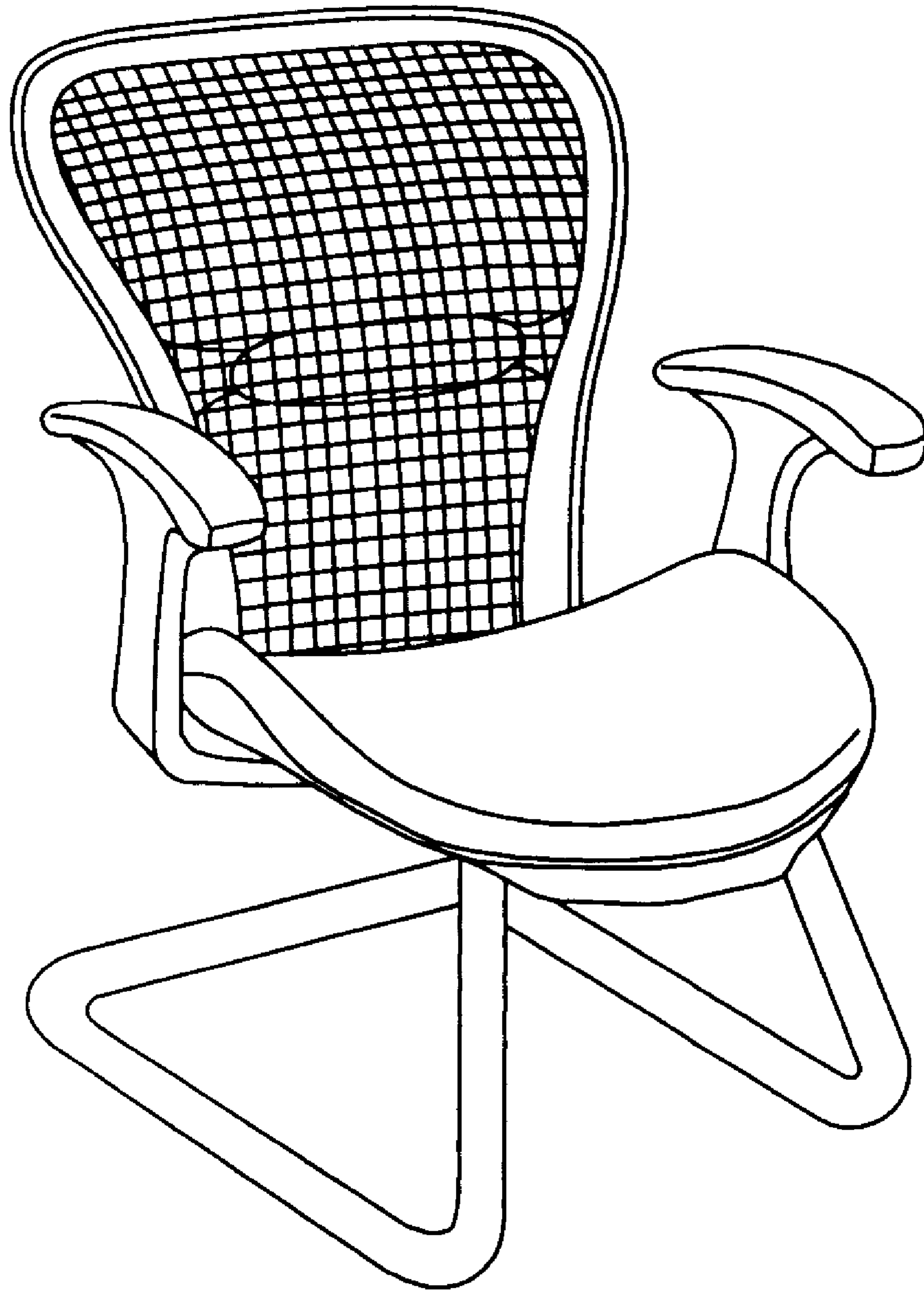

FIG. 1

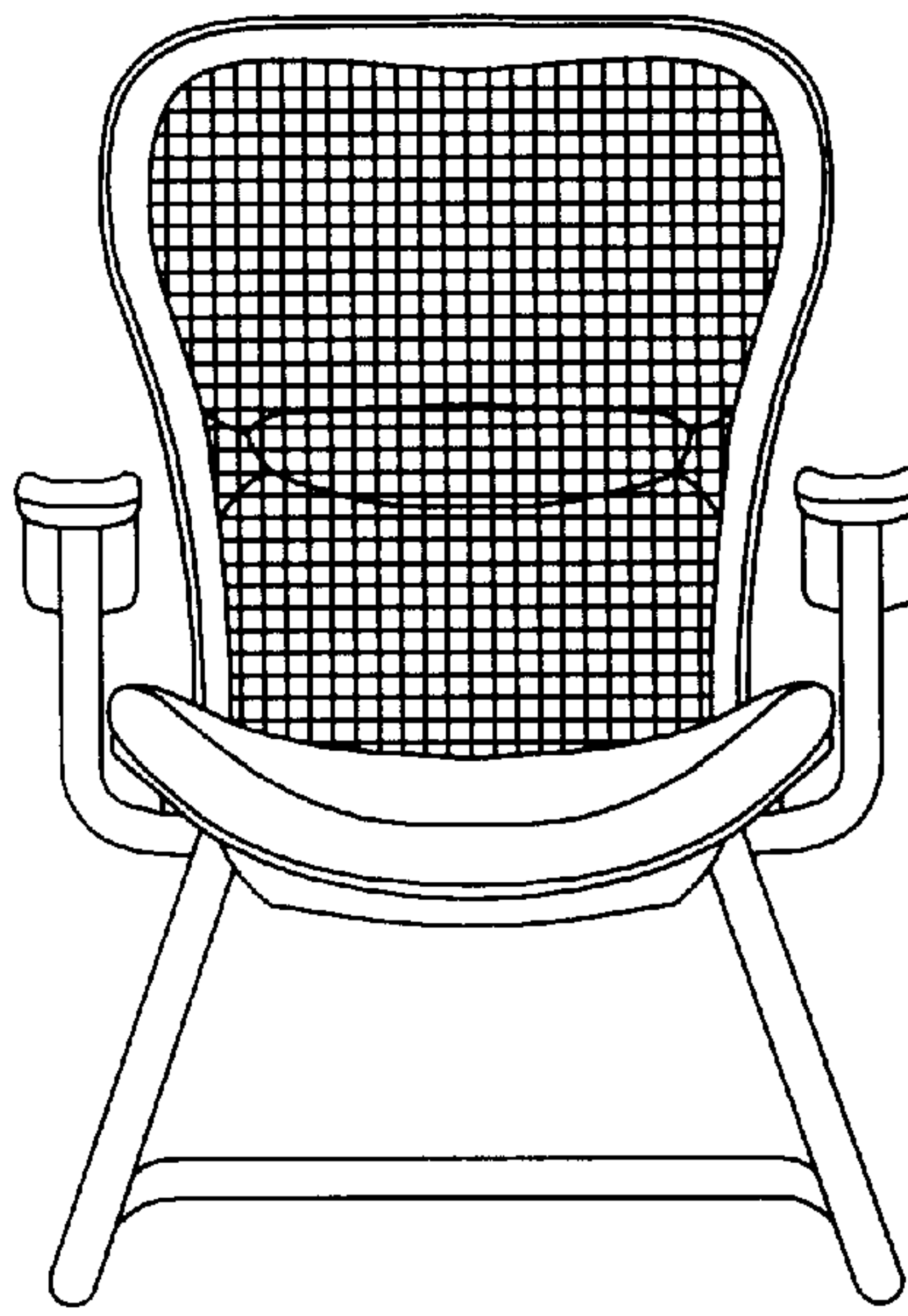

FIG. 2

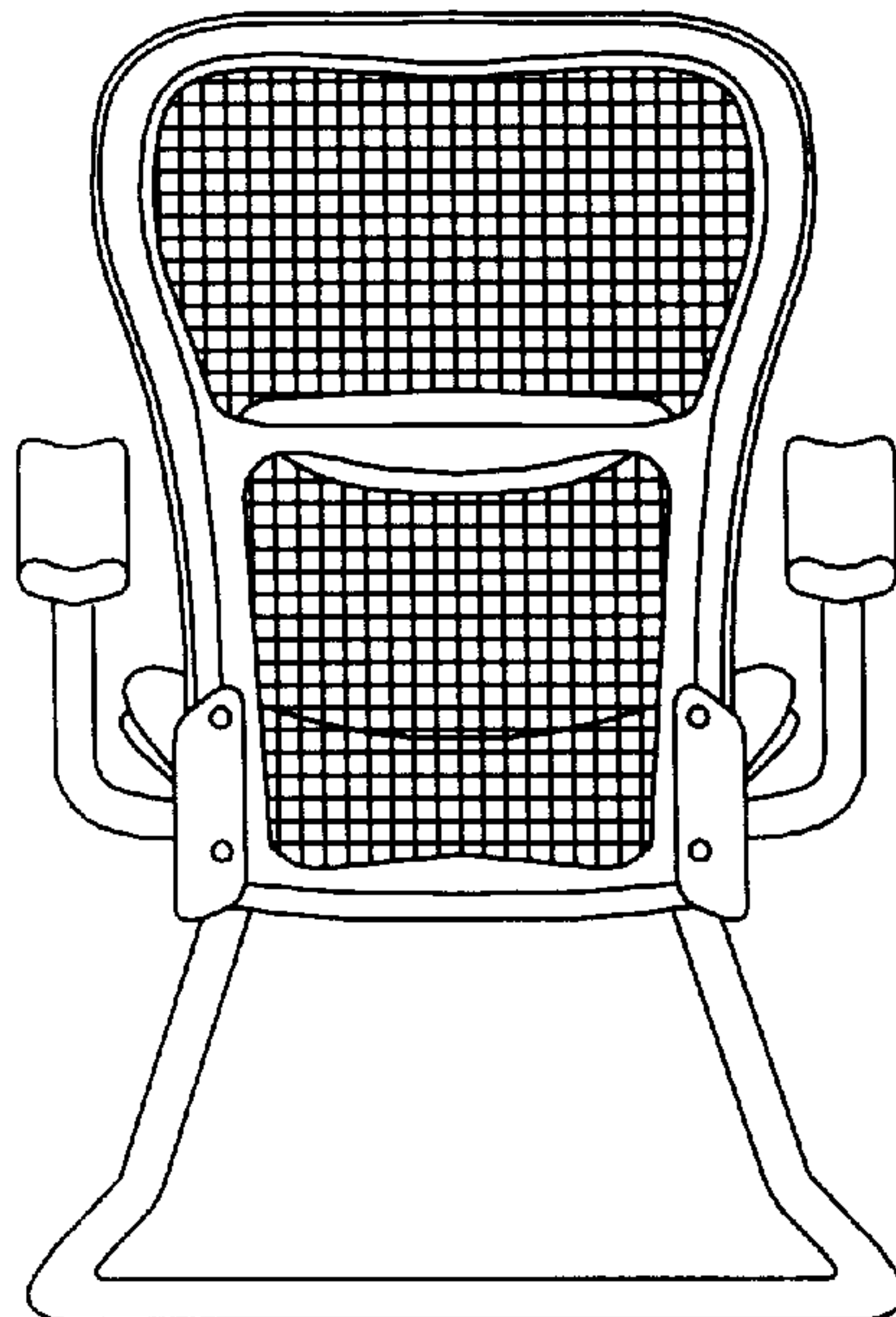

FIG. 3

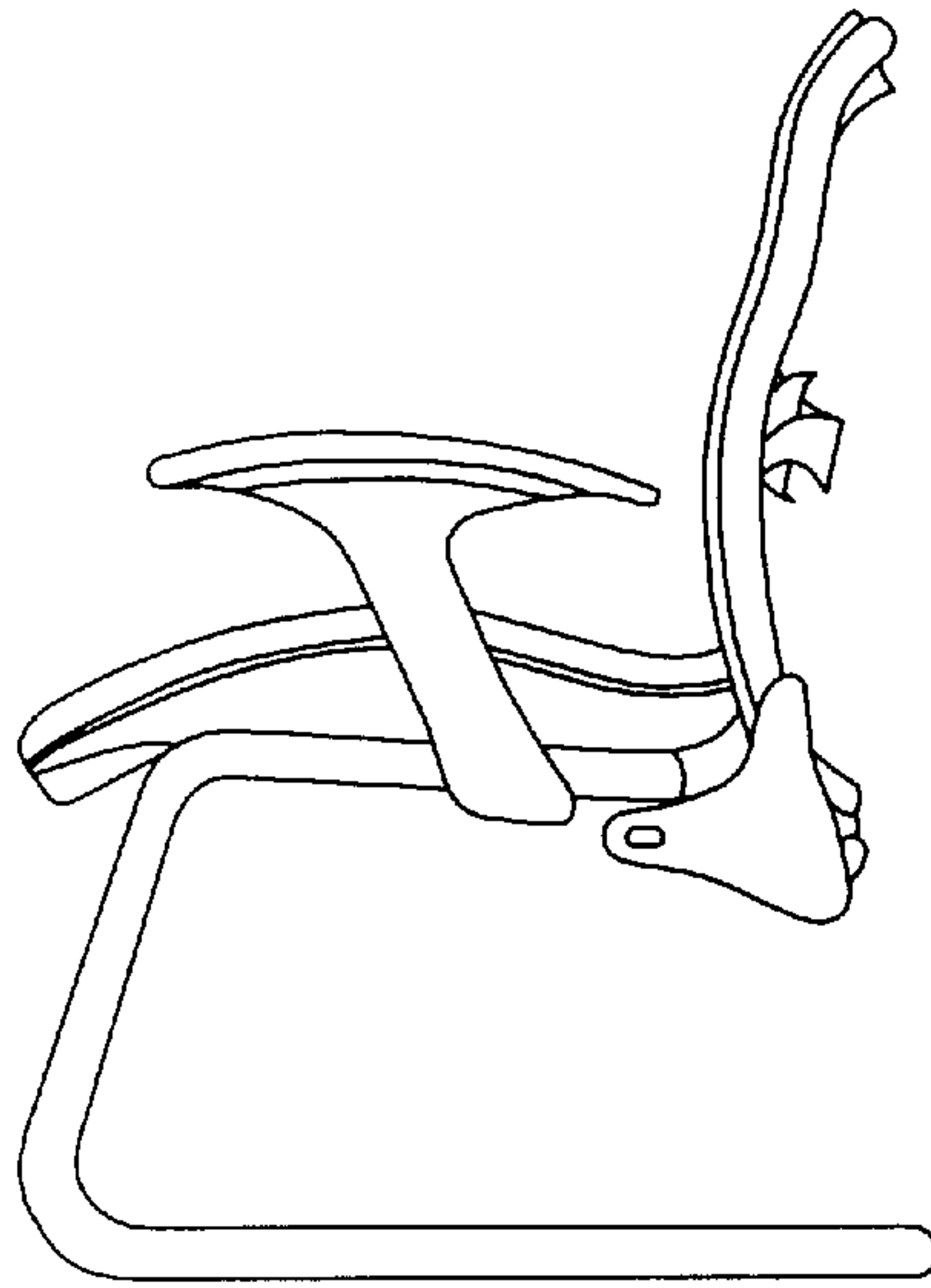

FIG. 4

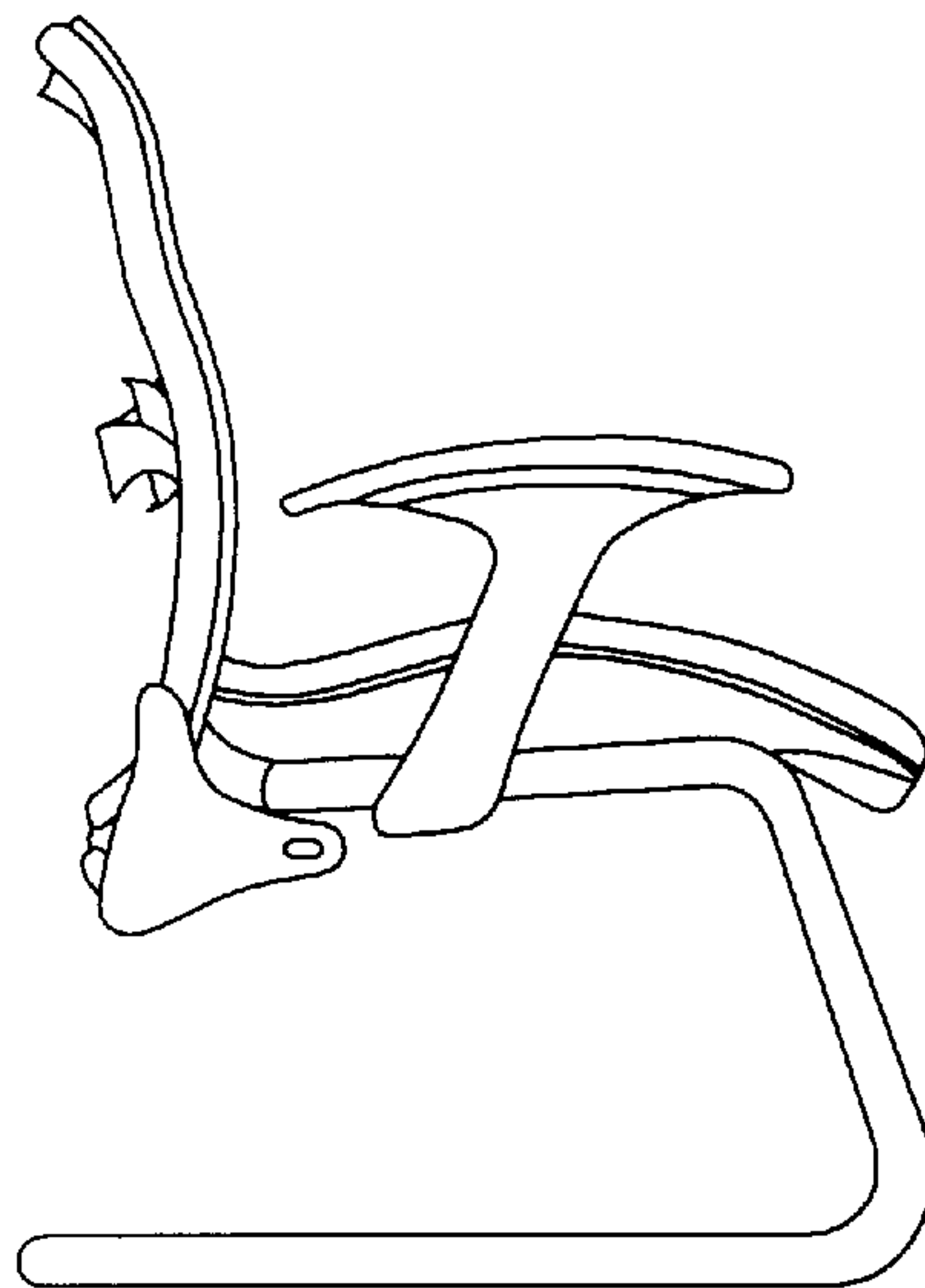

FIG. 5

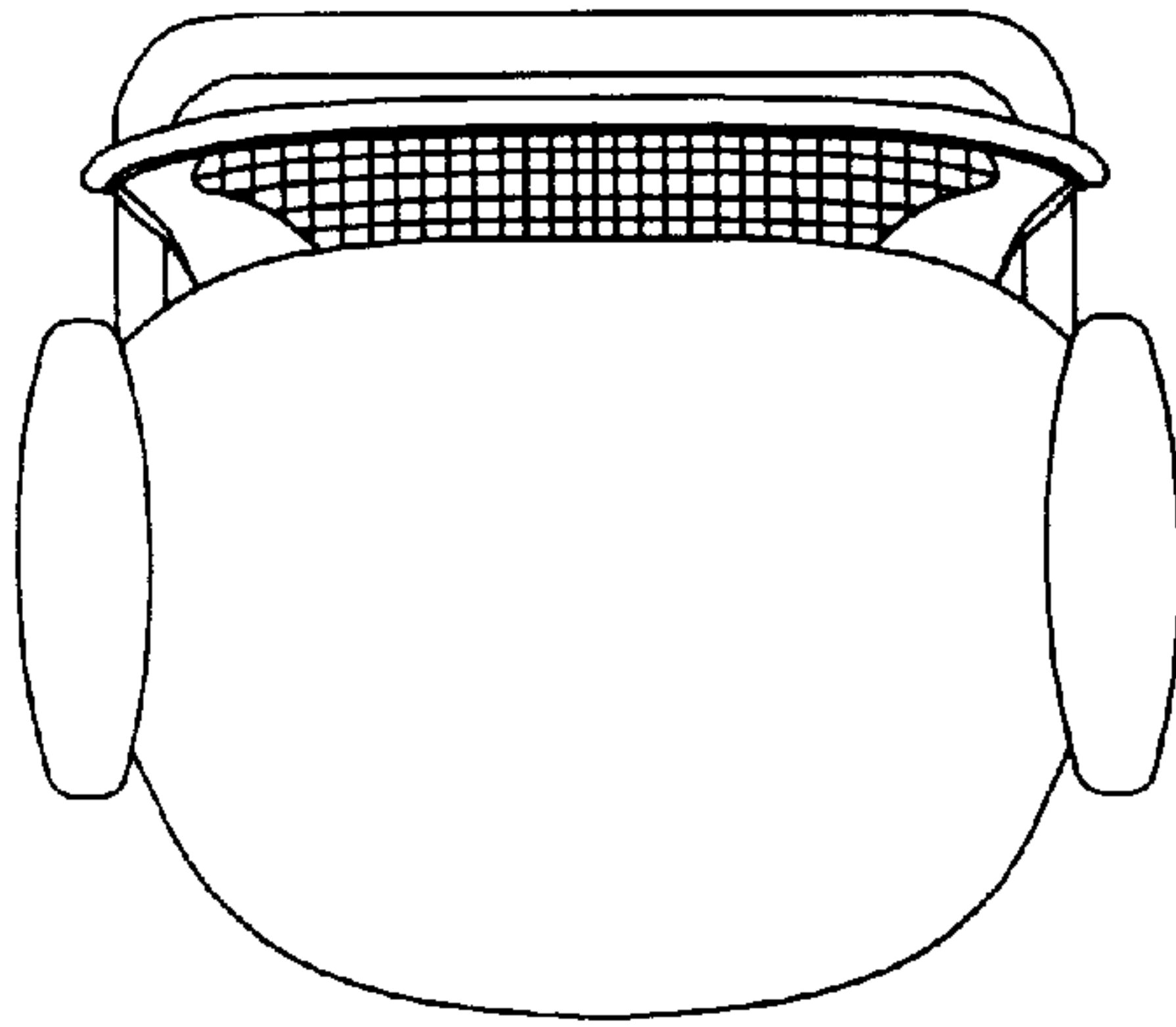

FIG. 6

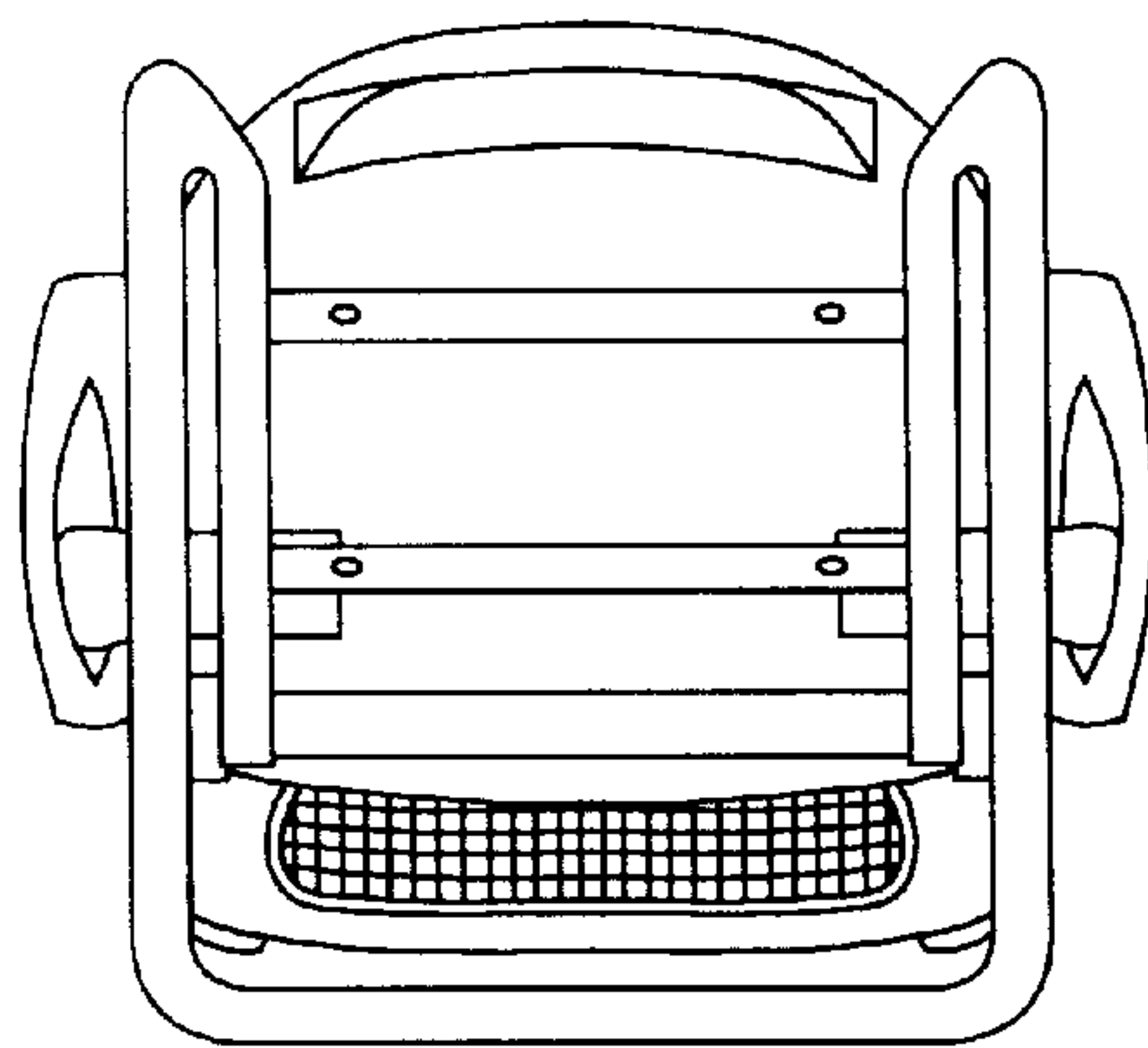

FIG. 7