

US00D465083S

(12) **United States Design Patent**
Clark

(10) **Patent No.:** **US D465,083 S**

(45) **Date of Patent:** **** Nov. 5, 2002**

(54) **GOLF CLUB HOLDER**

(76) Inventor: **Jerry L. Clark**, 5106 S. Farm/Market Rd. 14, Hawkins, TX (US) 75765

(**) Term: **14 Years**

(21) Appl. No.: **29/157,803**

(22) Filed: **Mar. 26, 2002**

(51) **LOC (7) Cl.** **03-01**

(52) **U.S. Cl.** **D3/221**

(58) **Field of Search** D3/221, 215, 224, D3/228, 320; D21/796; 224/918, 919, 914, 247, 667, 678; 206/315.2; 24/3.1

(56) **References Cited**

U.S. PATENT DOCUMENTS

| | | | | | | |
|-----------|---|---|---------|---------------|-------|---------|
| 2,589,126 | A | * | 3/1952 | Payne | | 224/247 |
| 4,100,652 | A | * | 7/1978 | Carlson | | 24/3.1 |
| 4,915,279 | A | | 4/1990 | Galbraith | | 224/230 |
| D316,484 | S | * | 4/1991 | Kounis et al. | | D3/221 |
| D338,048 | S | * | 8/1993 | Finley | | D21/796 |
| D348,712 | S | * | 7/1994 | Parker, Jr. | | D21/796 |
| D364,912 | S | * | 12/1995 | Sowers | | D21/796 |

* cited by examiner

Primary Examiner—Catherine R. Oliver
(74) *Attorney, Agent, or Firm*—C. W. Alworth

(57) **CLAIM**

The ornamental design for a golf club holder, as shown and described.

DESCRIPTION

FIG. 1, is a perspective view of a golf club holder, showing my new design.
 FIG. 2, is an exploded perspective view of a golf club holder.
 FIG. 3, is a top view of a golf club holder.
 FIG. 4, is a bottom view of a golf club holder.
 FIG. 5, is a side view of a golf club holder, taken from the right hand side of FIG. 3.
 FIG. 6, is a side view of a golf club holder, taken from the left hand side of FIG. 3.
 FIG. 7, is a side view of a golf club holder, taken from the bottom side of FIG. 3; and,
 FIG. 8, is a side view of a golf club holder, taken from the top side of FIG. 3.

1 Claim, 8 Drawing Sheets

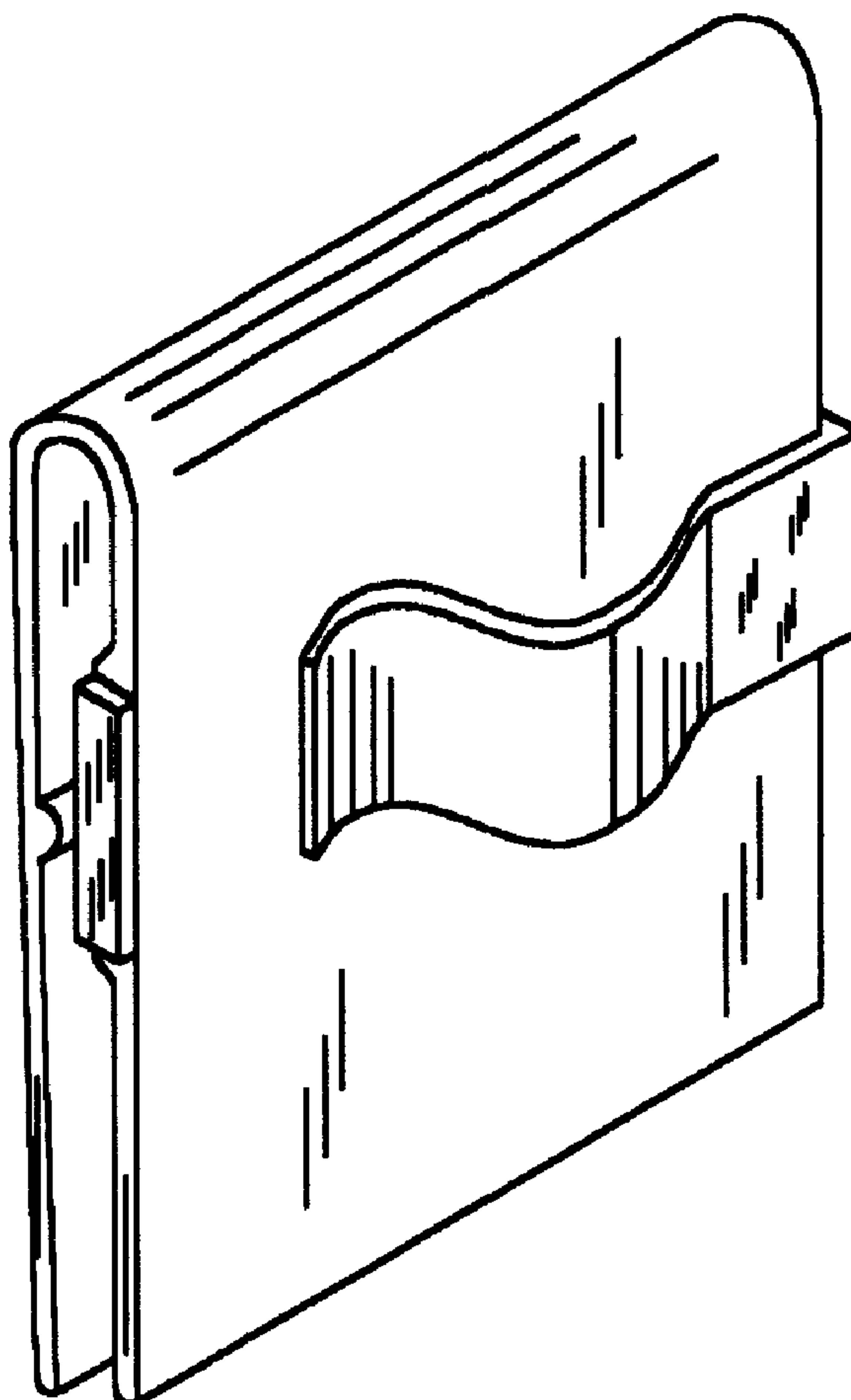

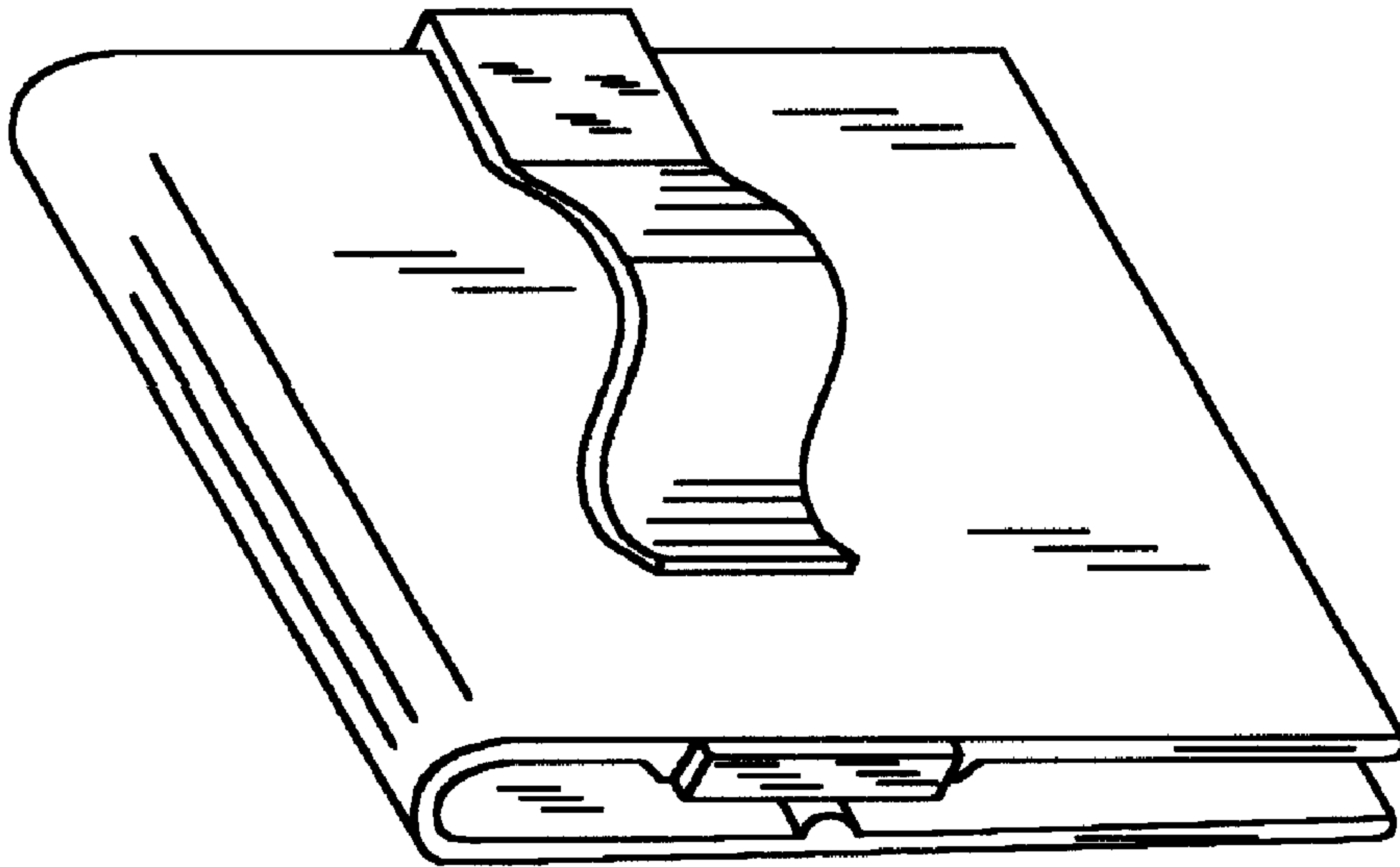

FIGURE 1

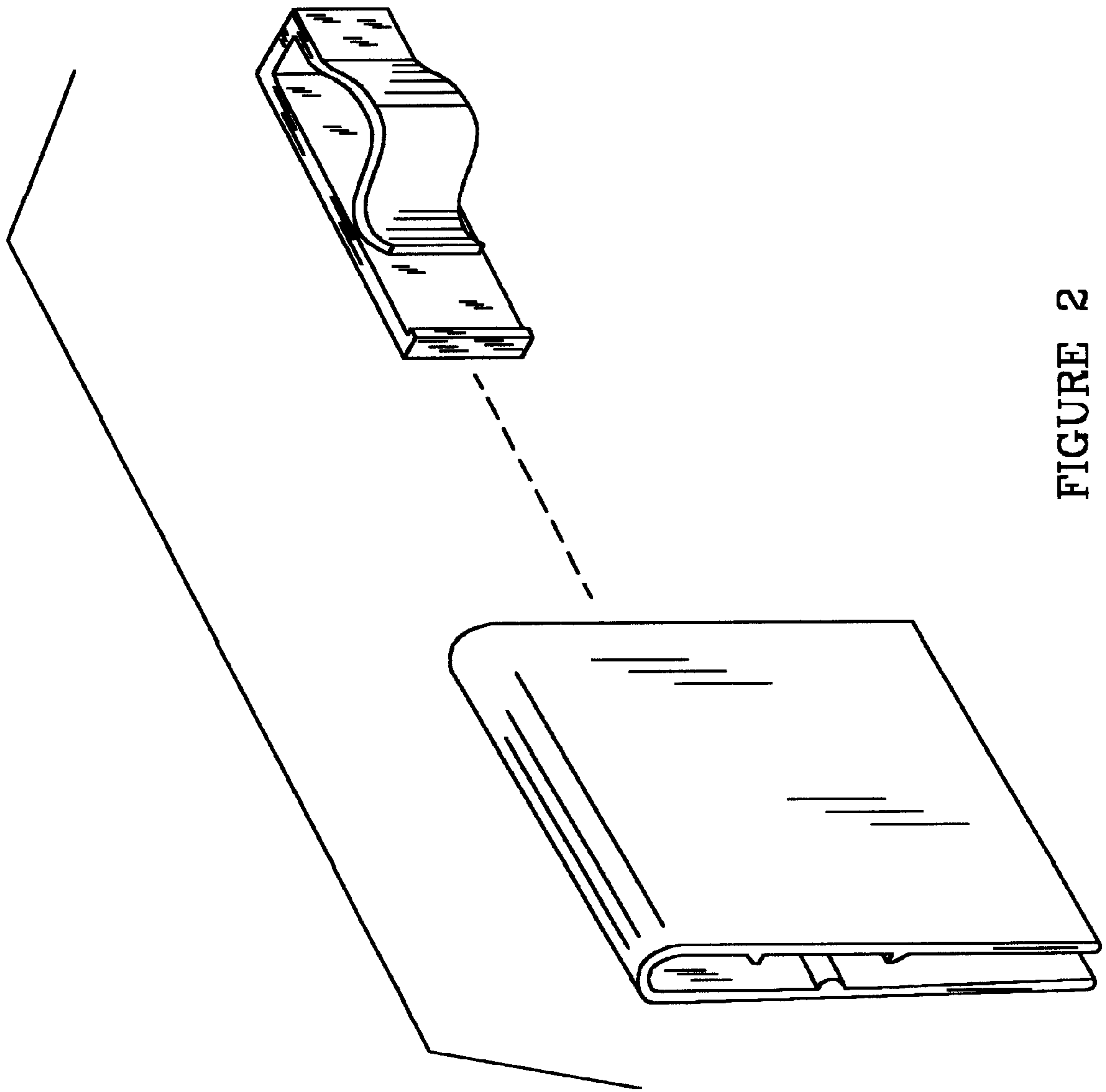

FIGURE 2

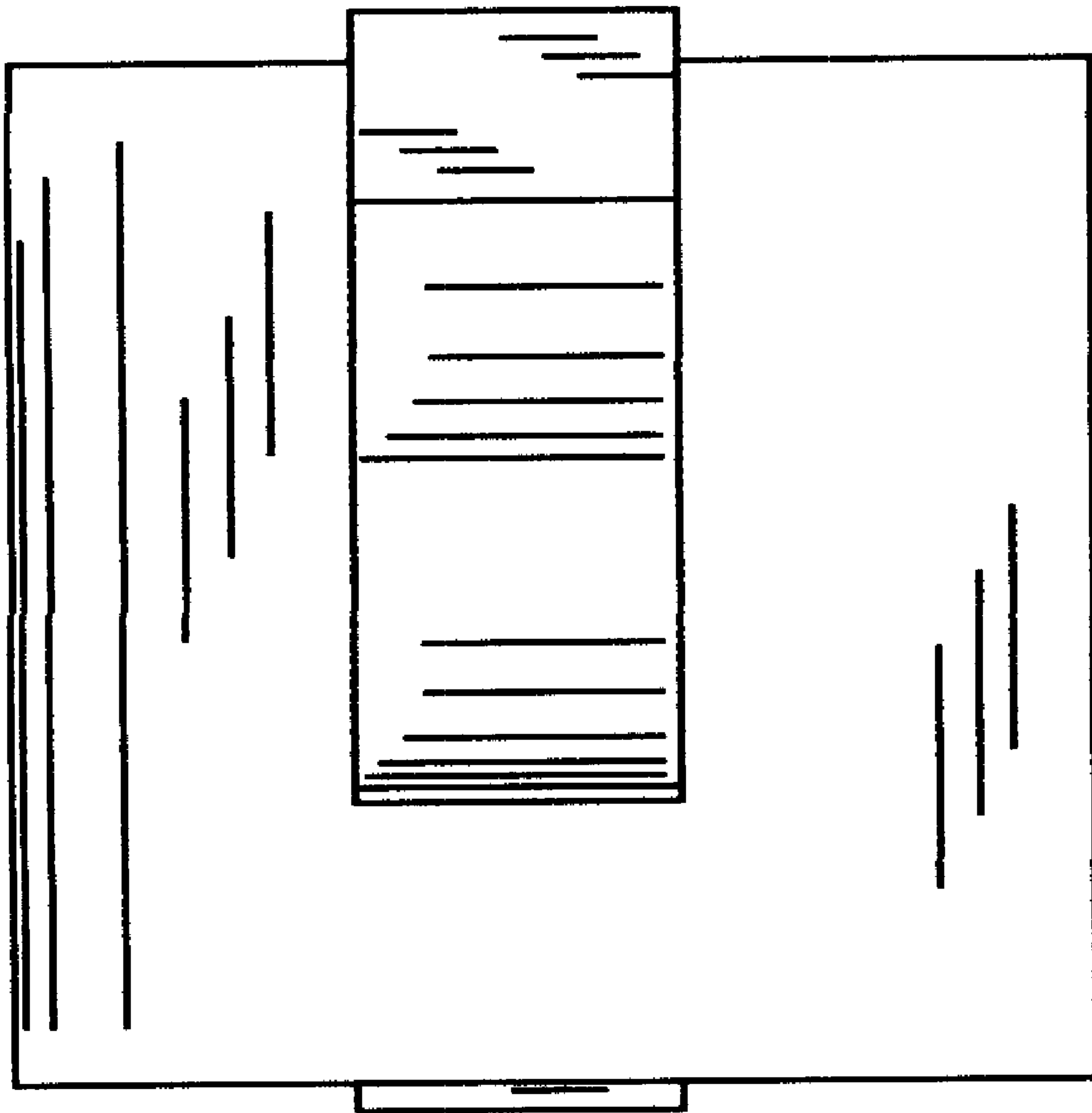

FIGURE 3

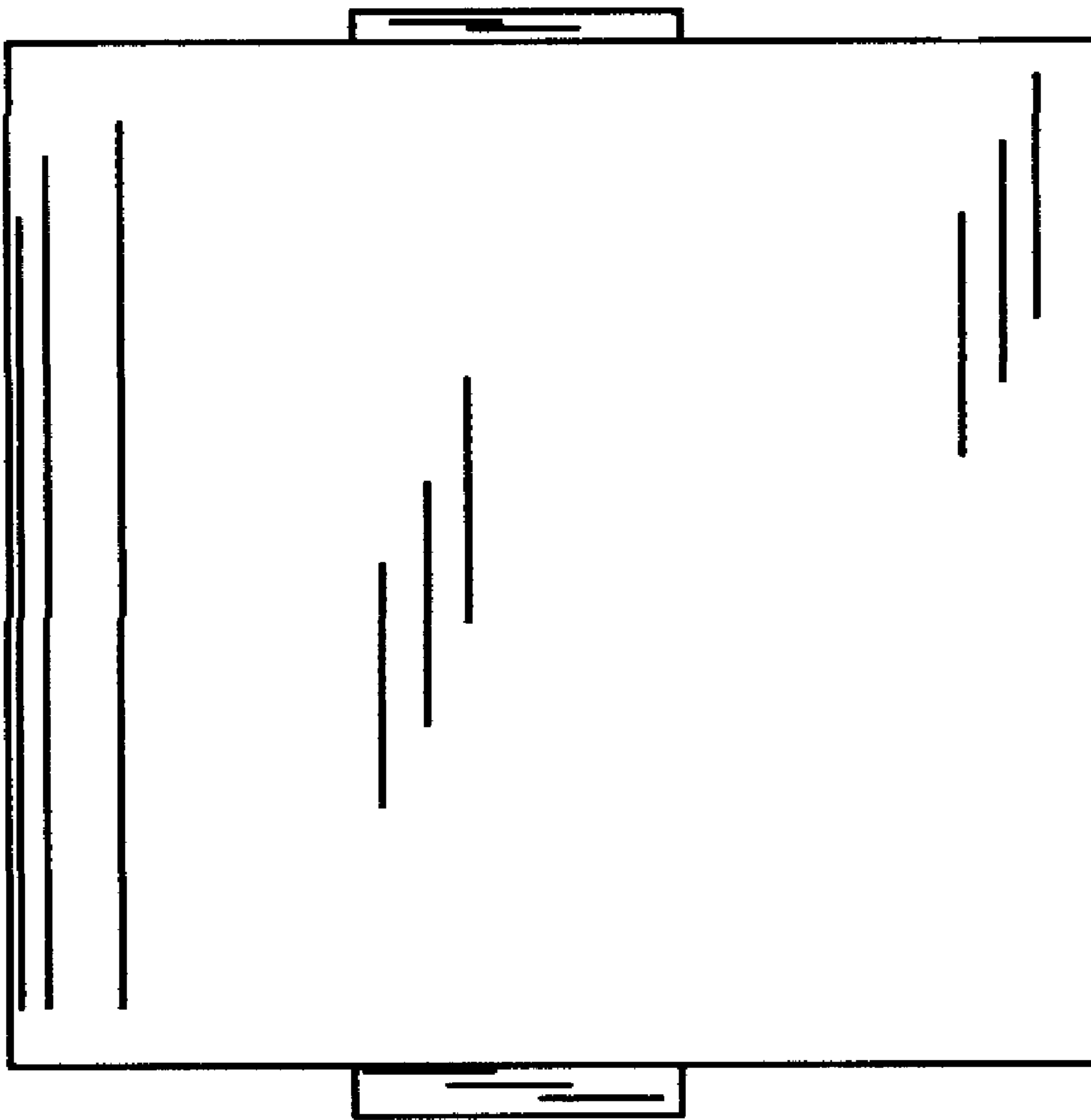

FIGURE 4

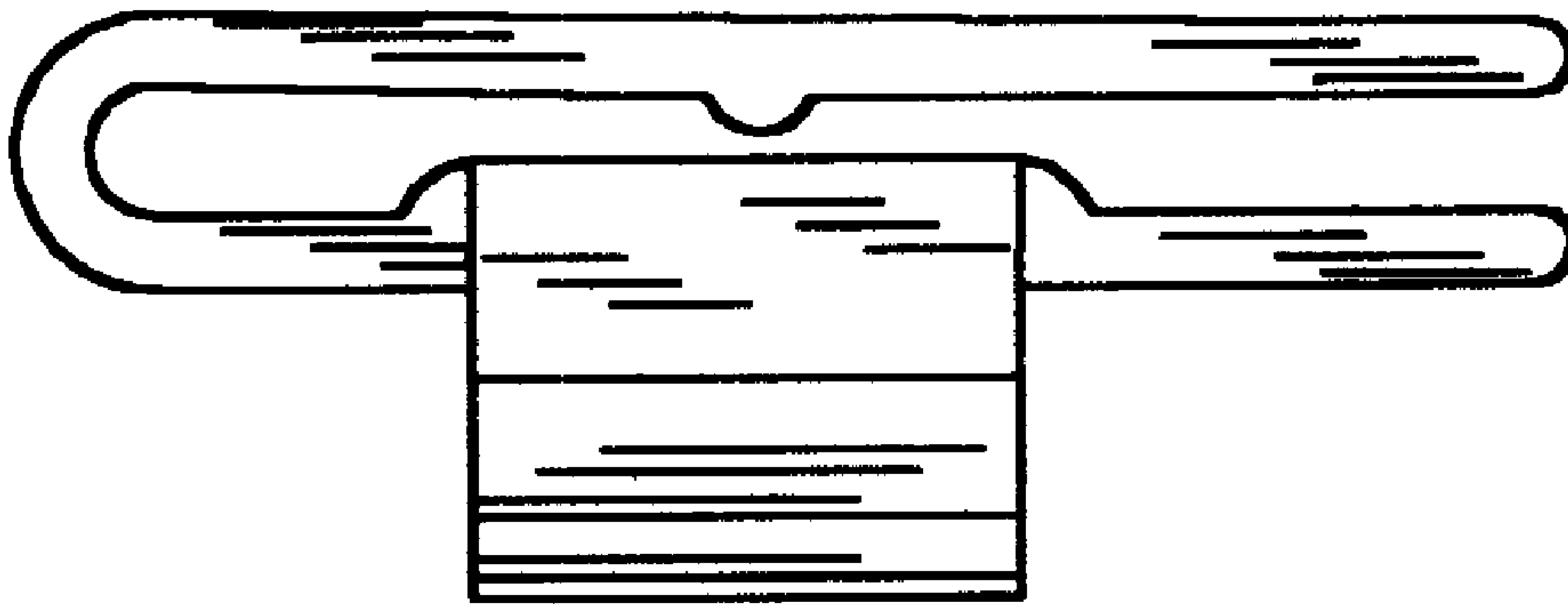

FIGURE 5

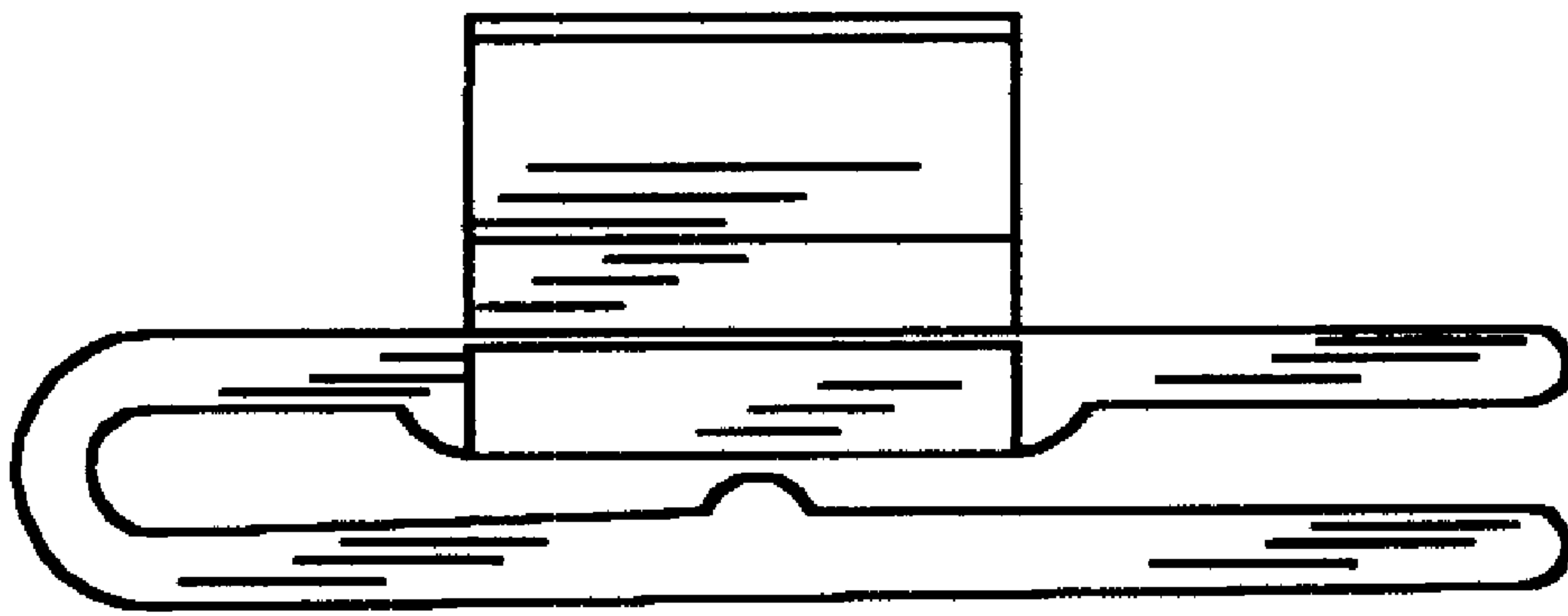

FIGURE 6

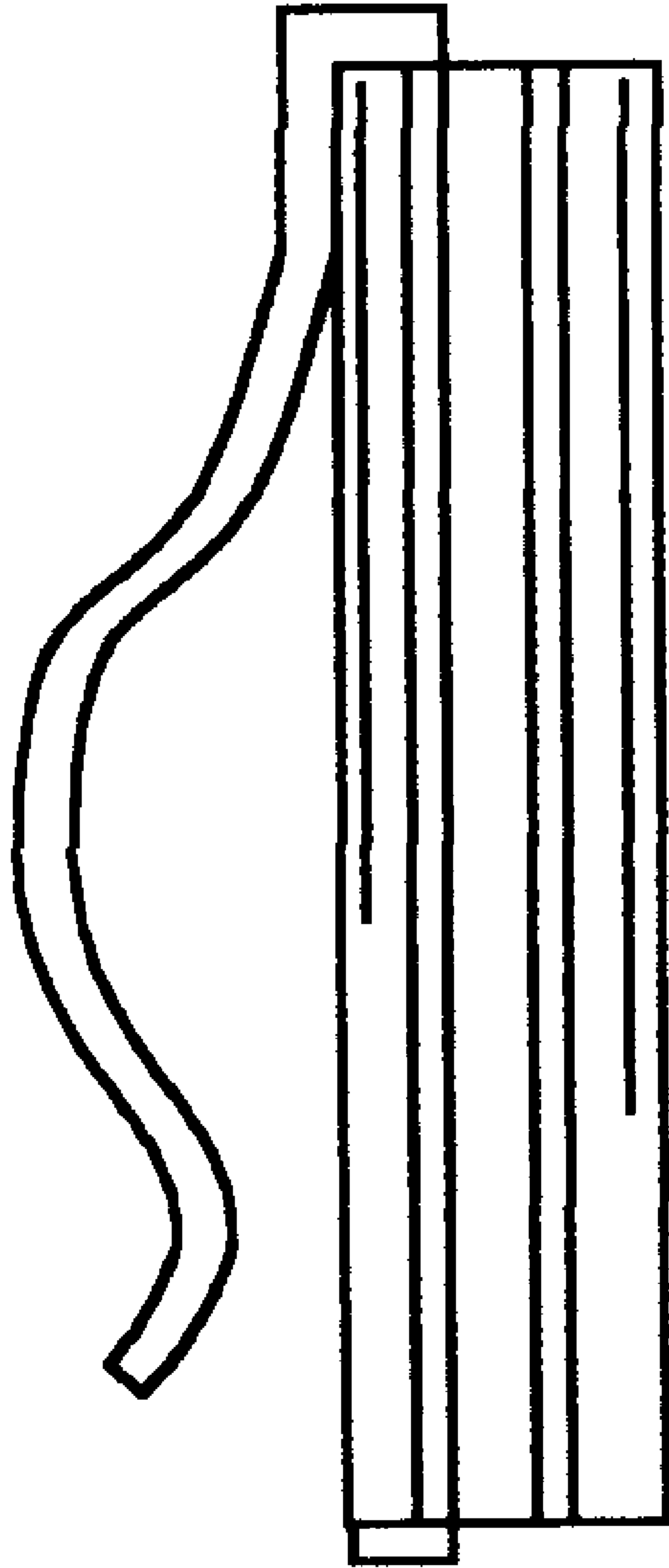

FIGURE 7

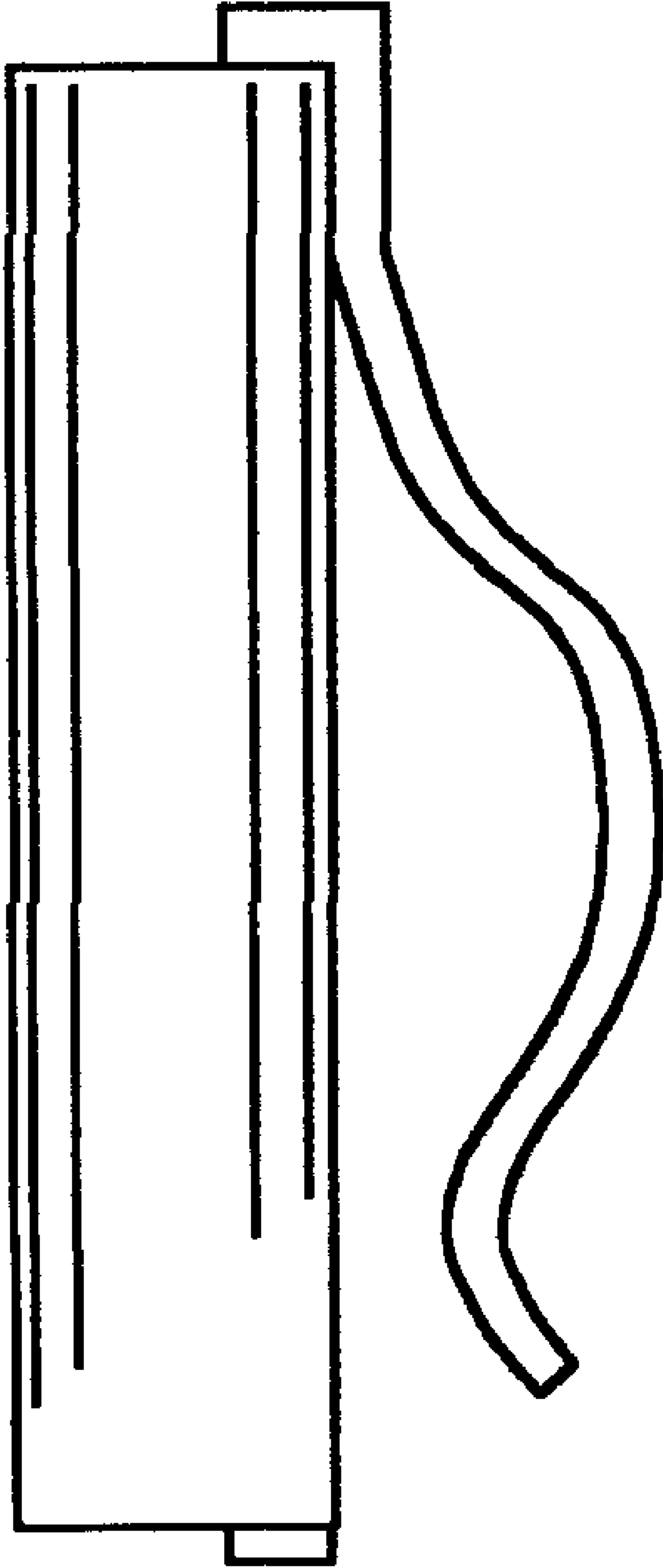

FIGURE 8