



US00D464963S

(12) **United States Design Patent**  
**Nishida**

(10) **Patent No.:** **US D464,963 S**

(45) **Date of Patent:** **\*\* Oct. 29, 2002**

(54) **PERSONAL DIGITAL ASSISTANT**

(75) **Inventor:** **Koji Nishida, Nara-ken (JP)**

(73) **Assignee:** **Sharp Kabushiki Kaisha, Osaka (JP)**

(\*\*) **Term:** **14 Years**

(21) **Appl. No.:** **29/156,641**

(22) **Filed:** **Mar. 6, 2002**

(30) **Foreign Application Priority Data**

Sep. 6, 2001 (JP) ..... 2001-026204

(51) **LOC (7) Cl.** ..... **14-02**

(52) **U.S. Cl.** ..... **D14/346**

(58) **Field of Search** ..... D14/341-346,  
D14/331; D18/1, 2, 7; 235/145 A, 145 R;  
341/22, 23; 345/156, 168, 169, 172, 173;  
349/12; 361/680-686; D10/65

(56) **References Cited**

**U.S. PATENT DOCUMENTS**

- D312,628 S 12/1990 Yokoi et al.
- D332,604 S 1/1993 Miyake et al.
- 5,218,187 A 6/1993 Koenck et al.
- D348,654 S 7/1994 Branck et al.
- D359,920 S 7/1995 Sakamoto
- D387,737 S 12/1997 Mizusugi et al.

- D402,572 S \* 12/1998 Han ..... D10/65
- D411,181 S \* 6/1999 Tamaki et al. .... D14/345
- D412,494 S \* 8/1999 Tamaki et al. .... D14/314
- D433,017 S 10/2000 Martinez
- D436,104 S \* 1/2001 Bhatia et al. .... D14/341
- D436,591 S \* 1/2001 Abston et al. .... D14/341
- D440,562 S \* 4/2001 Gottlieb et al. .... D14/341
- D442,156 S 5/2001 Lee
- D442,569 S 5/2001 Hanna et al.
- D454,349 S 3/2002 Makidera et al.

\* cited by examiner

*Primary Examiner*—Freda Nunn

(74) *Attorney, Agent, or Firm*—Nixon & Vanderhye PC

(57) **CLAIM**

The ornamental design for a personal digital assistant, as shown and described.

**DESCRIPTION**

FIG. 1 is a top, front and right side perspective view of a personal digital assistant according to my design; FIG. 2 is a front elevational view thereof; FIG. 3 is a rear elevational view thereof; FIG. 4 is a top plan view thereof; FIG. 5 is a bottom plan view thereof; FIG. 6 is a right side elevational view thereof; and, FIG. 7 is a left side elevational view thereof.

**1 Claim, 5 Drawing Sheets**

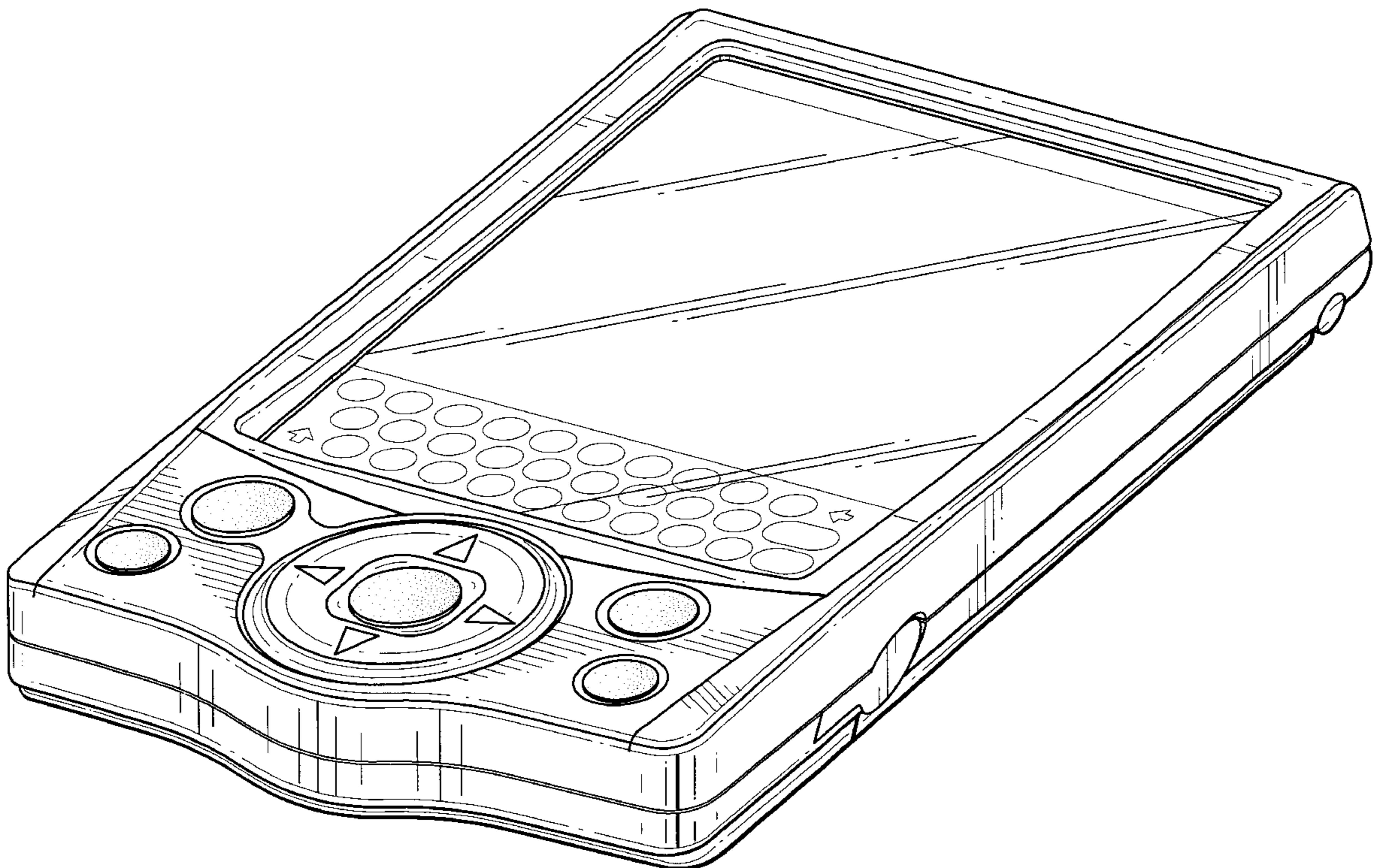

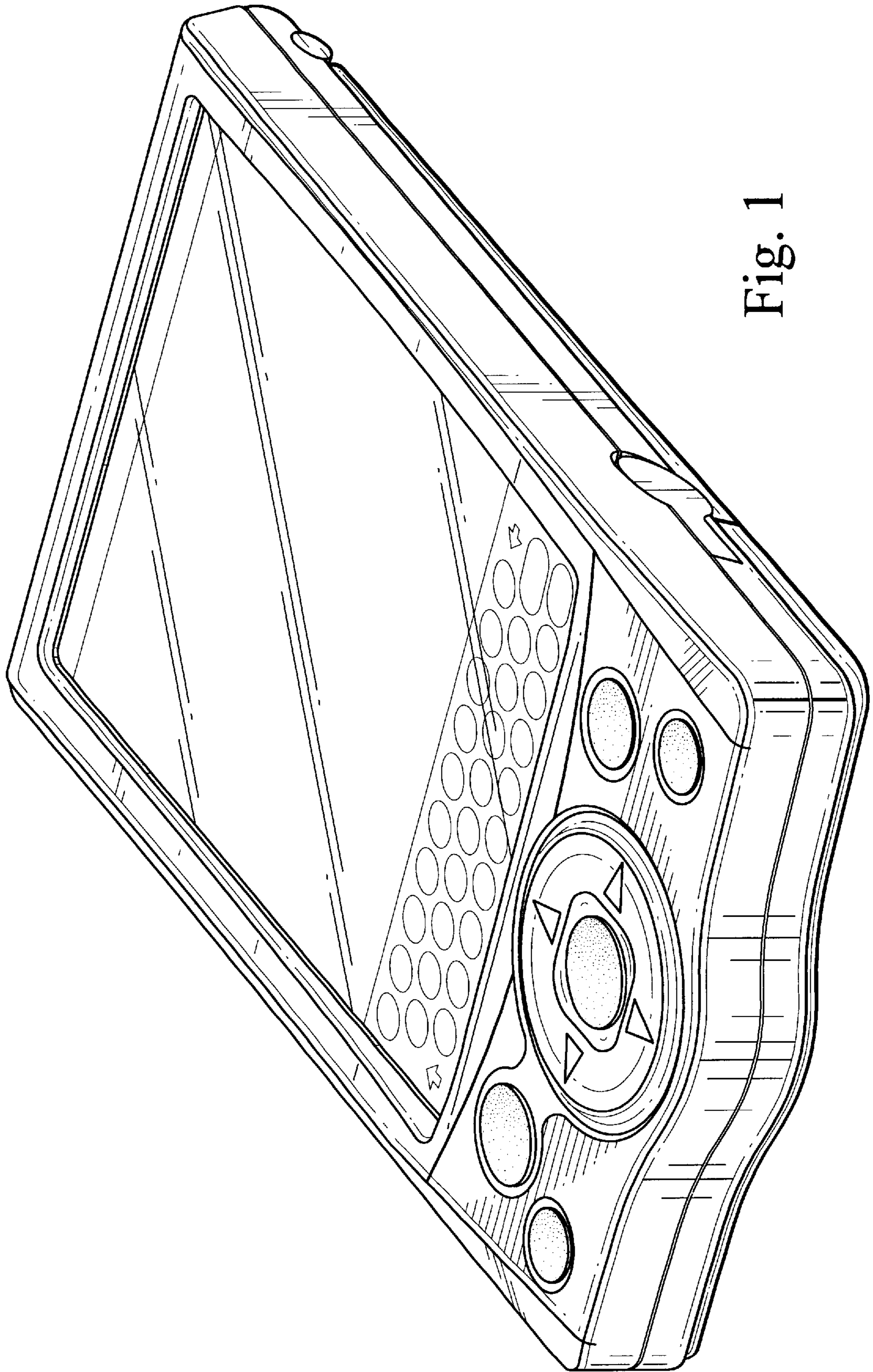

Fig. 1

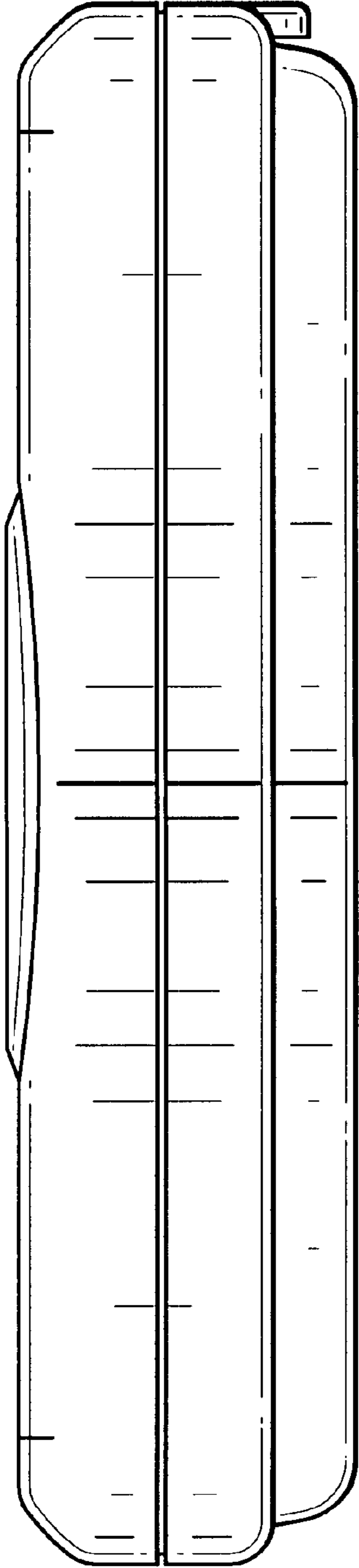

Fig. 2

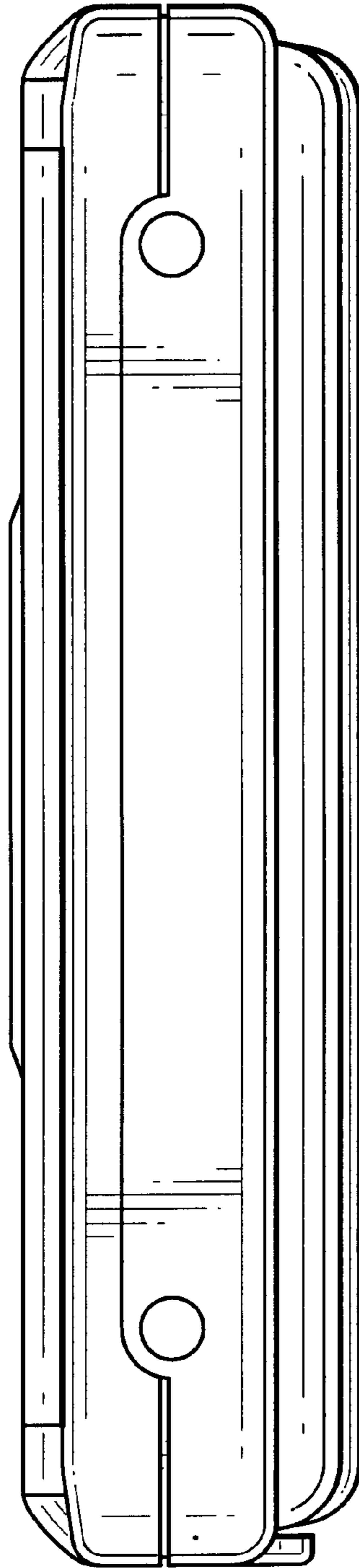

Fig. 3

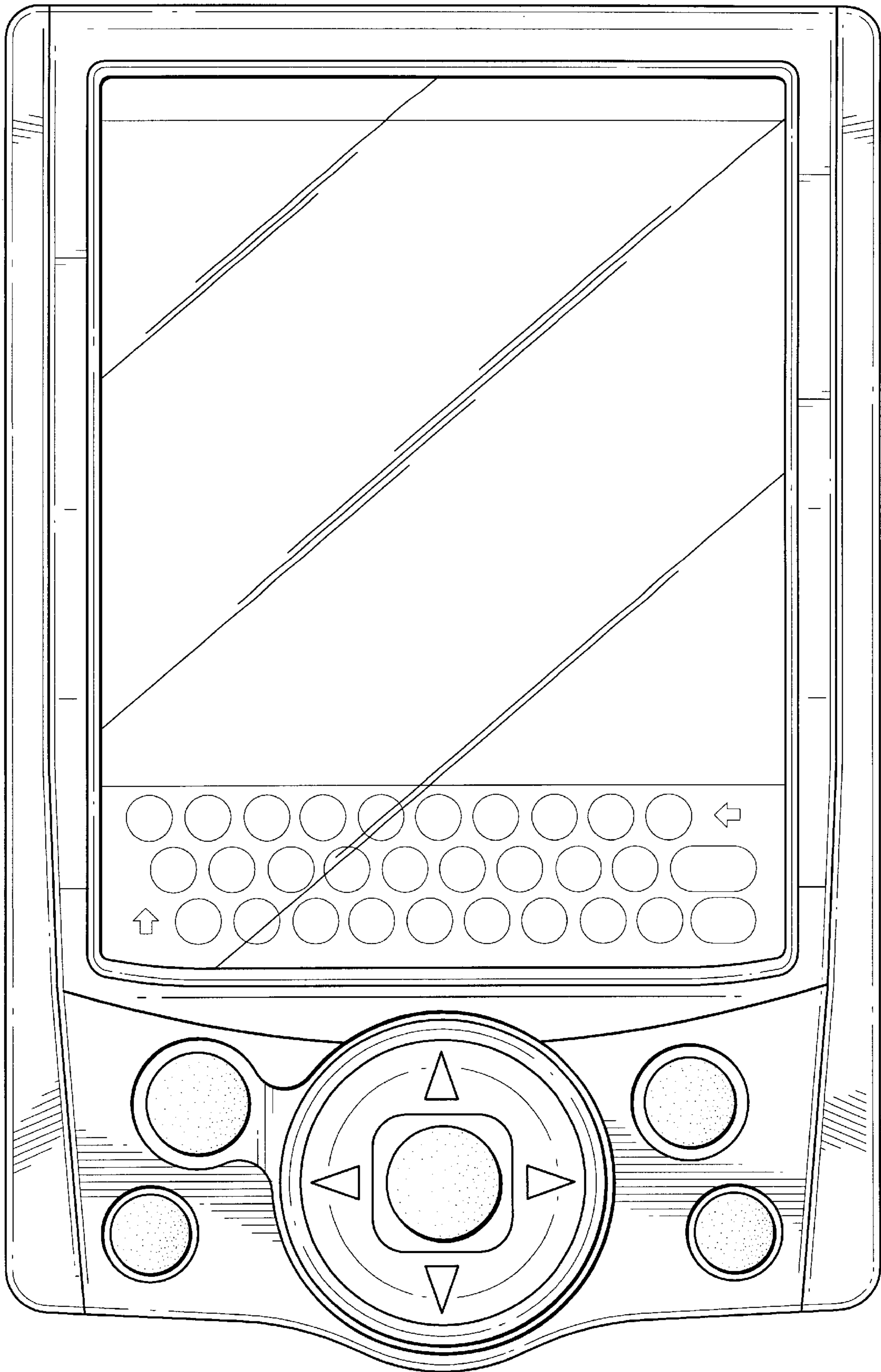

Fig. 4

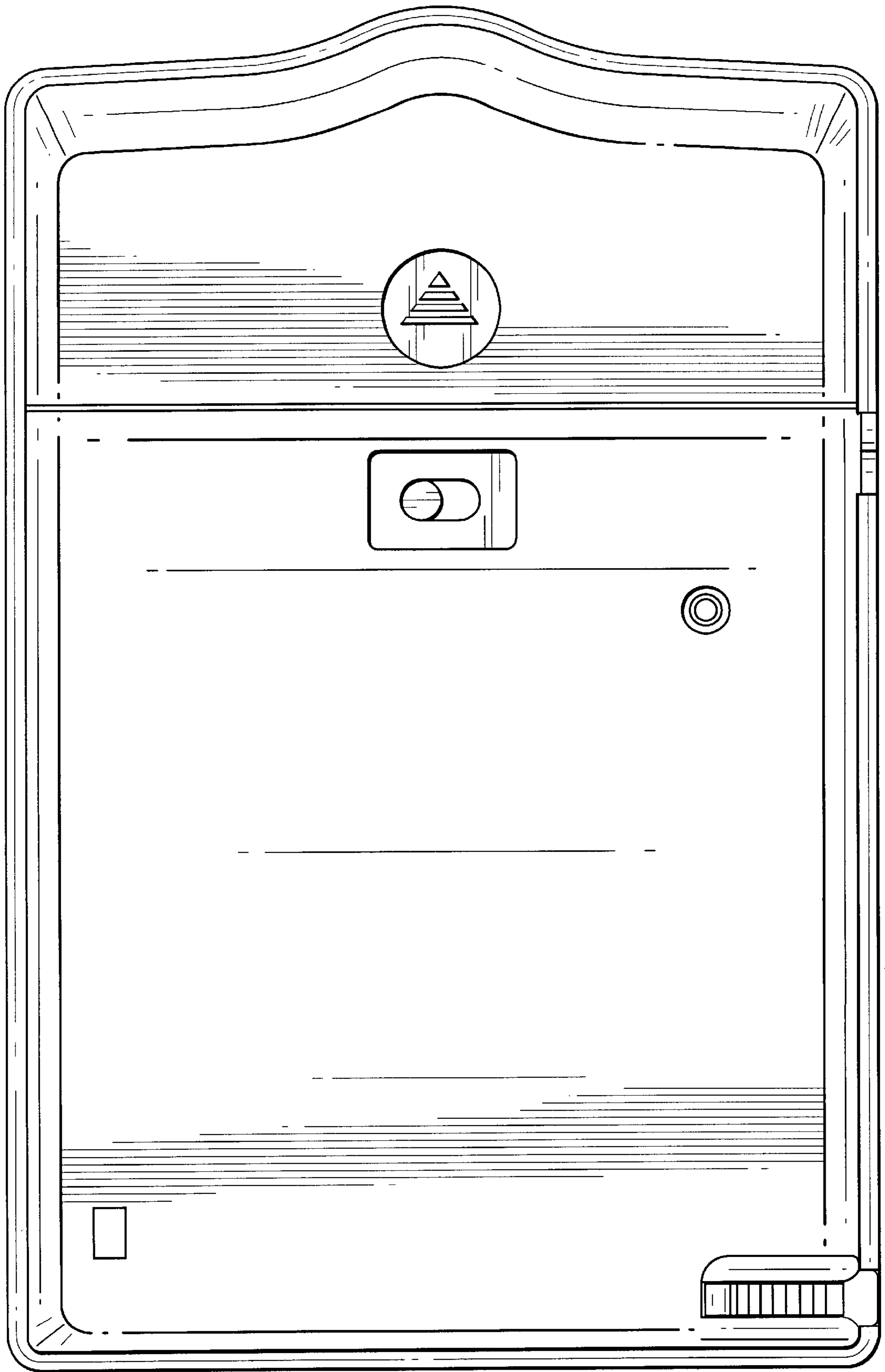

Fig. 5

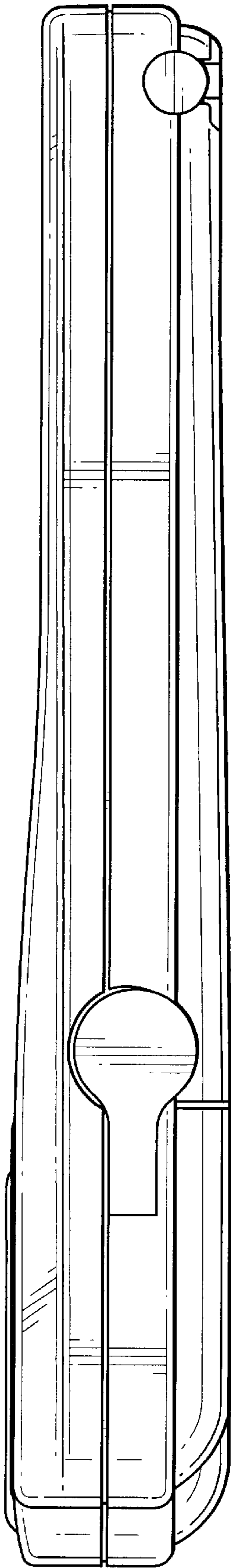

Fig. 6

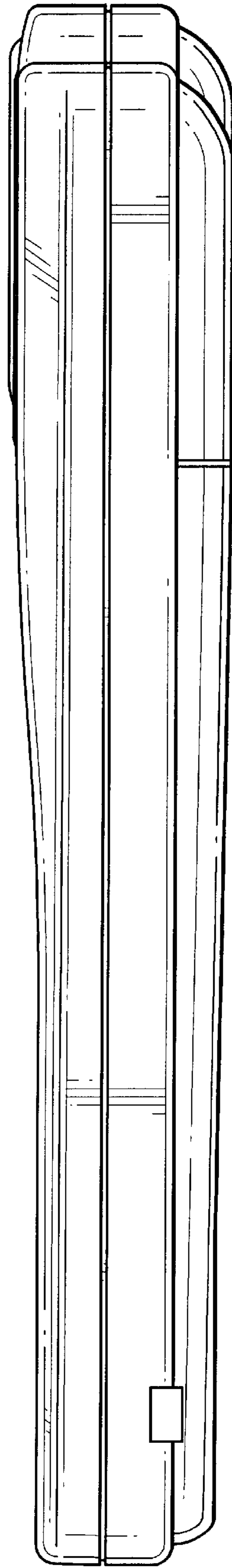

Fig. 7