

US00D464922S

(12) **United States Design Patent**
Kuo

(10) **Patent No.:** **US D464,922 S**

(45) **Date of Patent:** **** Oct. 29, 2002**

(54) **REARVIEW MIRROR**

D449,262 S * 10/2001 Kuo D12/187

(76) Inventor: **Fang-Mei Kuo**, No. 97, Chen Nan 6 St., Yung Kang, Tainan County (TW)

* cited by examiner

(**) Term: **14 Years**

Primary Examiner—Melody N. Brown
(74) *Attorney, Agent, or Firm*—Alan Kamrath; Rider, Bennett, Egan & Arundel, LLP

(21) Appl. No.: **29/148,608**

(57) **CLAIM**

(22) Filed: **Sep. 24, 2001**

The ornamental design for a rearview mirror, as shown and described.

(51) **LOC (7) Cl.** **12-16**

(52) **U.S. Cl.** **D12/187**

(58) **Field of Search** D12/187-189;
359/864-881, 842, 846, 855; 248/475.1,
480-487

DESCRIPTION

FIG. 1 is a perspective view of for a rearview mirror showing my design;
FIG. 2 is a front elevational view thereof;
FIG. 3 is rear elevational view thereof;
FIG. 4 is a left side elevational view thereof;
FIG. 5 is a right side elevational view thereof;
FIG. 6 is a top plan view thereof; and
FIG. 7 is a bottom plan view thereof; and,
FIG. 8 is a perspective exploded view of a rearview mirror showing my new design.

(56) **References Cited**

U.S. PATENT DOCUMENTS

5,313,336	A	*	5/1994	Sakao et al.	359/841
5,841,594	A	*	11/1998	Rothe	359/841
6,036,325	A	*	3/2000	Su	359/871
D427,127	S	*	6/2000	Horowitz	D12/187
D428,840	S	*	8/2000	Weidhase	D12/187
D440,921	S	*	4/2001	Schmidt et al.	D12/187

1 Claim, 5 Drawing Sheets

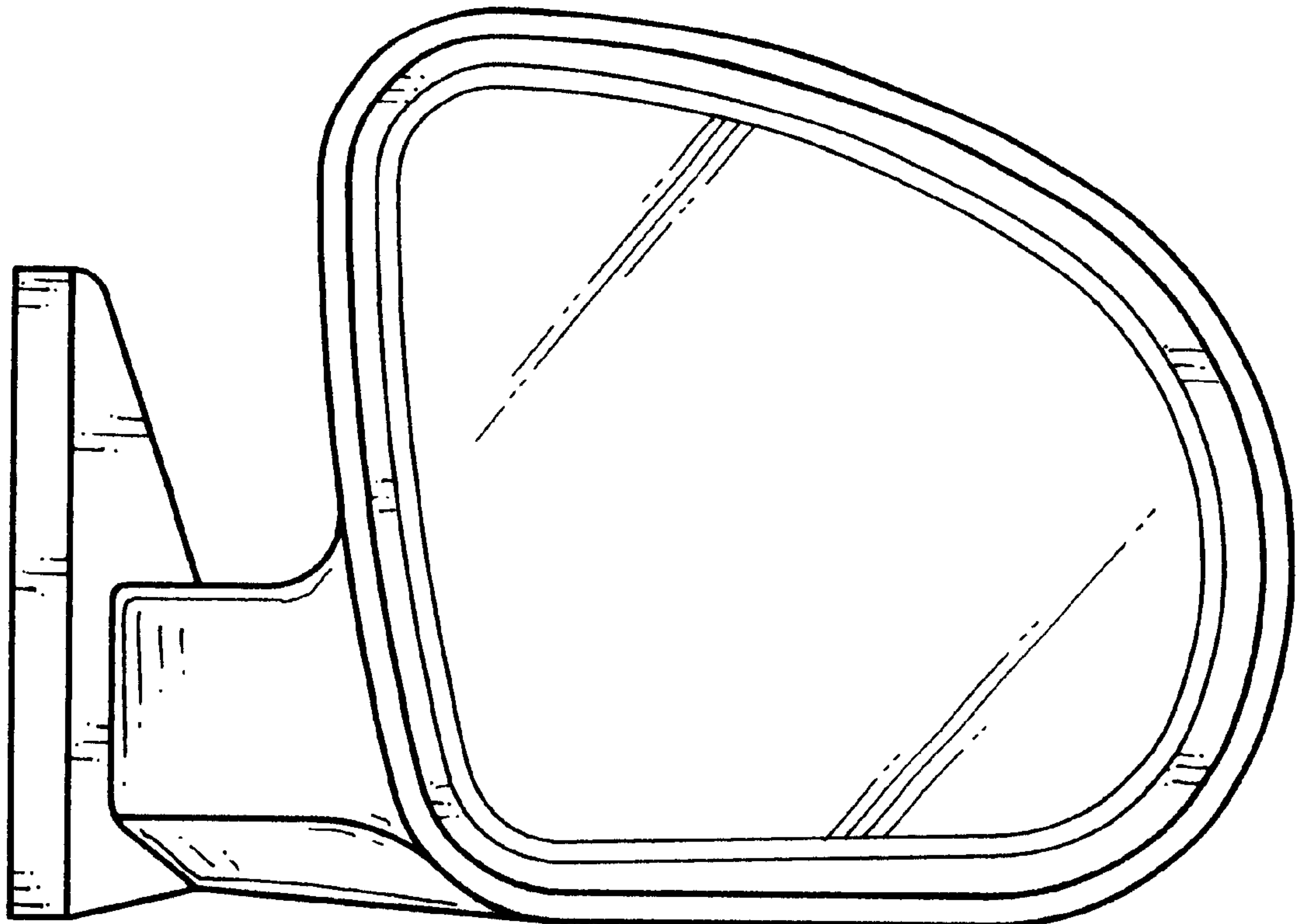

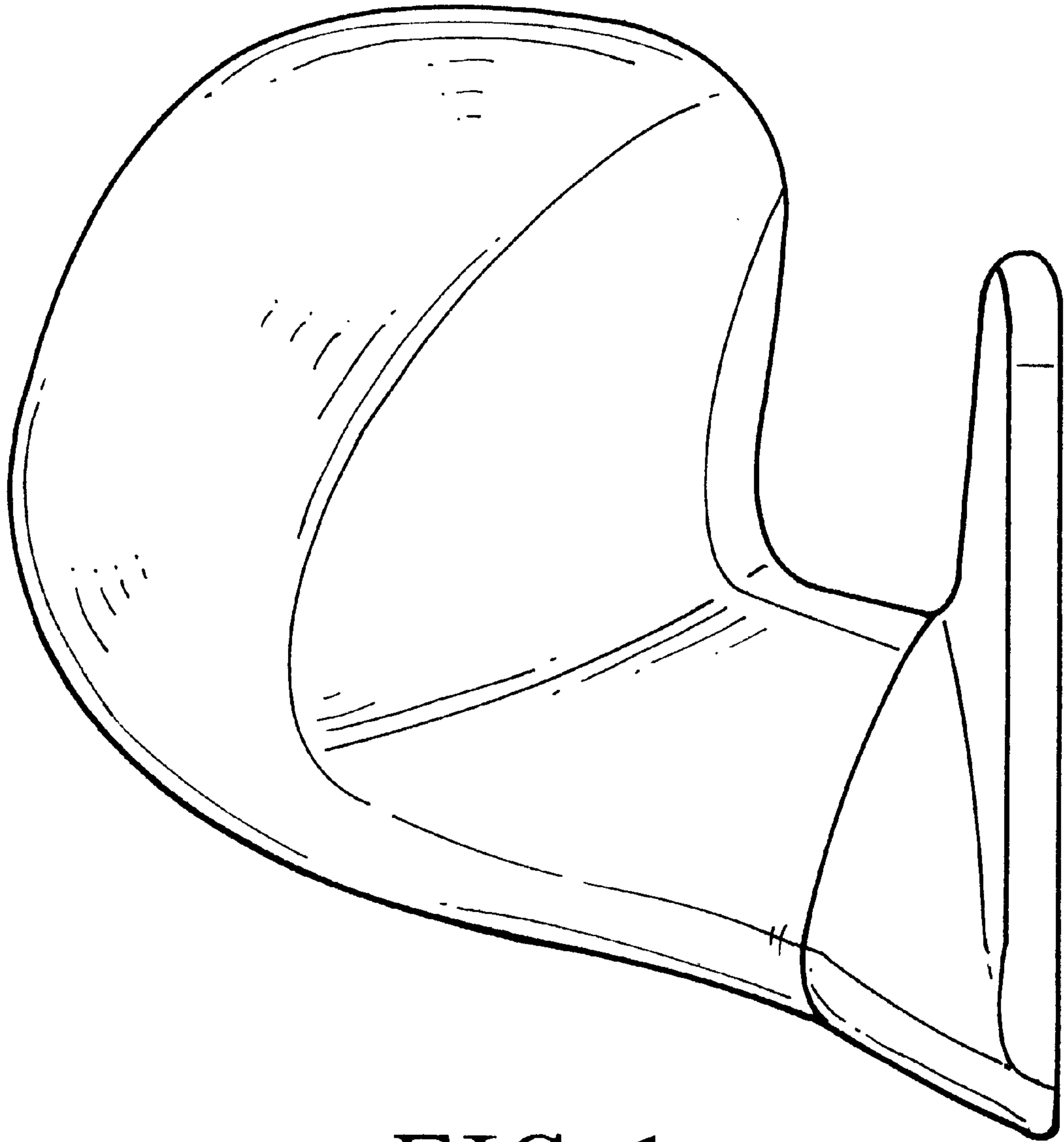

FIG. 1

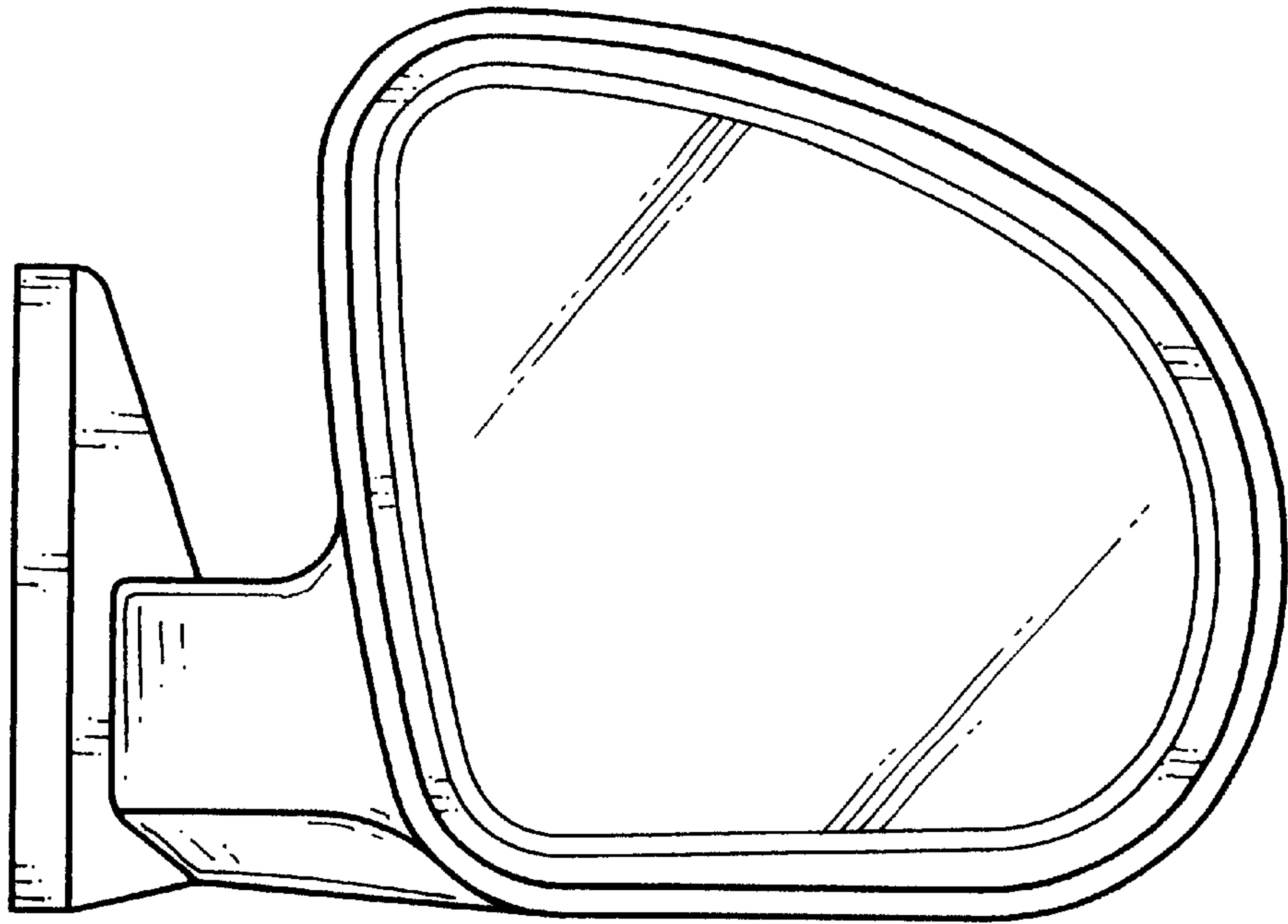

FIG. 2

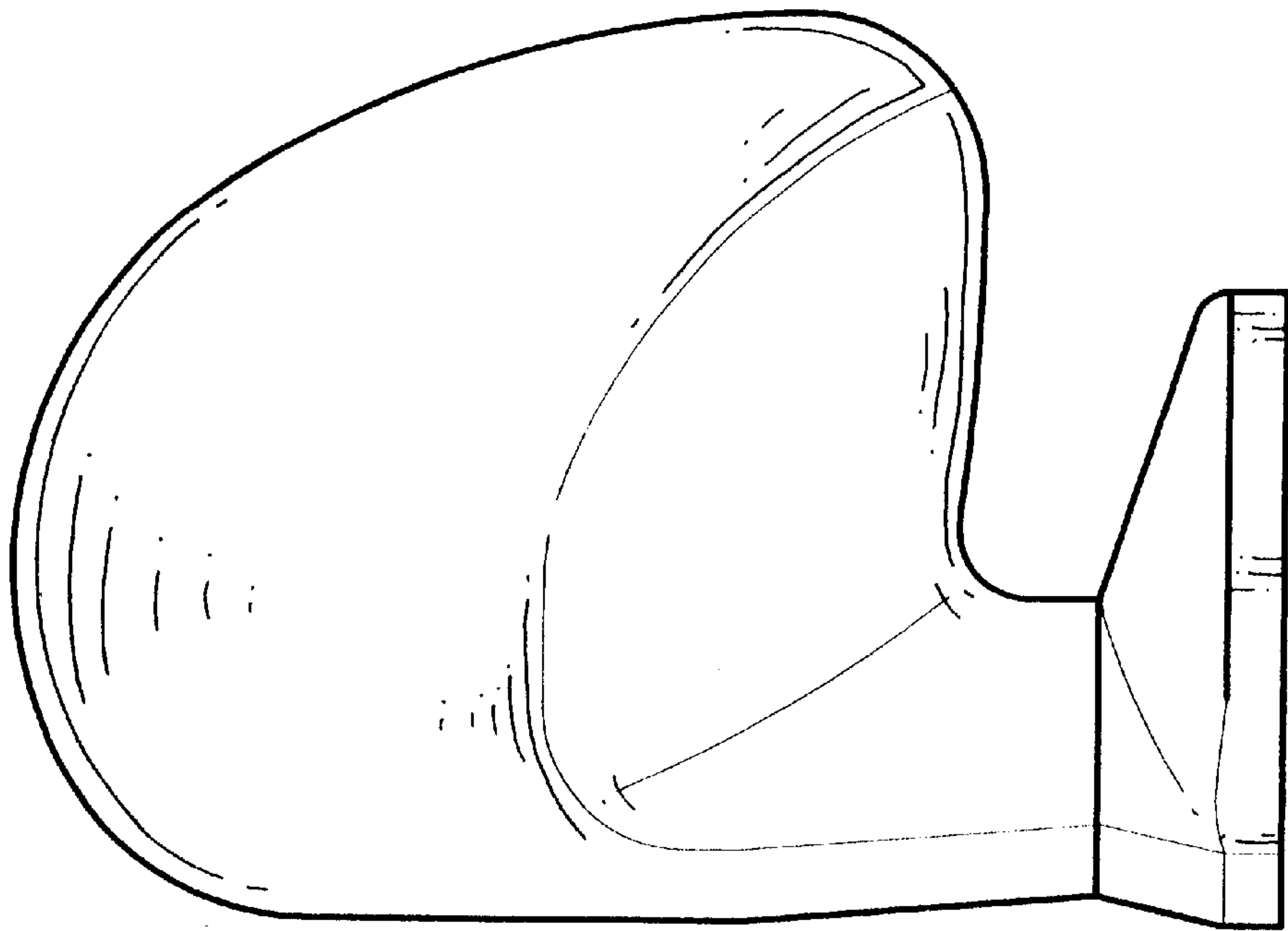

FIG. 3

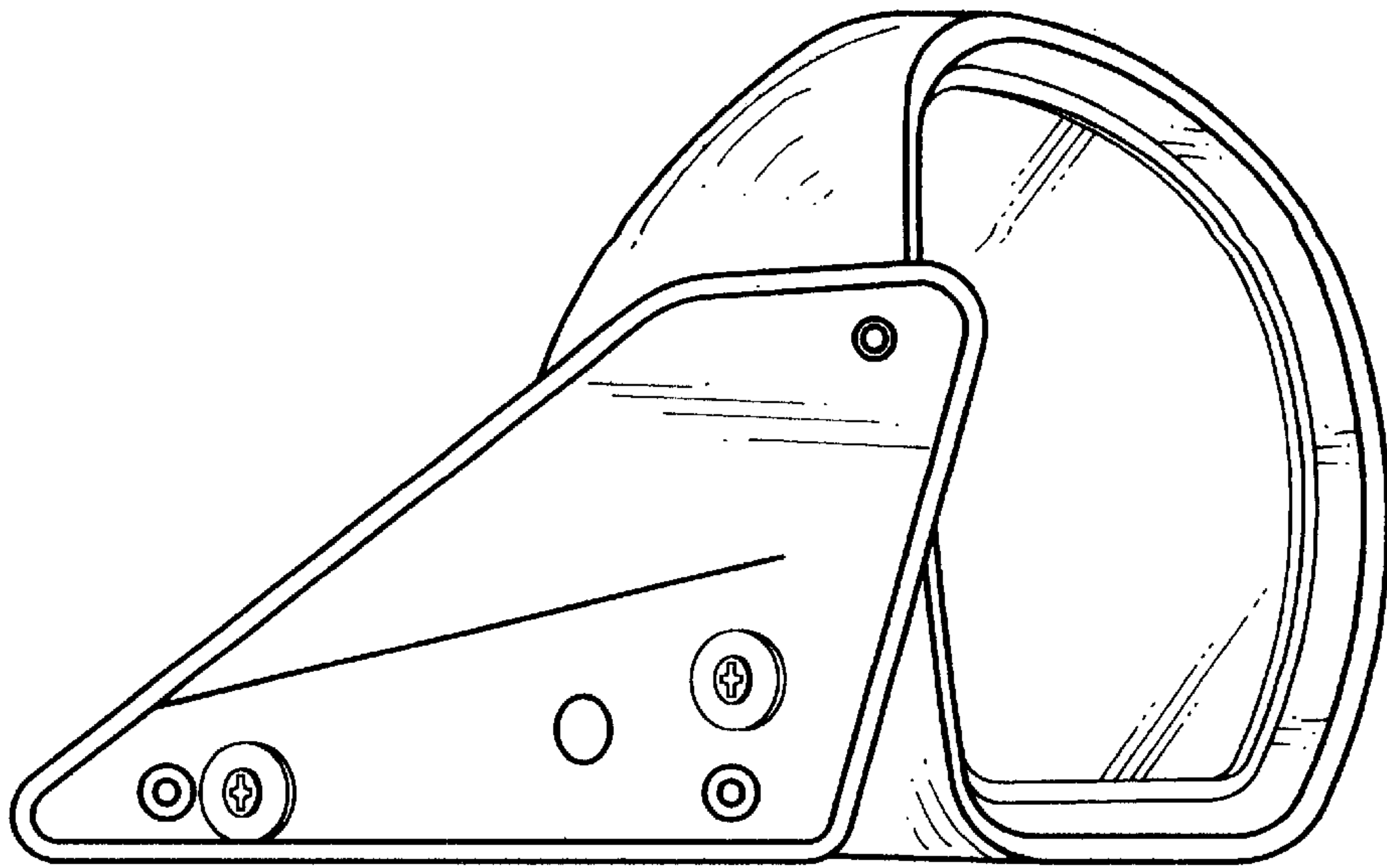

FIG. 4

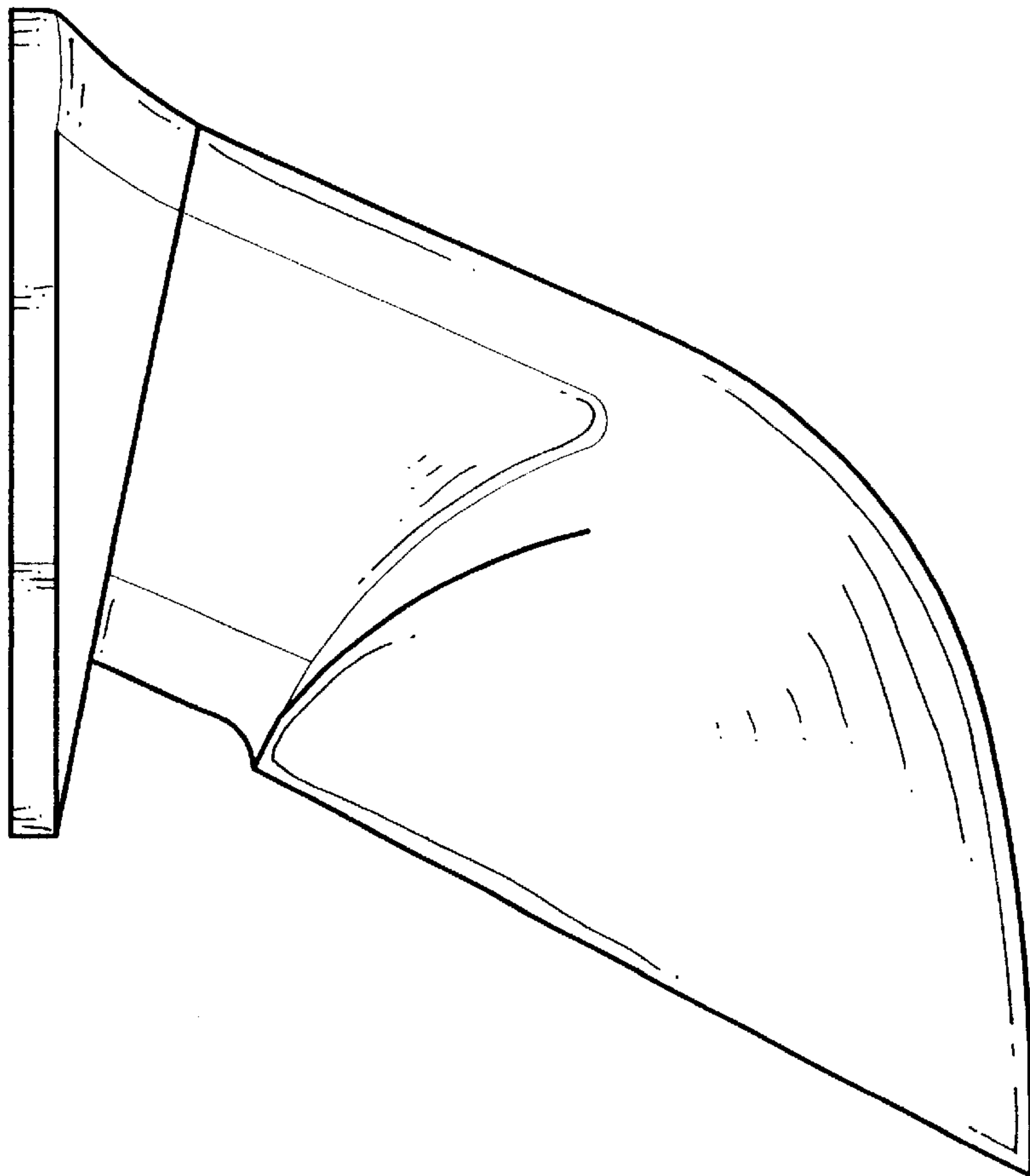

FIG. 6

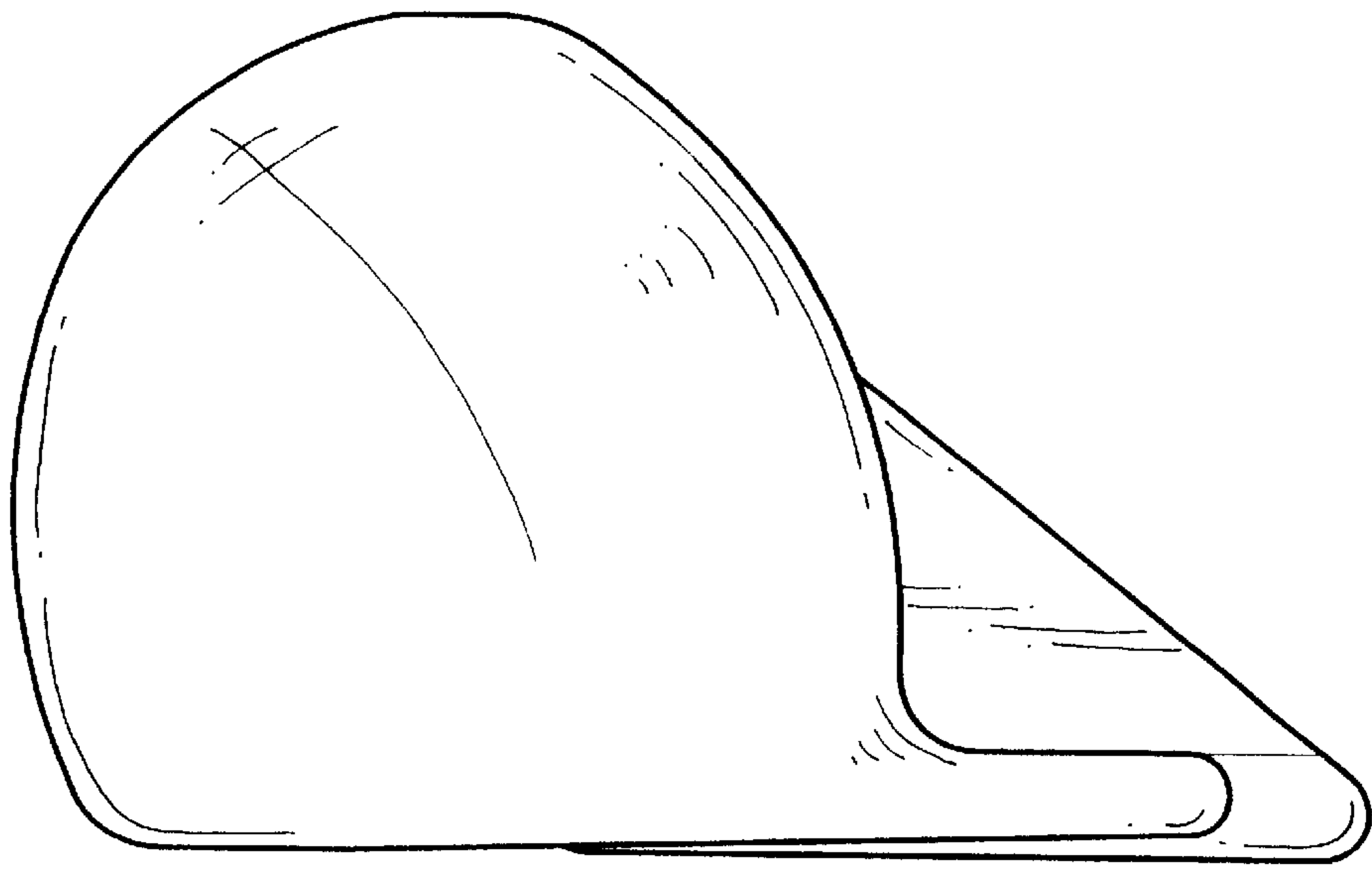

FIG. 5

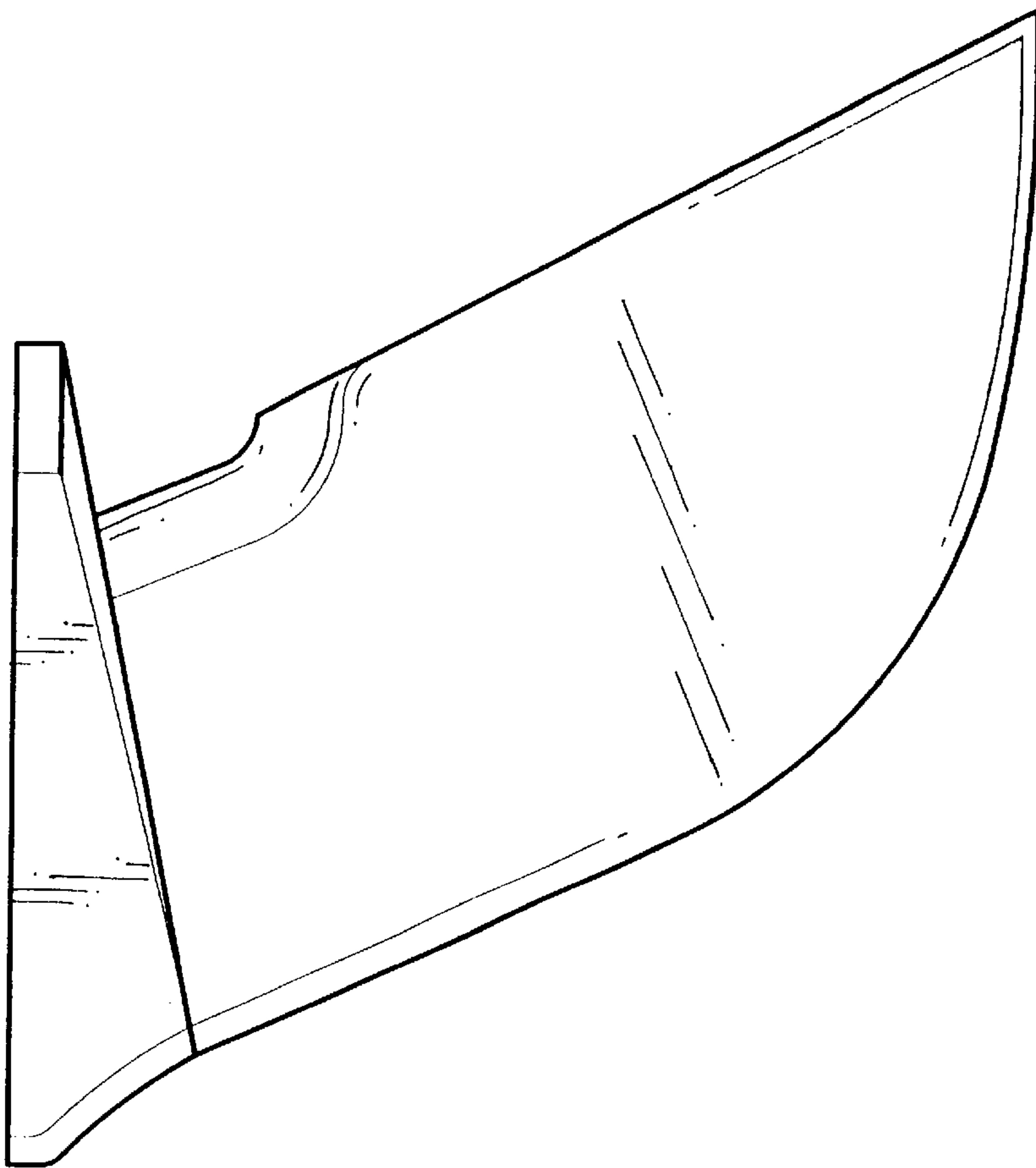

FIG. 7

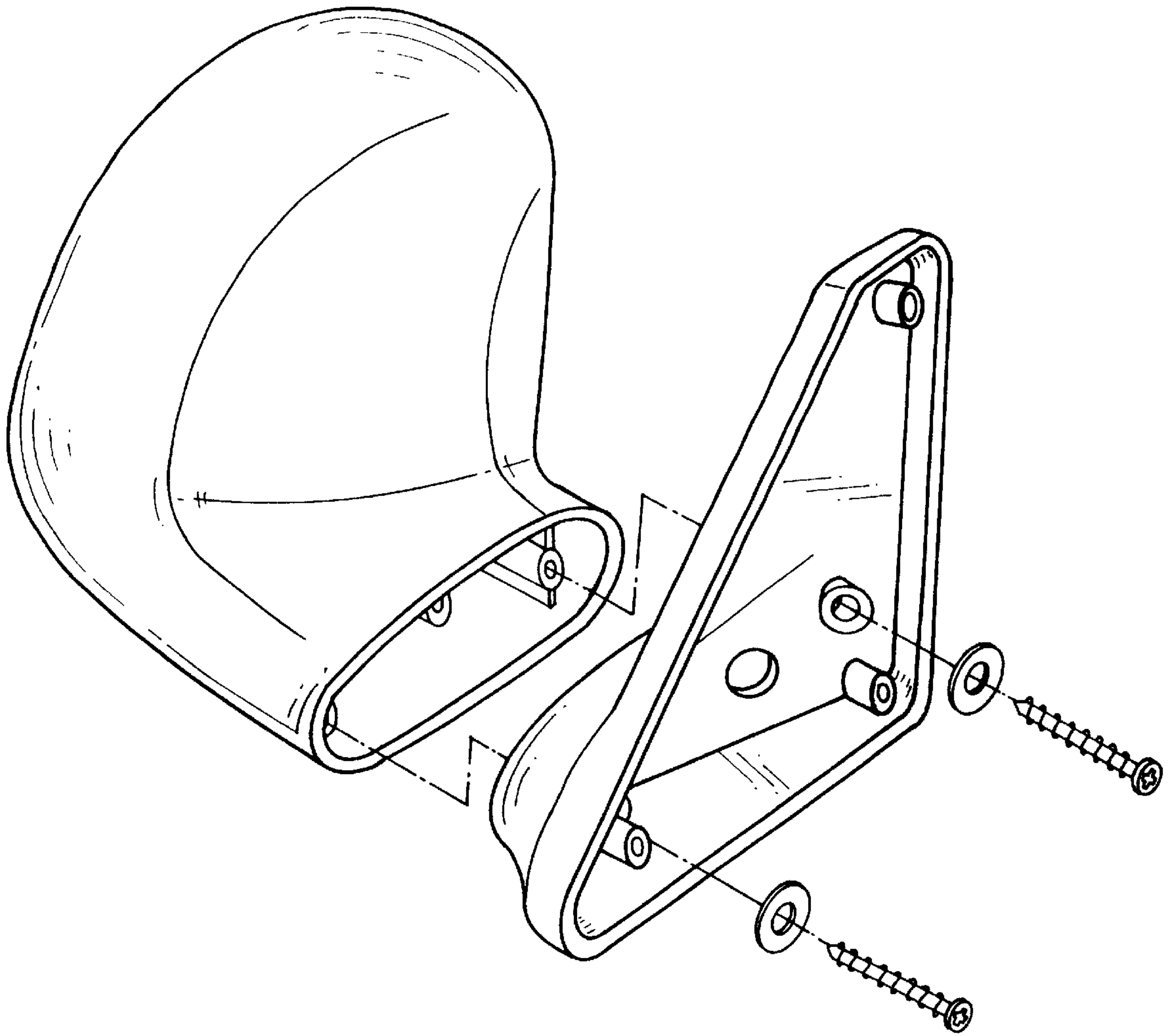

FIG. 8