



US00D464915S

(12) **United States Design Patent**
Okonkwo

(10) **Patent No.:** **US D464,915 S**

(45) **Date of Patent:** **** Oct. 29, 2002**

(54) **MODERN SPORTS COUPE CAR BODY**

(57) **CLAIM**

(75) Inventor: **Chidi Okonkwo**, 670 McGill, Atlanta, GA (US) 30312

The ornamental design for a modern sports coupe car body, as shown and described.

(73) Assignee: **Chidi Okonkwo**, Atlanta, GA (US)

DESCRIPTION

(**) Term: **14 Years**

FIG. 1 is a front perspective view of the modern sports coupe car body, showing the new design.

(21) Appl. No.: **29/153,872**

FIG. 2 is a rear perspective view of the modern sports coupe car body shown in FIG. 1.

(22) Filed: **Jan. 15, 2002**

FIG. 3 is a side view of the modern sports coupe car body shown in FIG. 1.

(51) **LOC (7) Cl.** **12-08**

FIG. 4 is a top plan view of the modern sports coupe car body shown in FIG. 1.

(52) **U.S. Cl.** **D12/92; D12/88**

FIG. 5 is a rear perspective view of the modern sports coupe car body shown in FIG. 1, with the left door opened, and the trunk opened (alternate positions).

(58) **Field of Search** **D12/90-92, 86-88; 296/185**

(56) **References Cited**

FIG. 6 is a front view of the modern sports coupe car body shown in FIG. 1; and,

U.S. PATENT DOCUMENTS

FIG. 7 is a rear view of the modern sports coupe car body shown in FIG. 1.

D411,138 S * 6/1999 Ramaciotti D12/92

It will be understood that the broken lines showing tires and wheels through out the drawings are for illustrative purposes only and does not form any part of the subject design.

D451,844 S * 12/2001 Thomas D12/92

D455,102 S * 4/2002 Cryns D12/92

* cited by examiner

Primary Examiner—Melody N. Brown

1 Claim, 5 Drawing Sheets

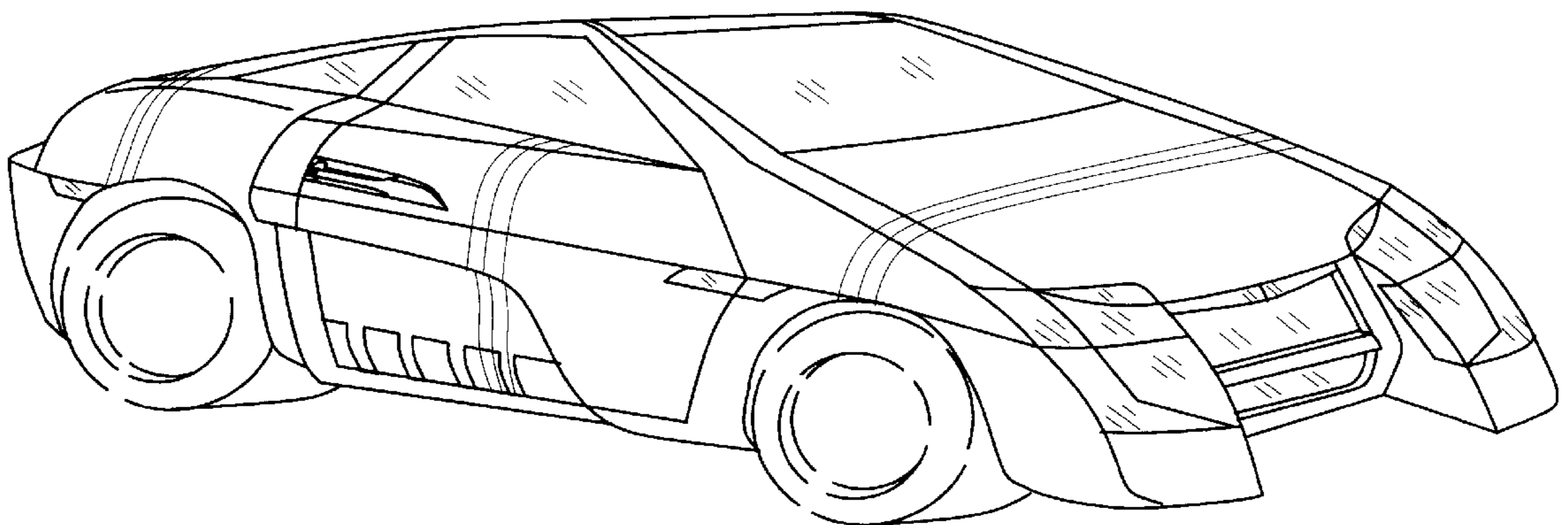

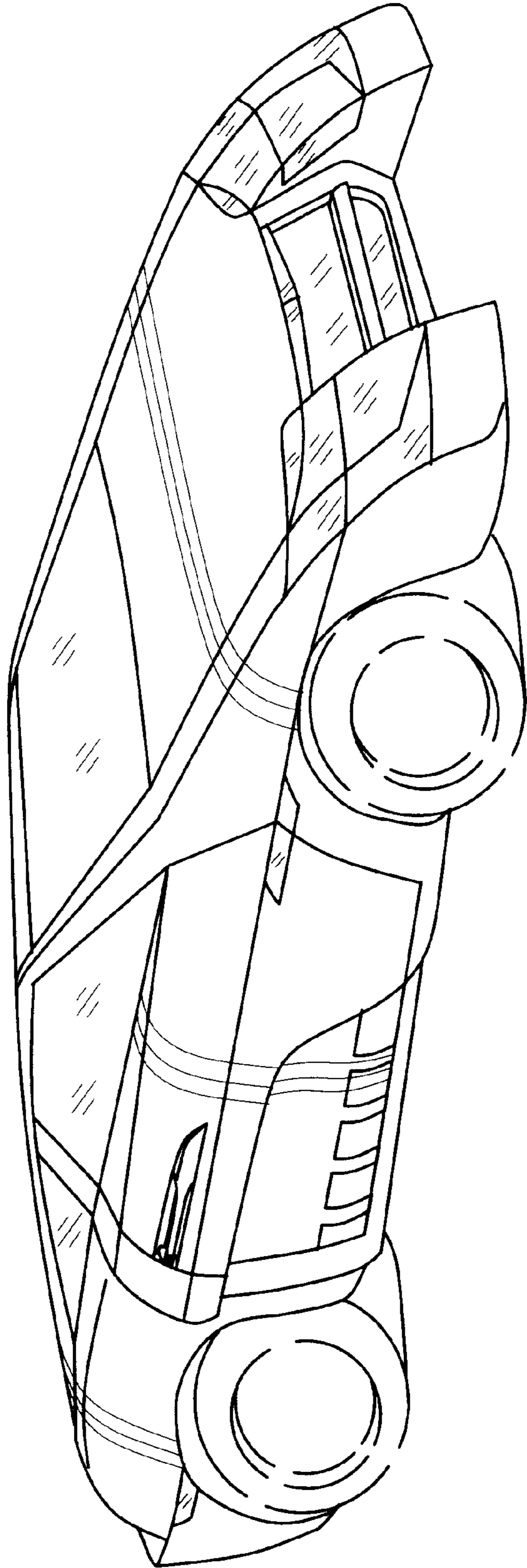

Fig - 1

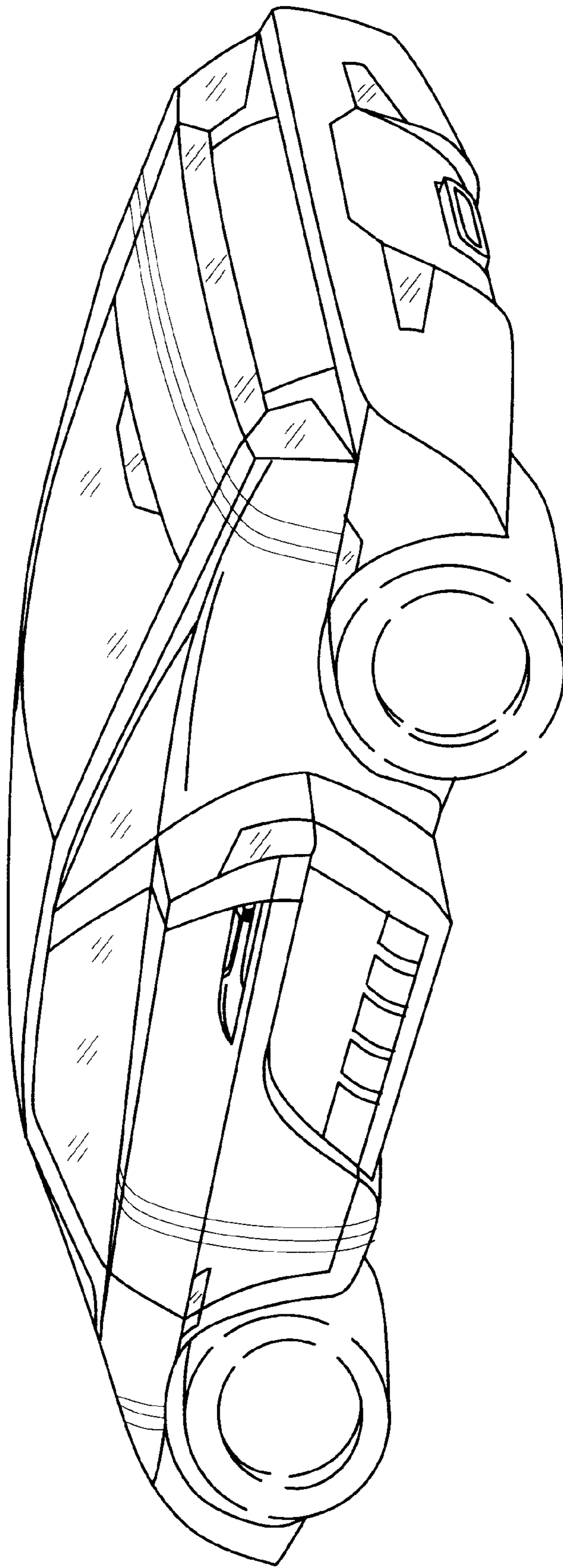

Fig - 2

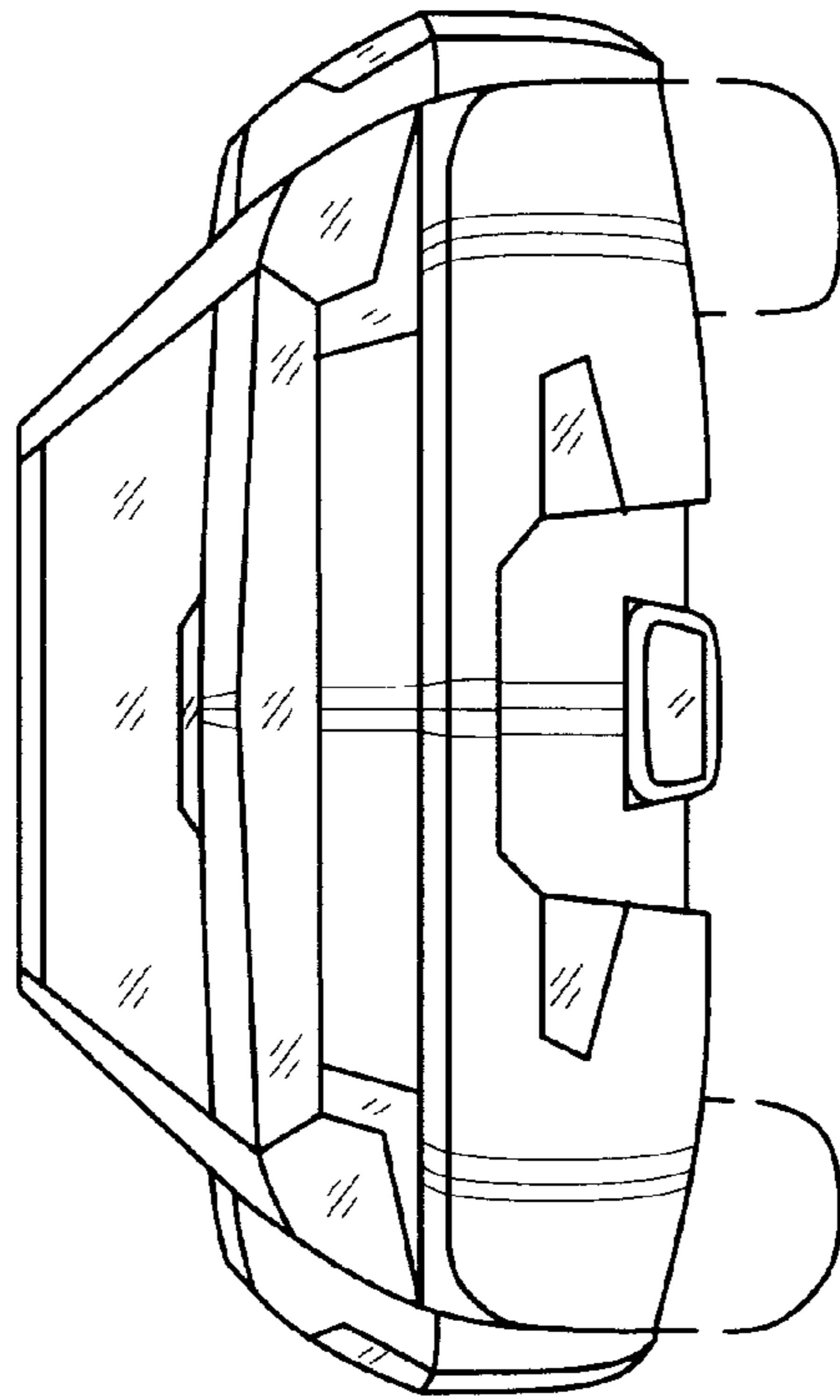

Fig - 4

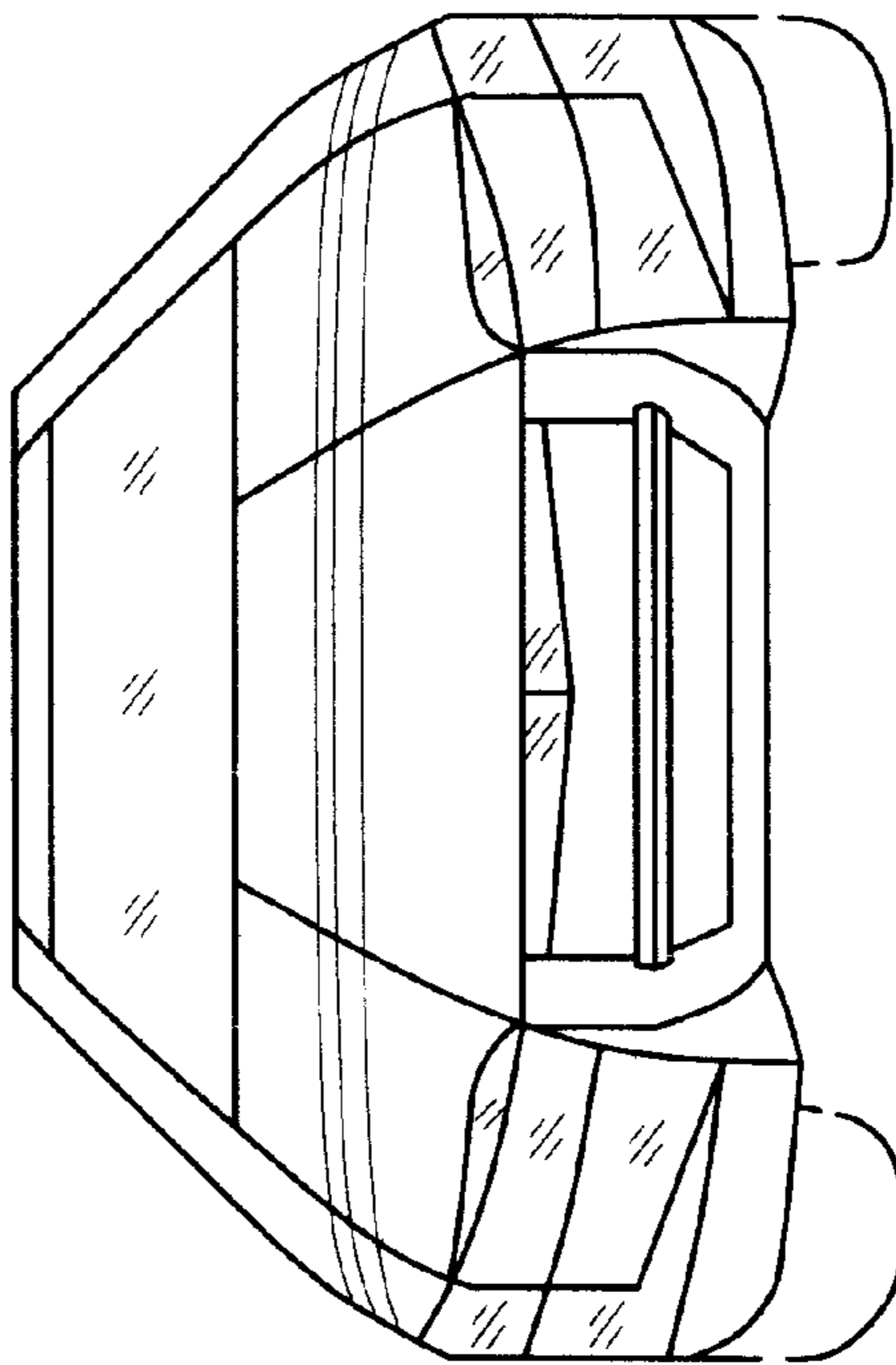

Fig - 3

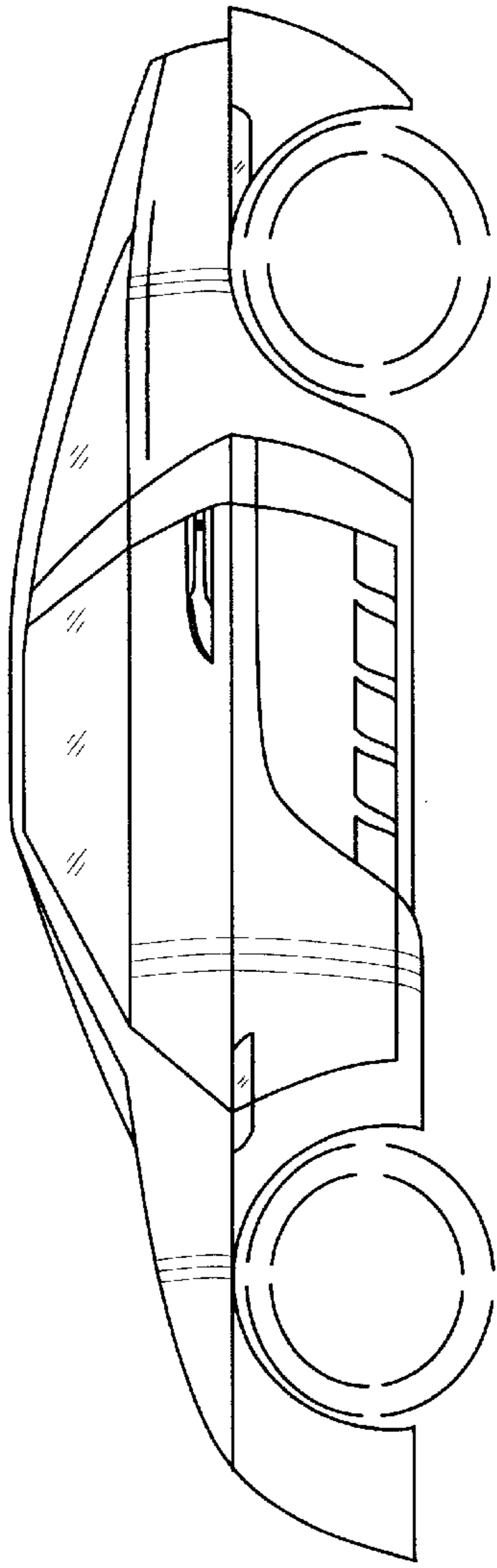

Fig - 5

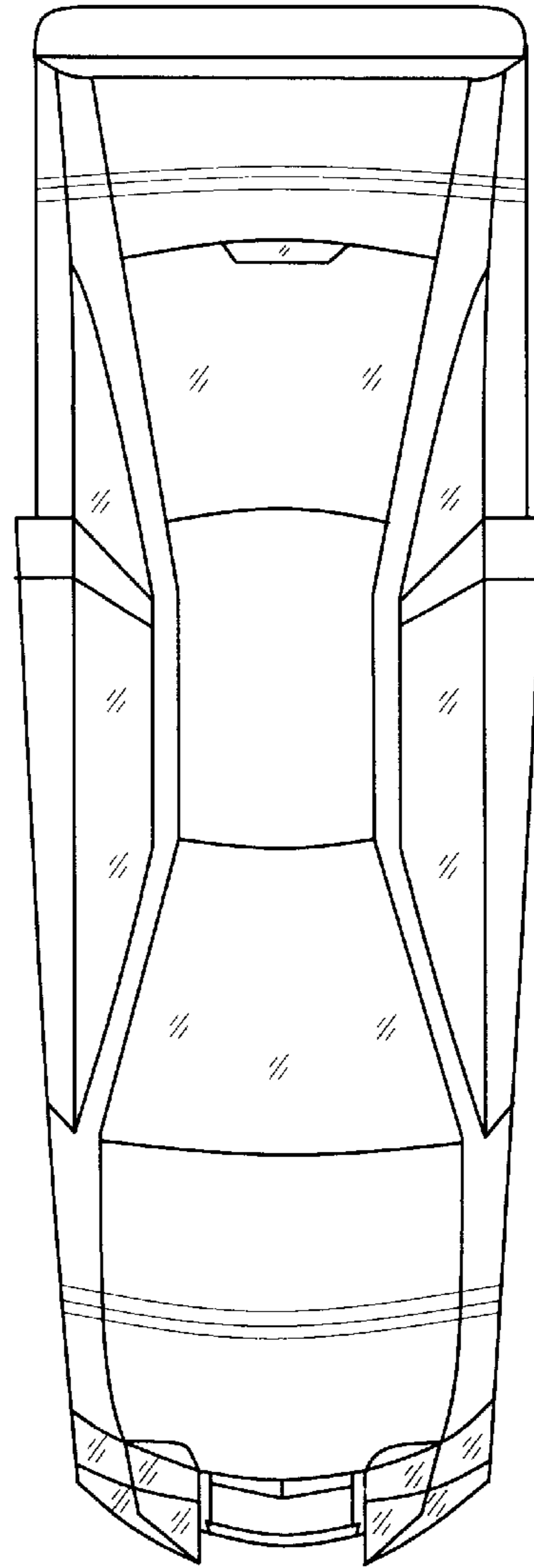

Fig - 6

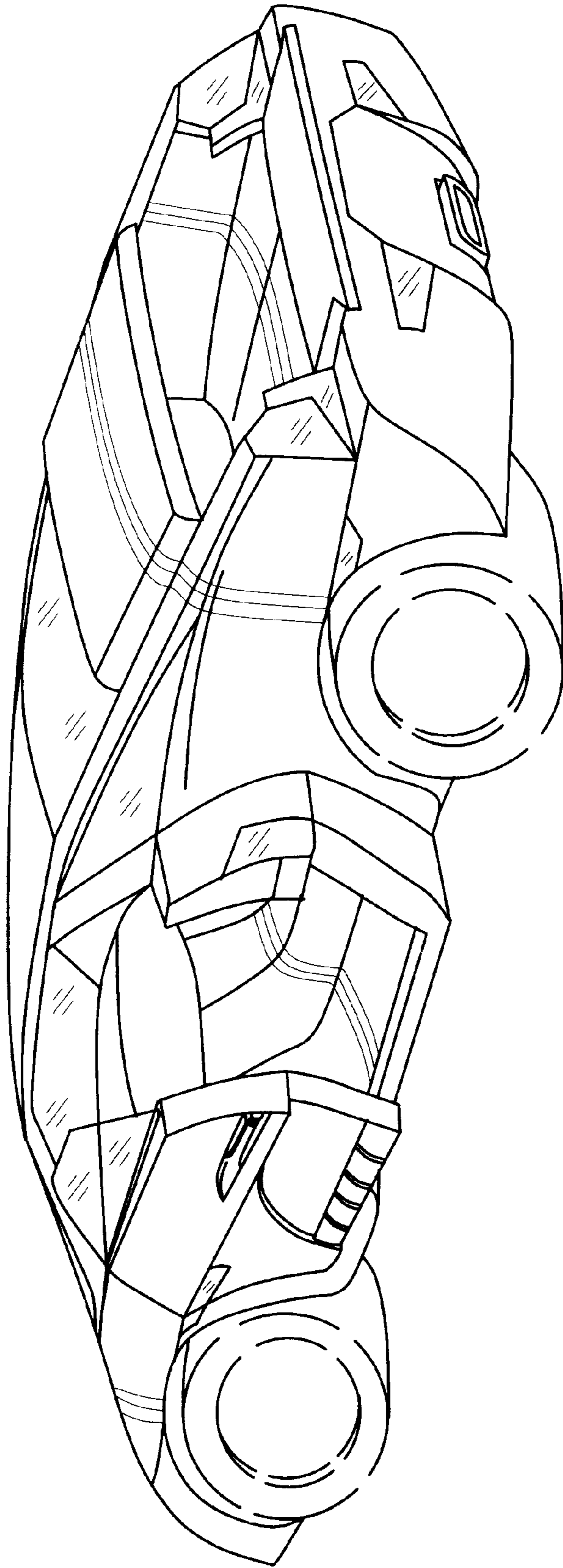

Fig - 7