



US00D464834S

(12) **United States Design Patent**
Yen

(10) **Patent No.:** **US D464,834 S**

(45) **Date of Patent:** **** Oct. 29, 2002**

(54) **TOWEL HOLDER**

(76) Inventor: **Kuo-Chi Yen**, No. 310, Wenshinnan 6th
Rd., Nantuen Chiu, Taichung (TW)

(**) Term: **14 Years**

(21) Appl. No.: **29/150,865**

(22) Filed: **Nov. 29, 2001**

(51) **LOC (7) Cl.** **06-04**

(52) **U.S. Cl.** **D6/546**

(58) **Field of Search** D6/546-50, 518,
D6/522-24; D8/300, 307-308, 315-20;
108/29; 211/13.1, 16, 60.1, 86.01, 87.01,
88.04, 105.1-105.2, 106, 123, 181.1; 242/570,
588-90, 597-98; 248/49, 175, 200-201,
205.1, 214, 251-54, 261, 302, 304, 309.1,
314-17

(56) **References Cited**

U.S. PATENT DOCUMENTS

D318,590 S	7/1991	McKeone	D6/524
D328,215 S	7/1992	McKeone	D6/524
D337,014 S	7/1993	Wang	D6/550
D337,230 S	7/1993	Wang	D6/550
D357,379 S	4/1995	Lehn et al.	D6/549
D357,840 S	5/1995	Lehn et al.	D6/549
D362,361 S	9/1995	Lehn et al.	D6/523
D385,735 S	* 11/1997	Hundley et al.	D6/524
D390,397 S	2/1998	Chen	D6/550
D398,176 S	* 9/1998	Moore et al.	D6/550
D406,484 S	3/1999	Wu	D6/566
D407,931 S	4/1999	Sweetman	D6/524

D408,188 S	*	4/1999	Kuo	D6/550
D408,669 S		4/1999	Kuo	D6/550
D416,785 S		11/1999	Ming-Hsiao	D8/363
D417,112 S		11/1999	Chen	D6/546
D417,576 S		12/1999	Ming-Hsiao	D6/549
D417,989 S		12/1999	Moore et al.	D6/524
D417,995 S		12/1999	Chen	D6/550
D424,354 S		5/2000	Duggan	D6/550
D425,348 S	*	5/2000	Chen	D6/524
D434,934 S	*	12/2000	Solowiej	D6/546
D436,776 S	*	1/2001	Chen	D6/524
D453,274 S	*	2/2002	Lai	D6/524
D453,434 S	*	2/2002	Ou-Young	D6/546
D454,744 S	*	3/2002	Ou-Young	D6/550

* cited by examiner

Primary Examiner—Brian N. Vinson
(74) *Attorney, Agent, or Firm*—Brinks Hofer Gilson & Lione

(57) **CLAIM**

The ornamental design for a towel holder, as shown and described.

DESCRIPTION

FIG. 1 is a perspective view showing my new design.
FIG. 2 is a top elevational view thereof.
FIG. 3 is a bottom elevational view thereof.
FIG. 4 is a left elevational view thereof.
FIG. 5 is a right elevational view thereof.
FIG. 6 is a front elevational view thereof; and,
FIG. 7 is a rear elevational view thereof.

1 Claim, 4 Drawing Sheets

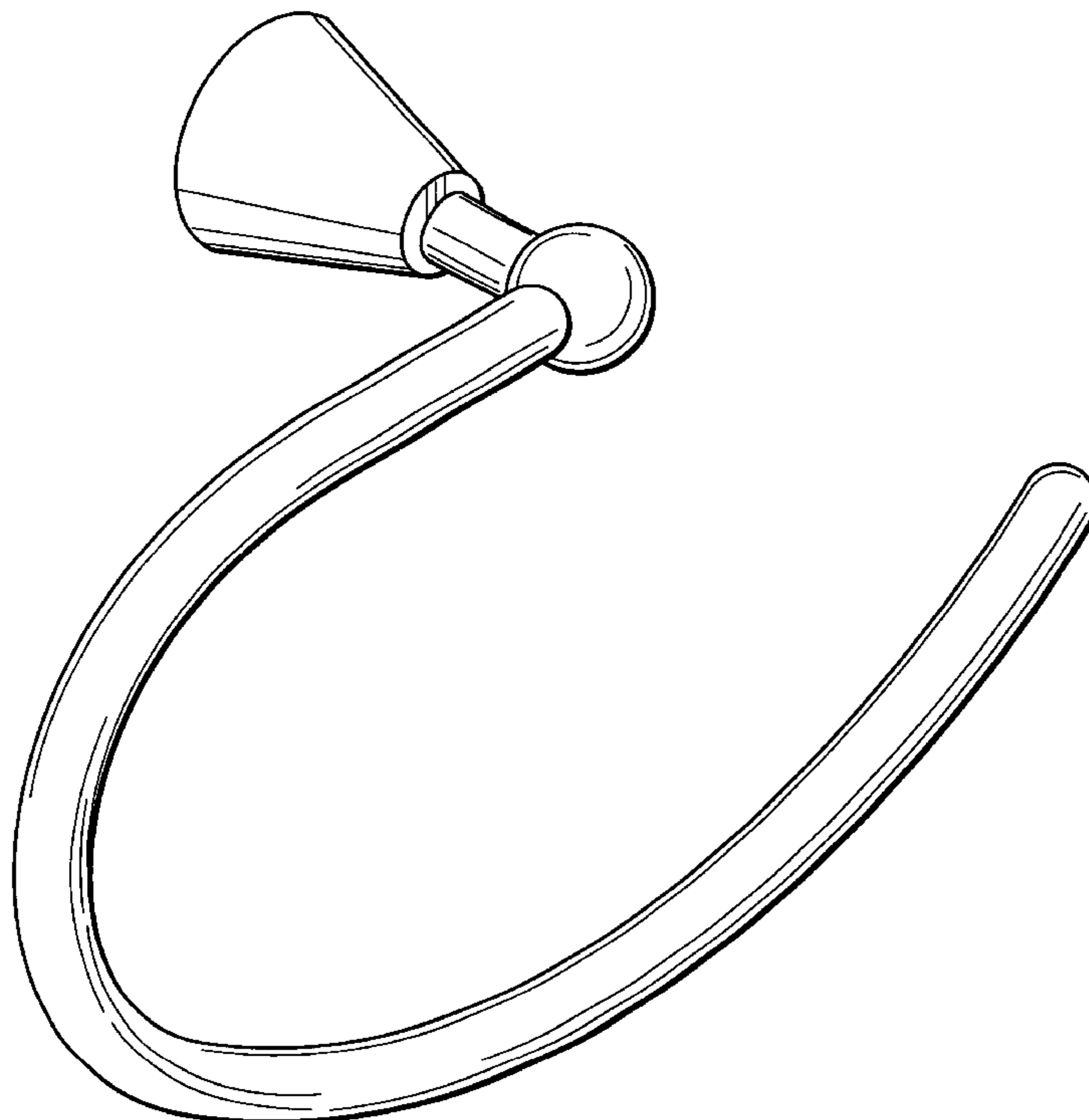

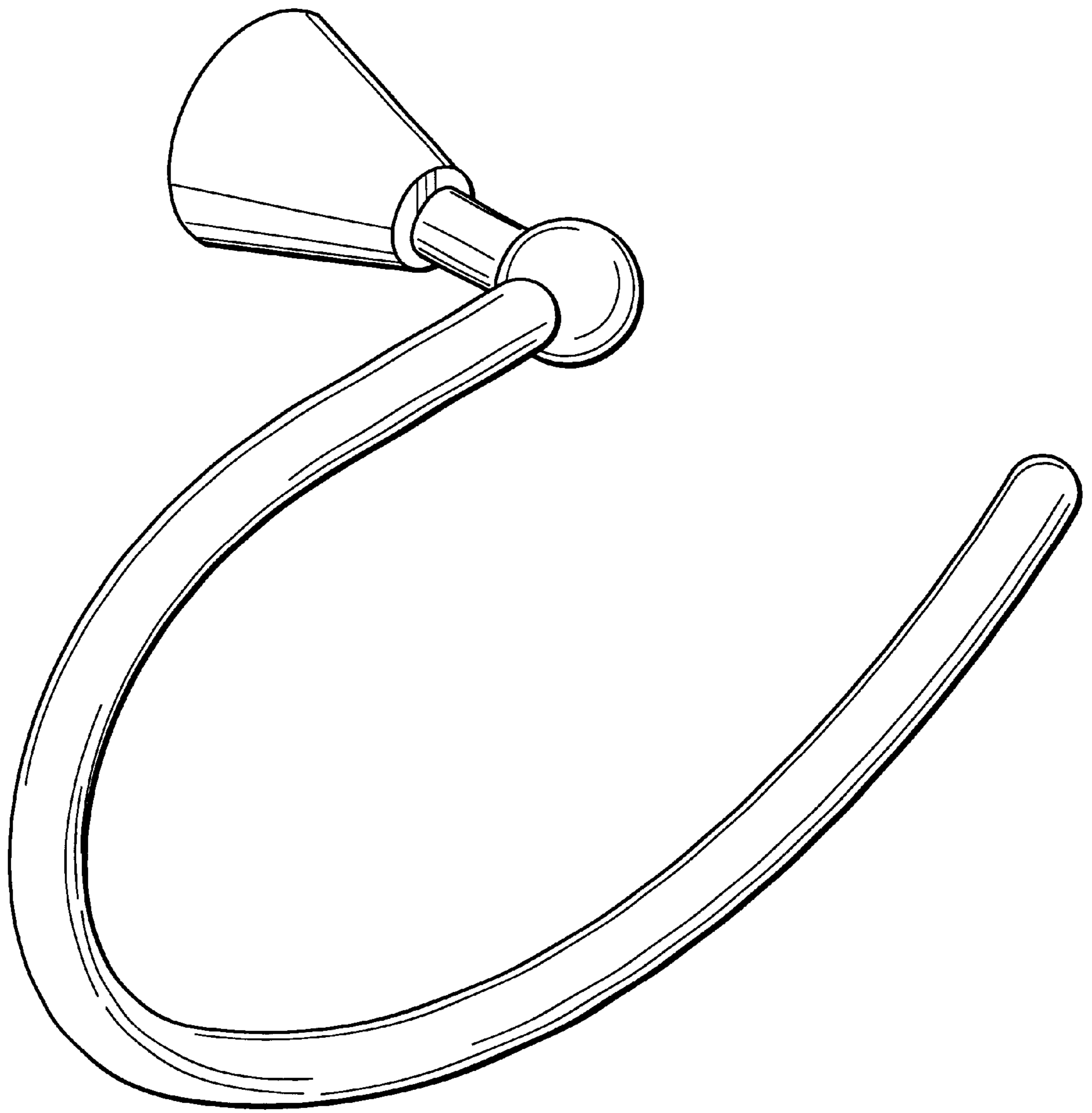

FIG. 1

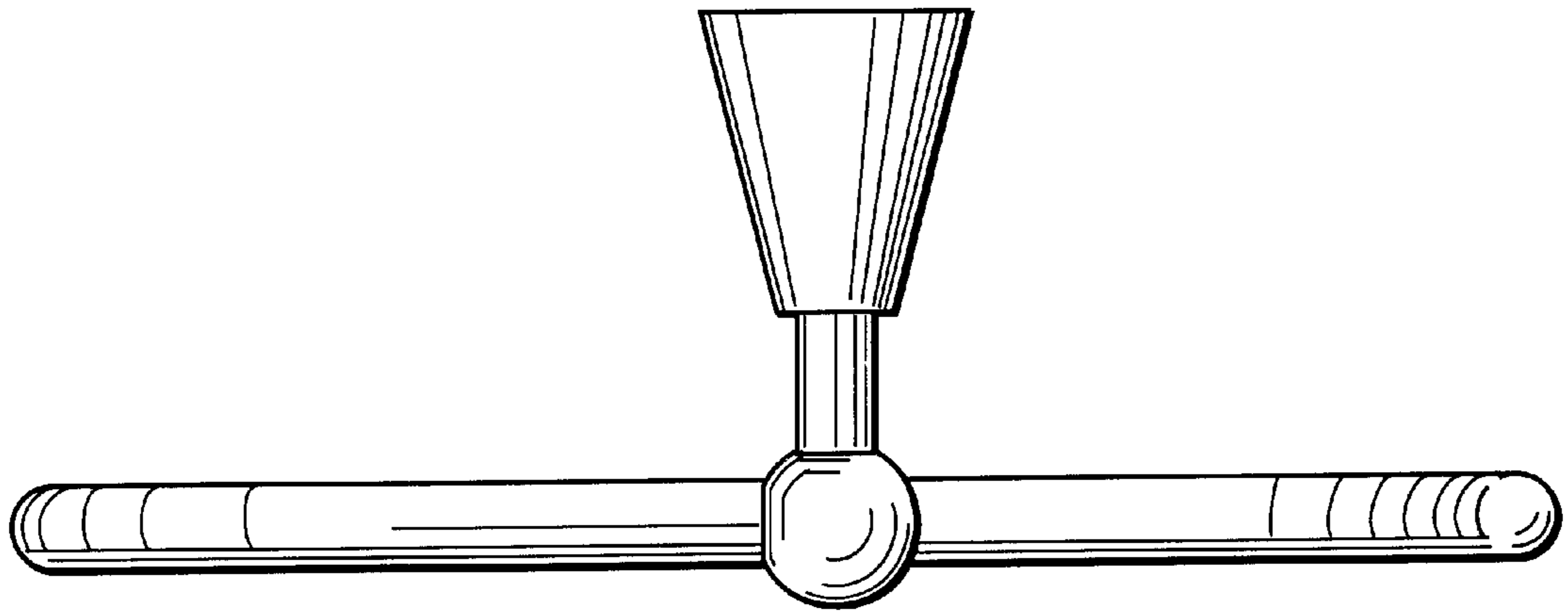

FIG. 2

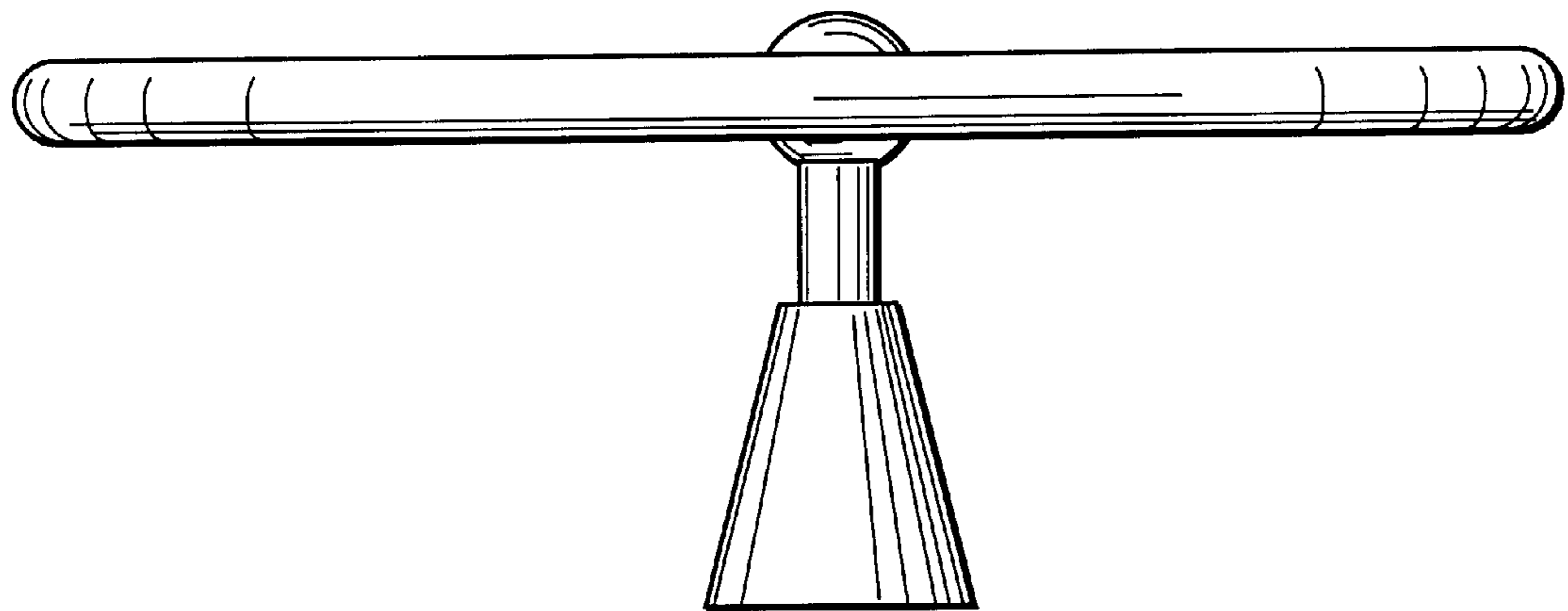

FIG. 3

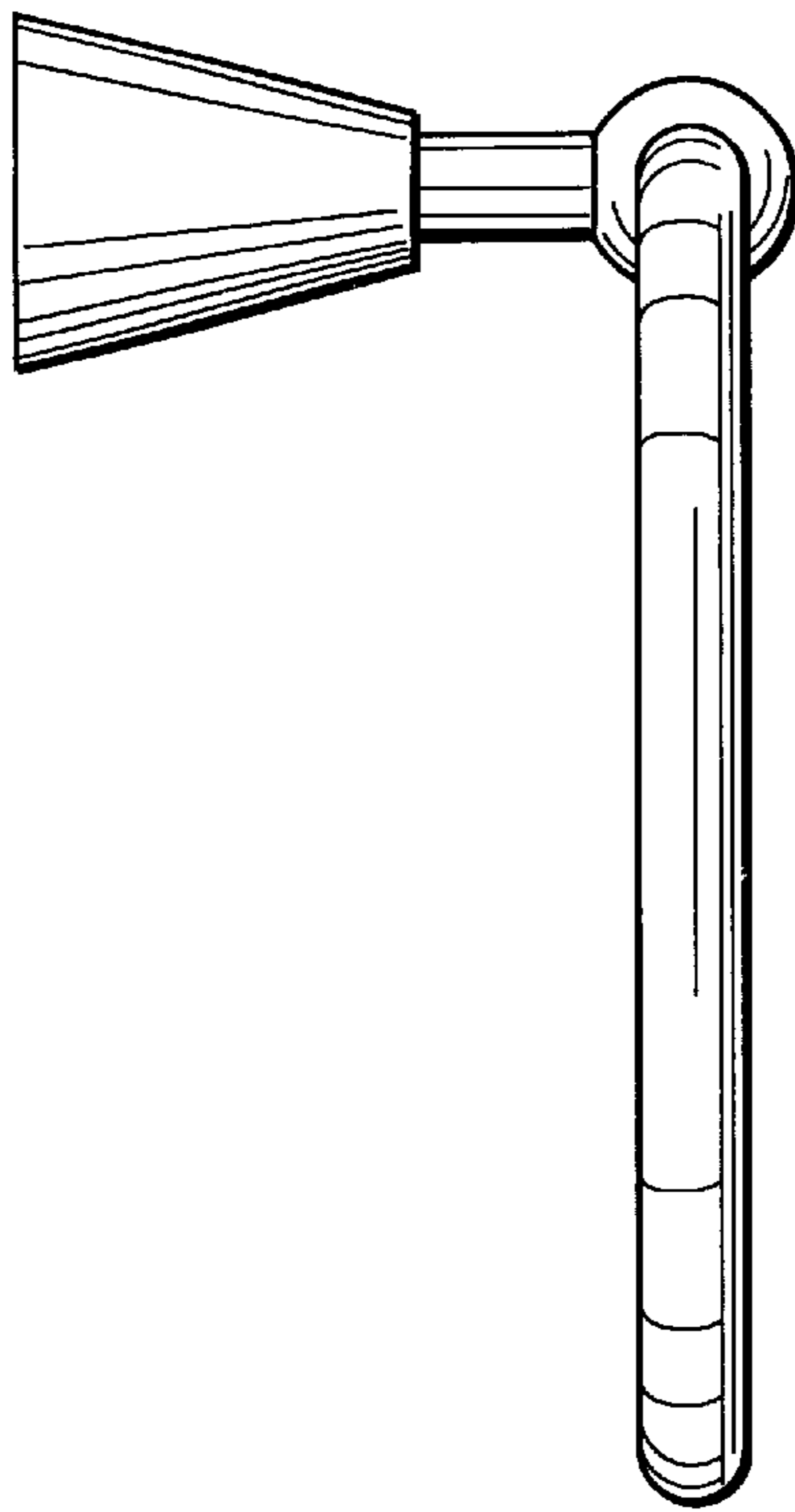

FIG. 4

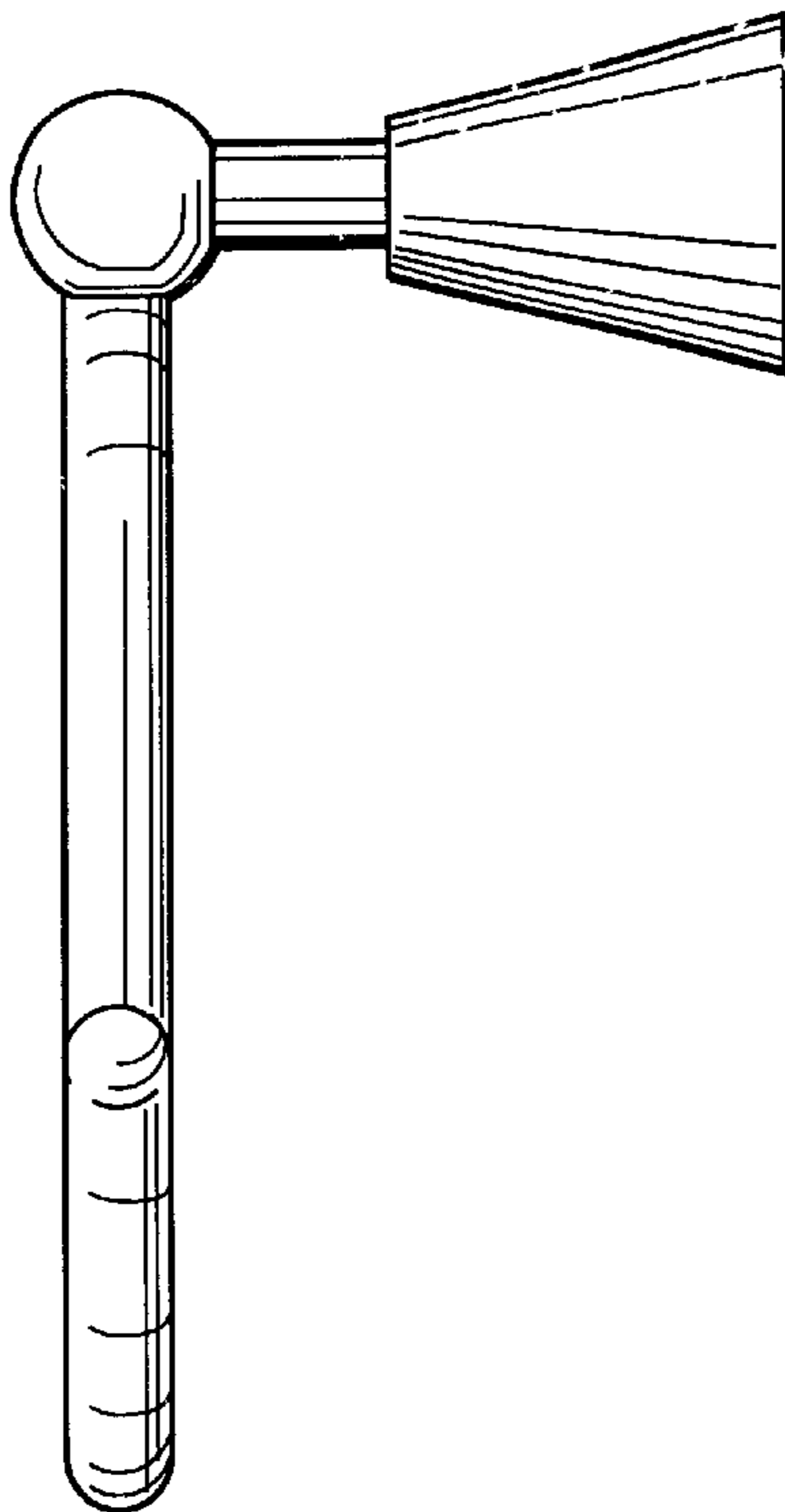

FIG. 5

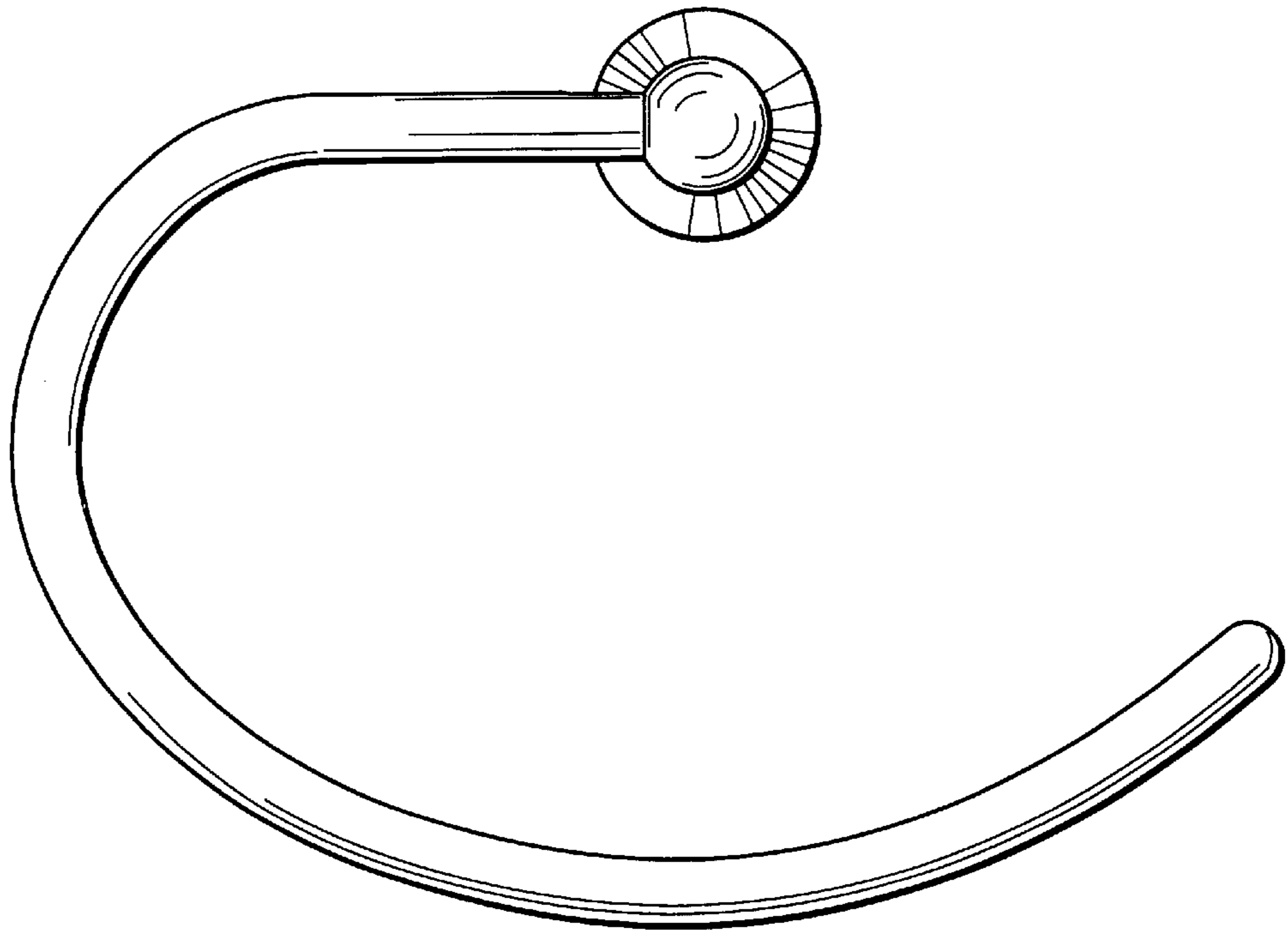

FIG. 6

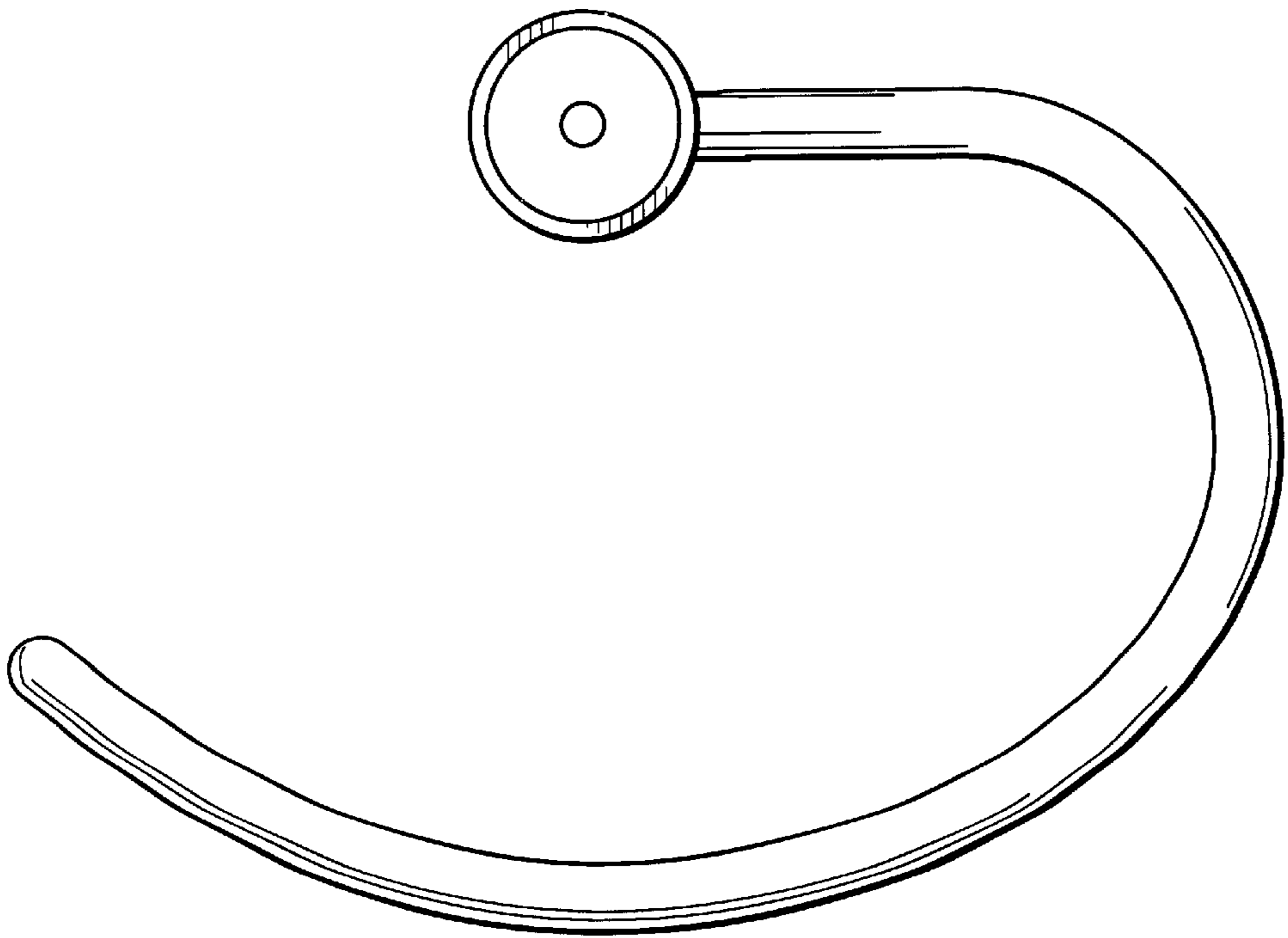

FIG. 7