



US00D464815S

(12) **United States Design Patent**
Mendonca

(10) **Patent No.:** **US D464,815 S**

(45) **Date of Patent:** **** Oct. 29, 2002**

(54) **CHAIR**

(76) Inventor: **Graziela H. Mendonca**, 6731 Shore Island Dr., Indianapolis, IN (US) 46202

(**) Term: **14 Years**

(21) Appl. No.: **29/148,615**

(22) Filed: **Sep. 24, 2001**

(51) **LOC (7) Cl.** **06-01**

(52) **U.S. Cl.** **D6/334; D6/363**

(58) **Field of Search** **D6/334, 363, 374, D6/375, 500, 501, 502; 297/445.1, 446.1, 451.3**

(56) **References Cited**

U.S. PATENT DOCUMENTS

D360,079 S	*	7/1995	Hienonimus	D6/334
D391,408 S	*	3/1998	Lee	D6/334
D405,274 S	*	2/1999	Smith	D6/334

* cited by examiner

Primary Examiner—Gary D. Watson

(74) *Attorney, Agent, or Firm*—Michael A. Myers; Bingham McHale LLP

(57) **CLAIM**

The ornamental design for a chair, as shown.

DESCRIPTION

FIG. 1 is an elevated perspective view of a chair showing my novel design;

FIG. 2 is a front view of the design shown in FIG. 1;

FIG. 3 is a top view of the design shown in FIG. 1;

FIG. 4 is a rear view of the design shown in FIG. 1;

FIG. 5 is a bottom view of the design shown in FIG. 1;

FIG. 6 is a side view of the design shown in FIG. 1; and,

FIG. 7 is the side opposite the view of the design shown in FIG. 6.

1 Claim, 4 Drawing Sheets

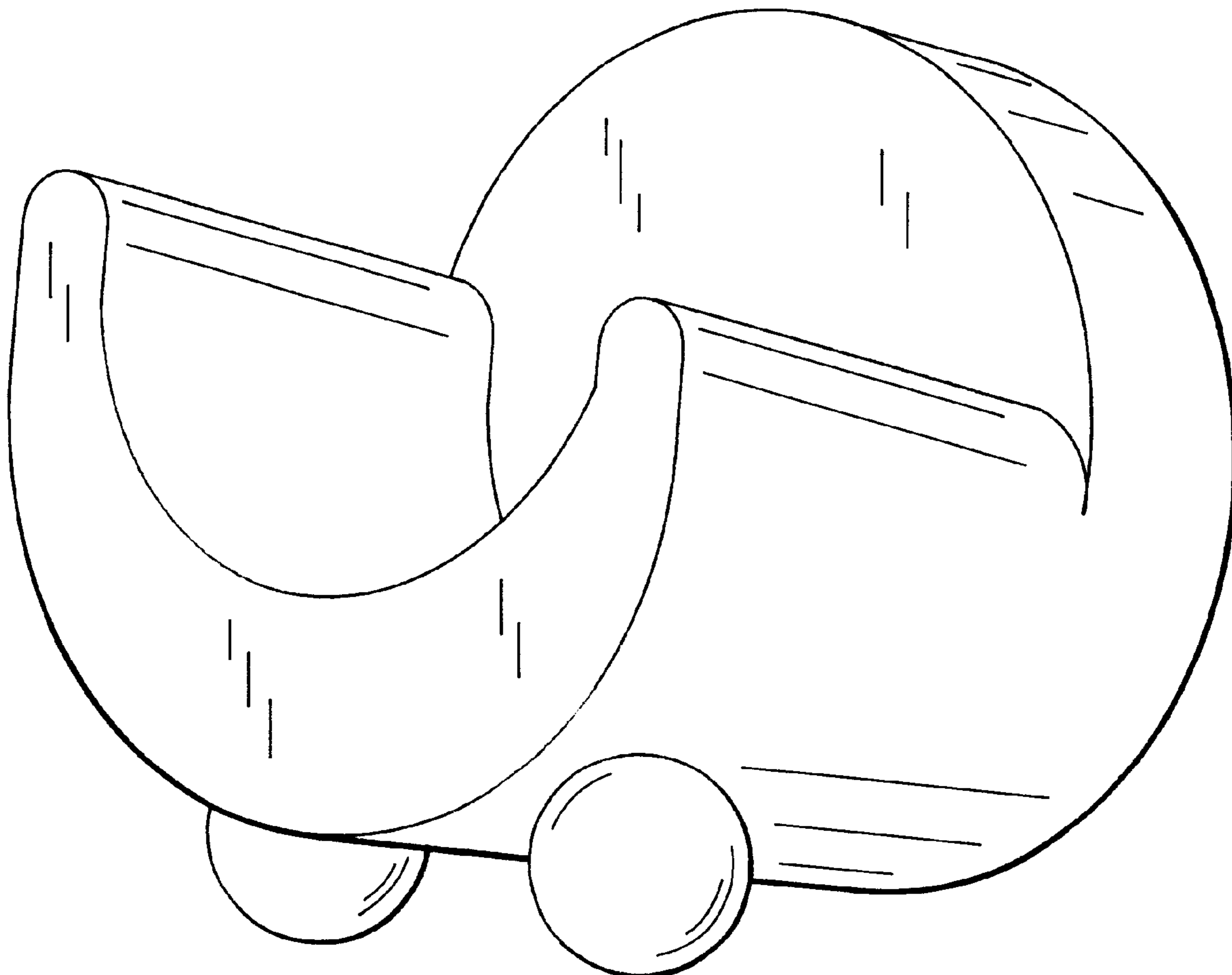

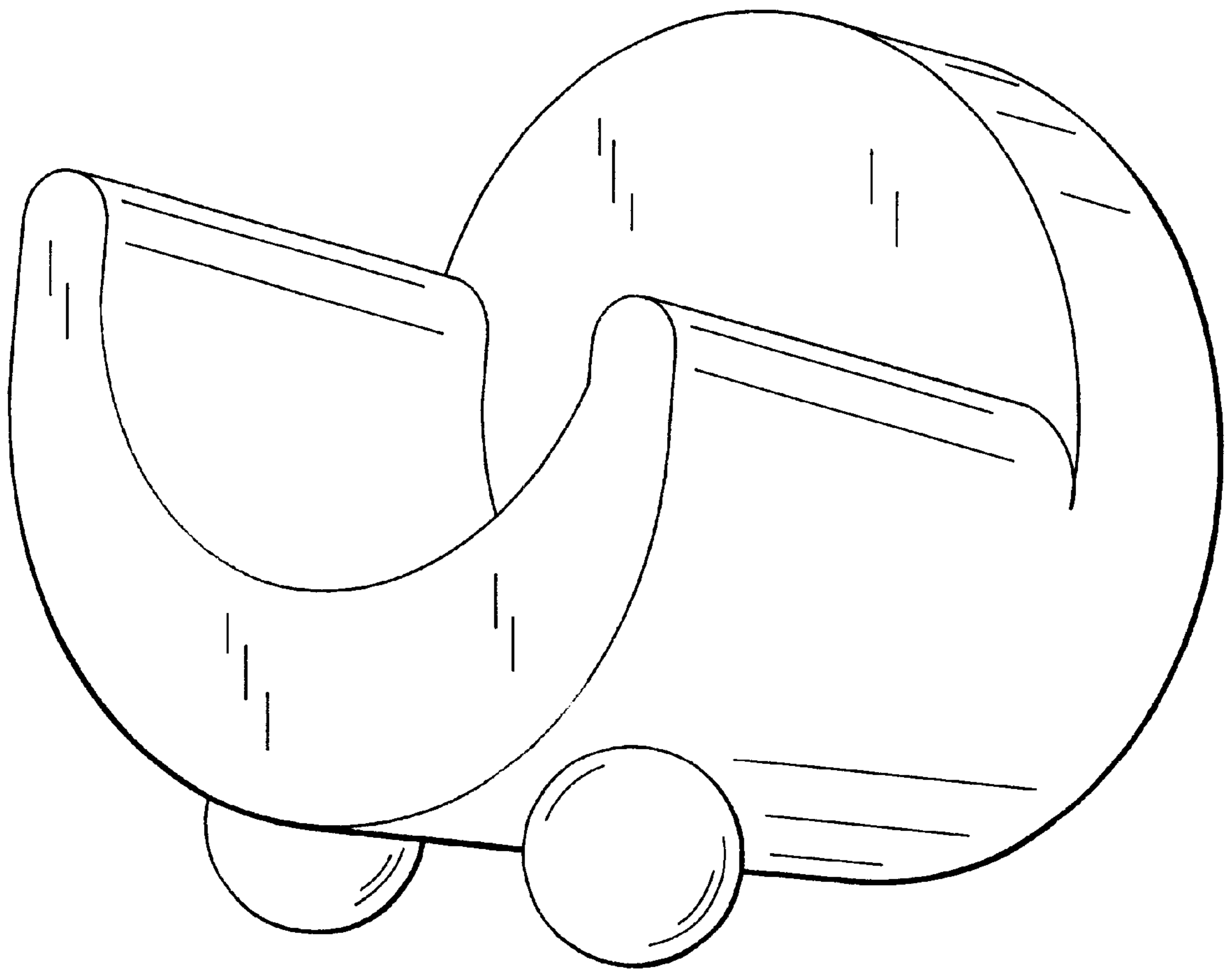

FIG. 1

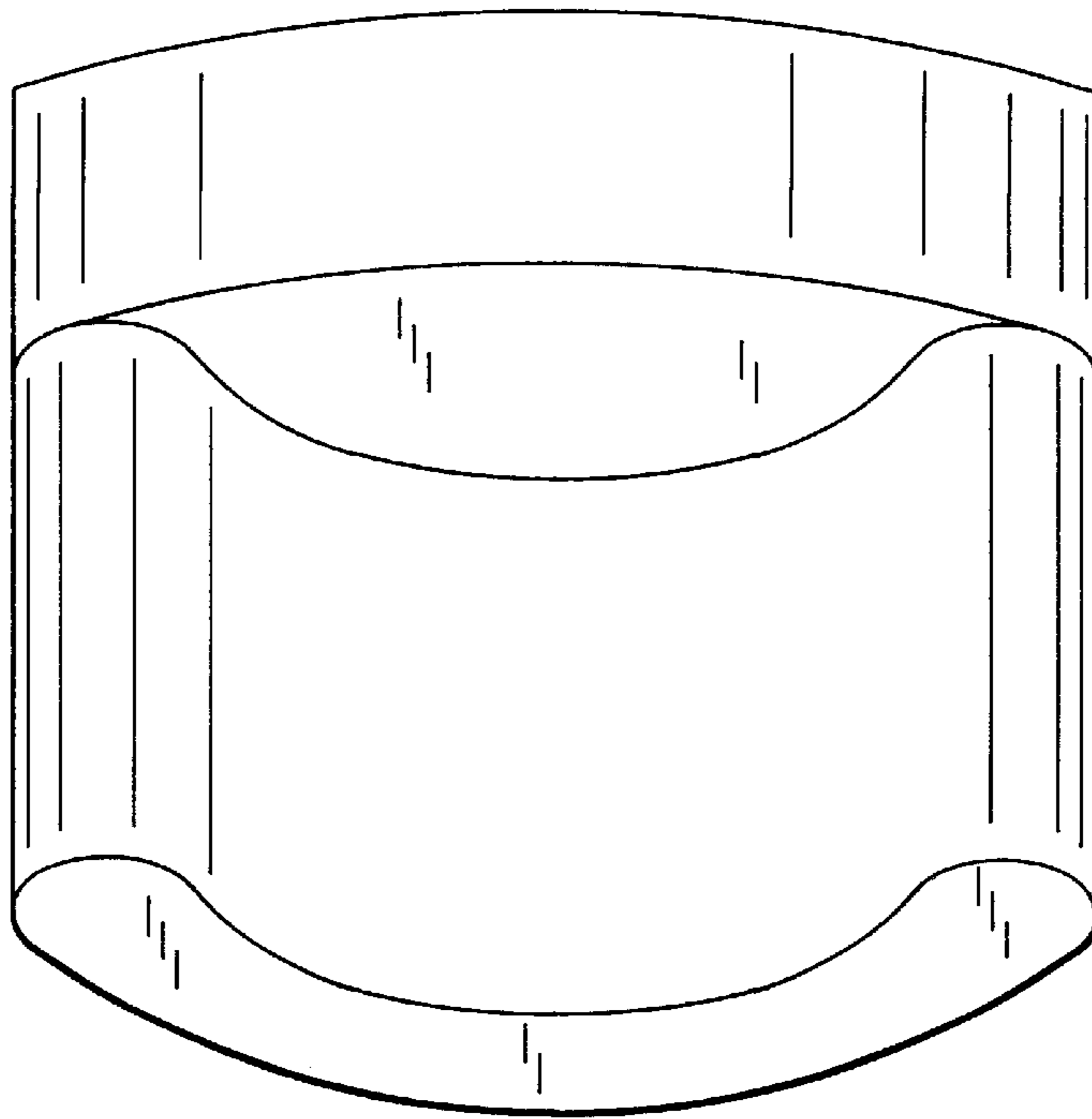

FIG. 3

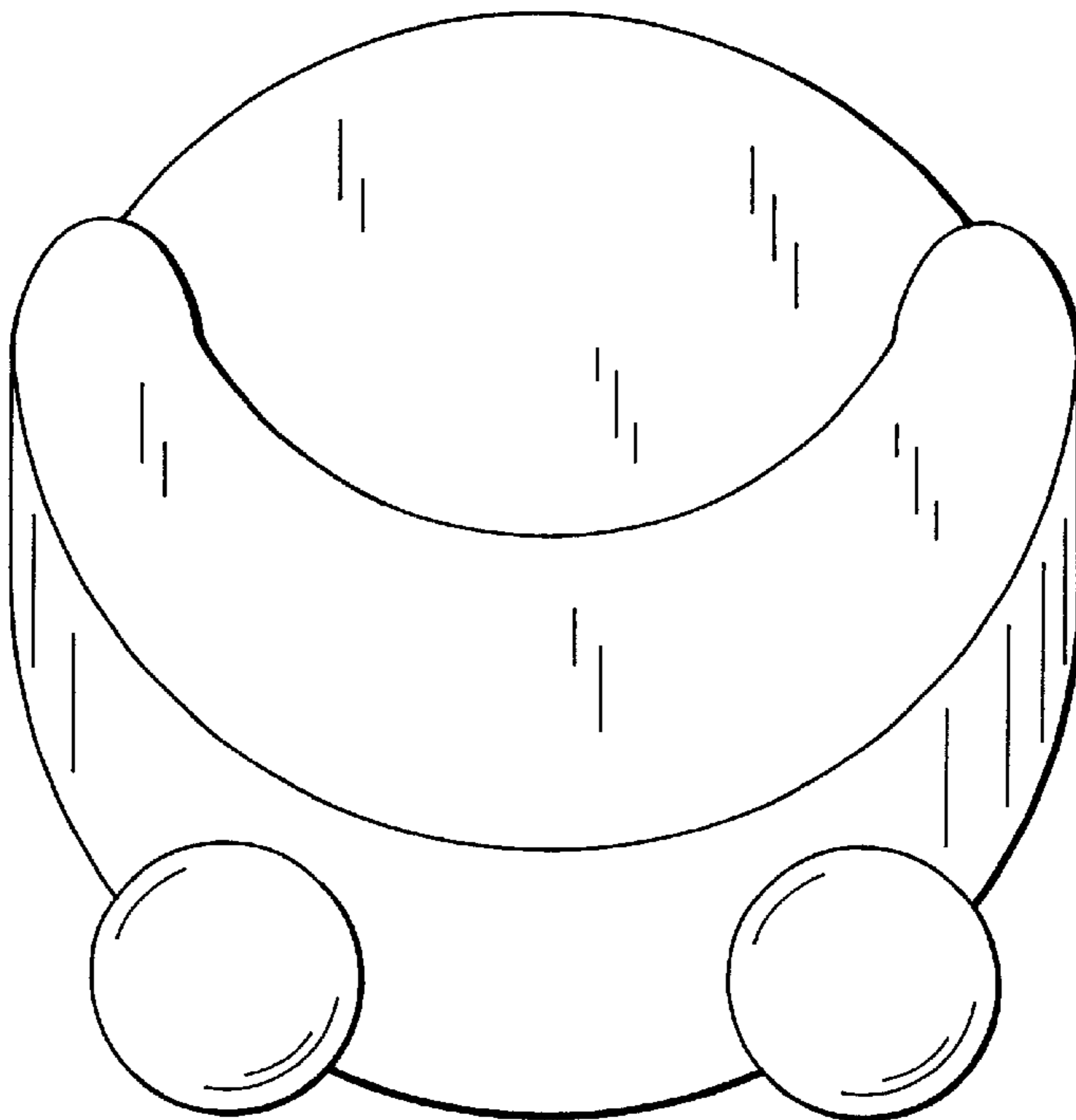

FIG. 2

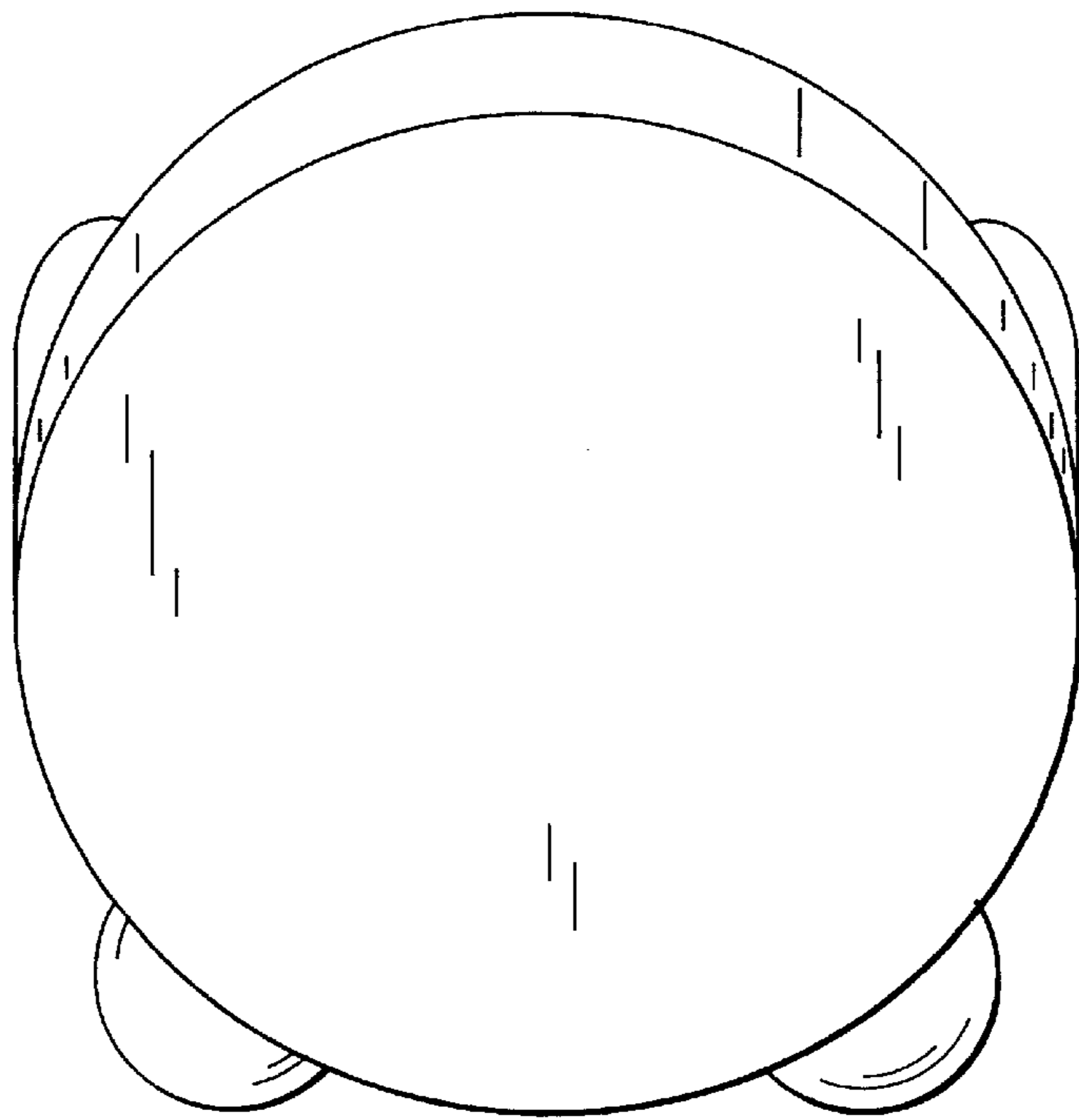

FIG. 4

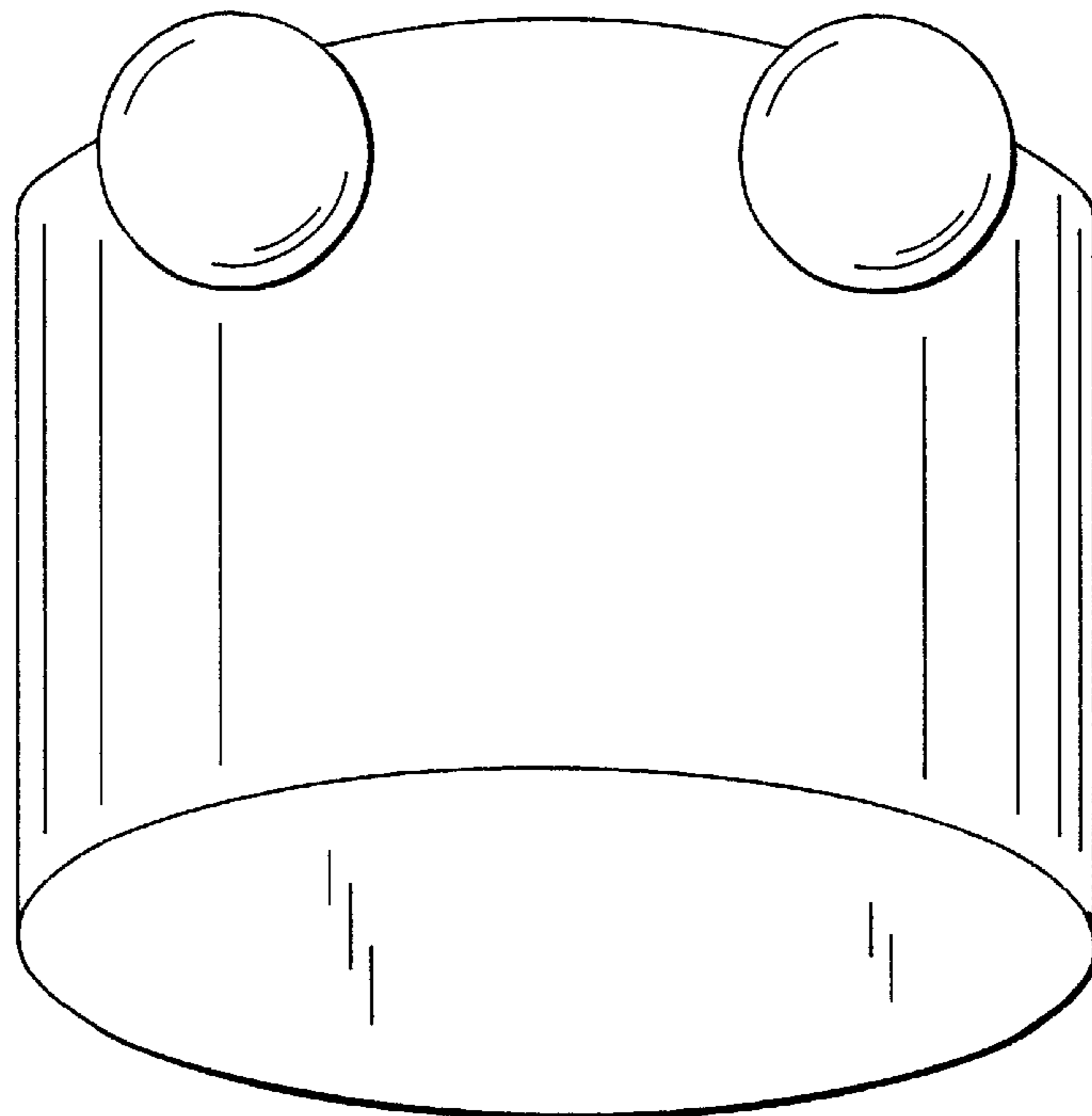

FIG. 5

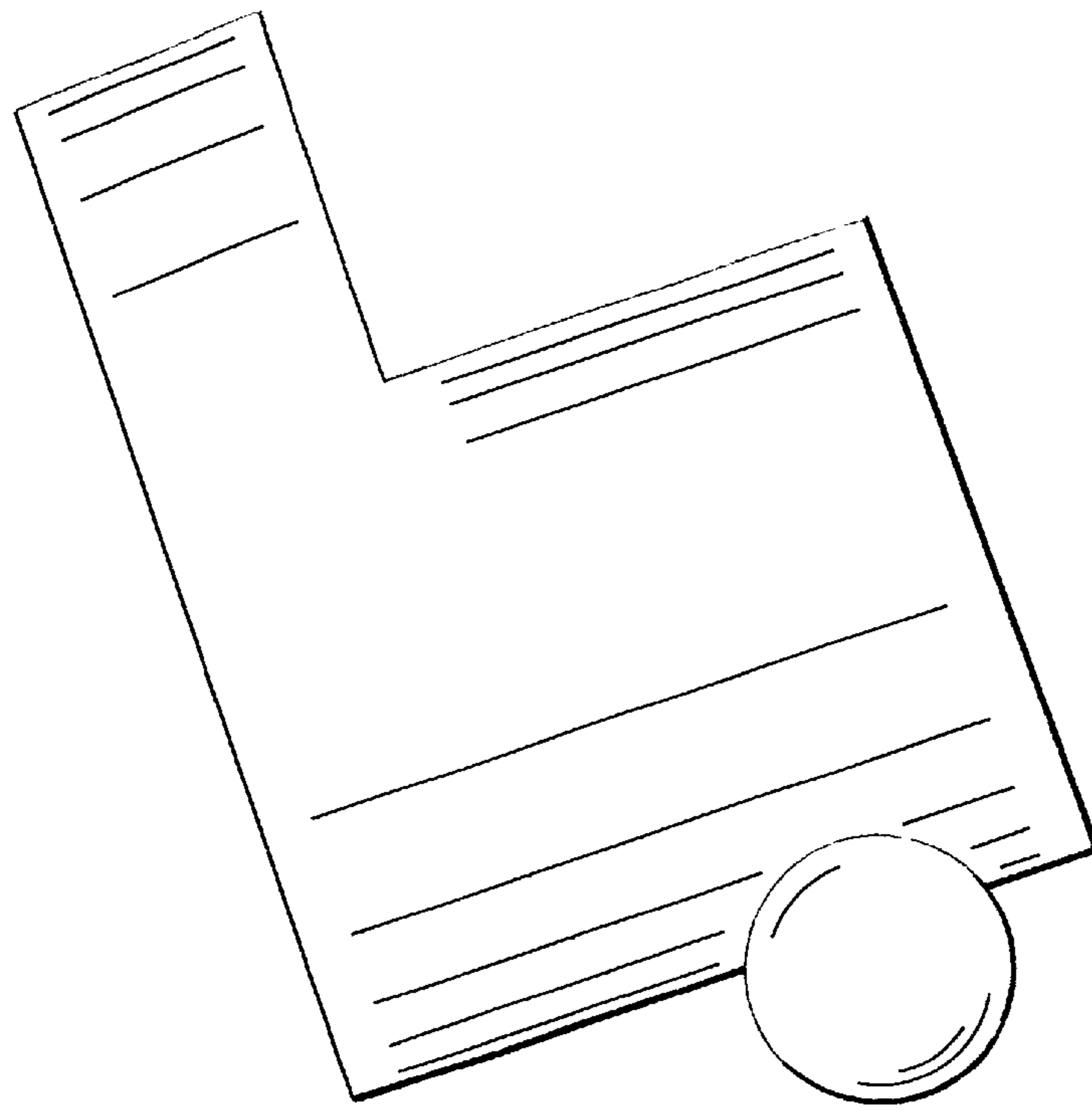

FIG. 6

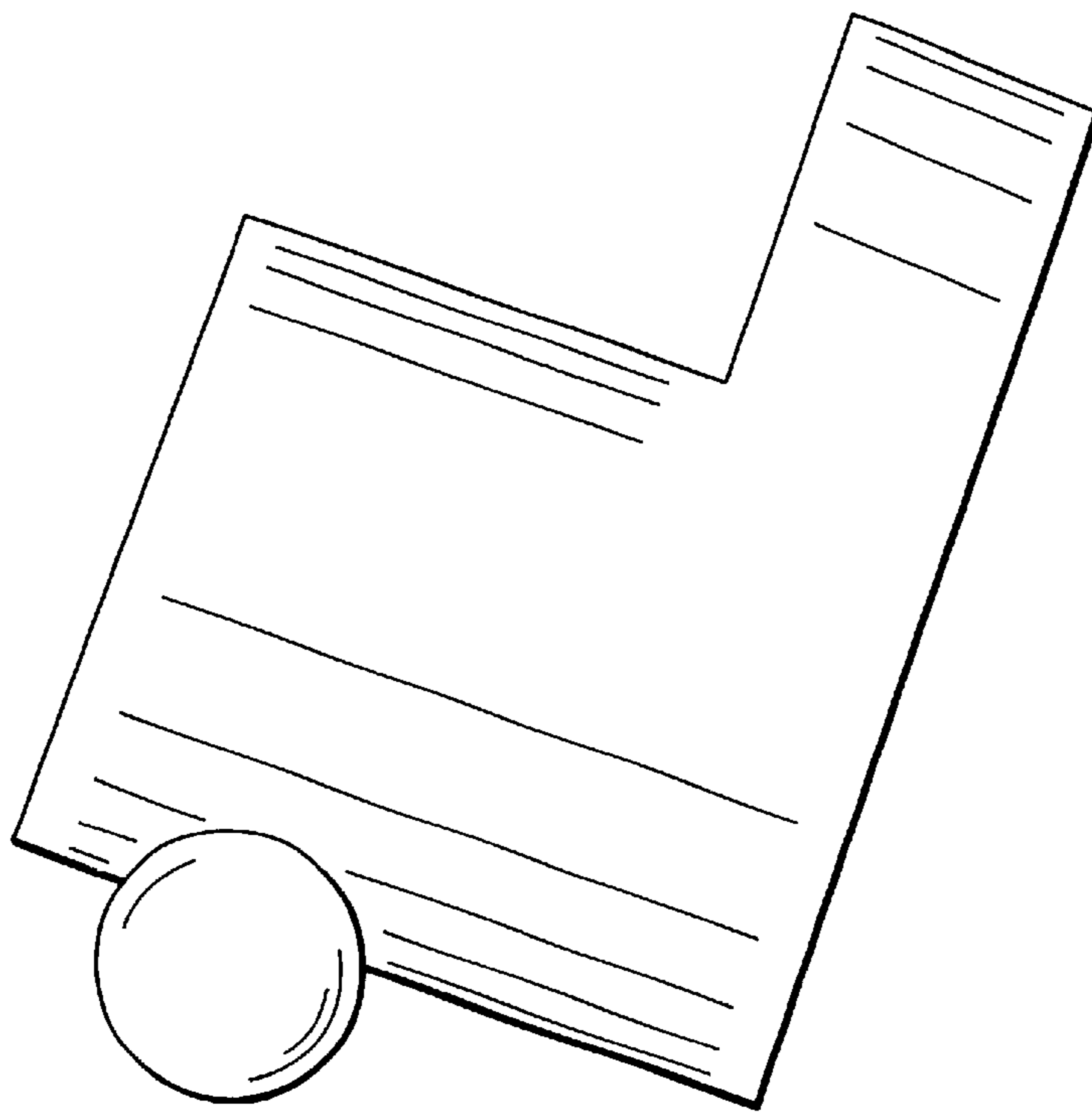

FIG. 7