



US00D464774S

(12) **United States Design Patent**
Kay

(10) **Patent No.:** **US D464,774 S**

(45) **Date of Patent:** **** Oct. 22, 2002**

(54) **SONIC CLEANER**

(75) **Inventor:** **Neil J. Kay**, Rolling Hills Estates, CA (US)

(73) **Assignee:** **Cisco Sales Corp.**, Torrance, CA (US)

(**) **Term:** **14 Years**

(21) **Appl. No.:** **29/156,806**

(22) **Filed:** **Mar. 11, 2002**

(51) **LOC (7) Cl.** **15-05**

(52) **U.S. Cl.** **D32/1**

(58) **Field of Search** D32/1; 366/110-118, 366/127; 134/135, 164, 182-184, 1

(56) **References Cited**

U.S. PATENT DOCUMENTS

3,135,987	A	*	6/1964	Huch	15/104.92
3,432,148	A	*	3/1969	Krolik	366/110
3,606,274	A	*	9/1971	Nelson	366/293
3,771,772	A	*	11/1973	Honda	366/110
4,442,852	A	*	4/1984	Lord	134/135
D300,677	S	*	4/1989	Hoye	D32/1
D315,039	S	*	2/1991	Wortham	D32/1
D315,815	S	*	3/1991	Miller	D32/1
D343,704	S	*	1/1994	Bucher	D32/1
6,076,538	A	*	6/2000	Frankson	134/117

* cited by examiner

Primary Examiner—Nelson C. Holtje
(74) *Attorney, Agent, or Firm*—Irving Keschner

(57) **CLAIM**

The ornamental design for a sonic cleaner, as shown.

DESCRIPTION

FIG. 1 is a front perspective view of a sonic cleaner showing my new ornamental design;
 FIG. 2 is a top view of the ornamental design shown in FIG. 1;
 FIG. 3 is a first front elevational view of the ornamental design shown in FIG. 1;
 FIG. 4 is a second front elevation view of the ornamental design shown in FIG. 1;
 FIG. 5 is a rear elevational view of the ornamental design shown in FIG. 1;
 FIG. 6 is a bottom view of the ornamental design shown in FIG. 1;
 FIG. 7 is a perspective view of the ornamental design of the present invention shown in FIG. 1 with the top cover removed;
 FIG. 8 is a top view of the ornamental design shown in FIG. 7;
 FIG. 9 is a first elevation view of the ornamental design shown in FIG. 7;
 FIG. 10 is a second elevation view of the ornamental design shown in FIG. 7;
 FIG. 11 is a rear elevational view of the ornamental design shown in FIG. 7; and,
 FIG. 12 is a bottom view of the ornamental design shown in FIG. 7.

1 Claim, 4 Drawing Sheets

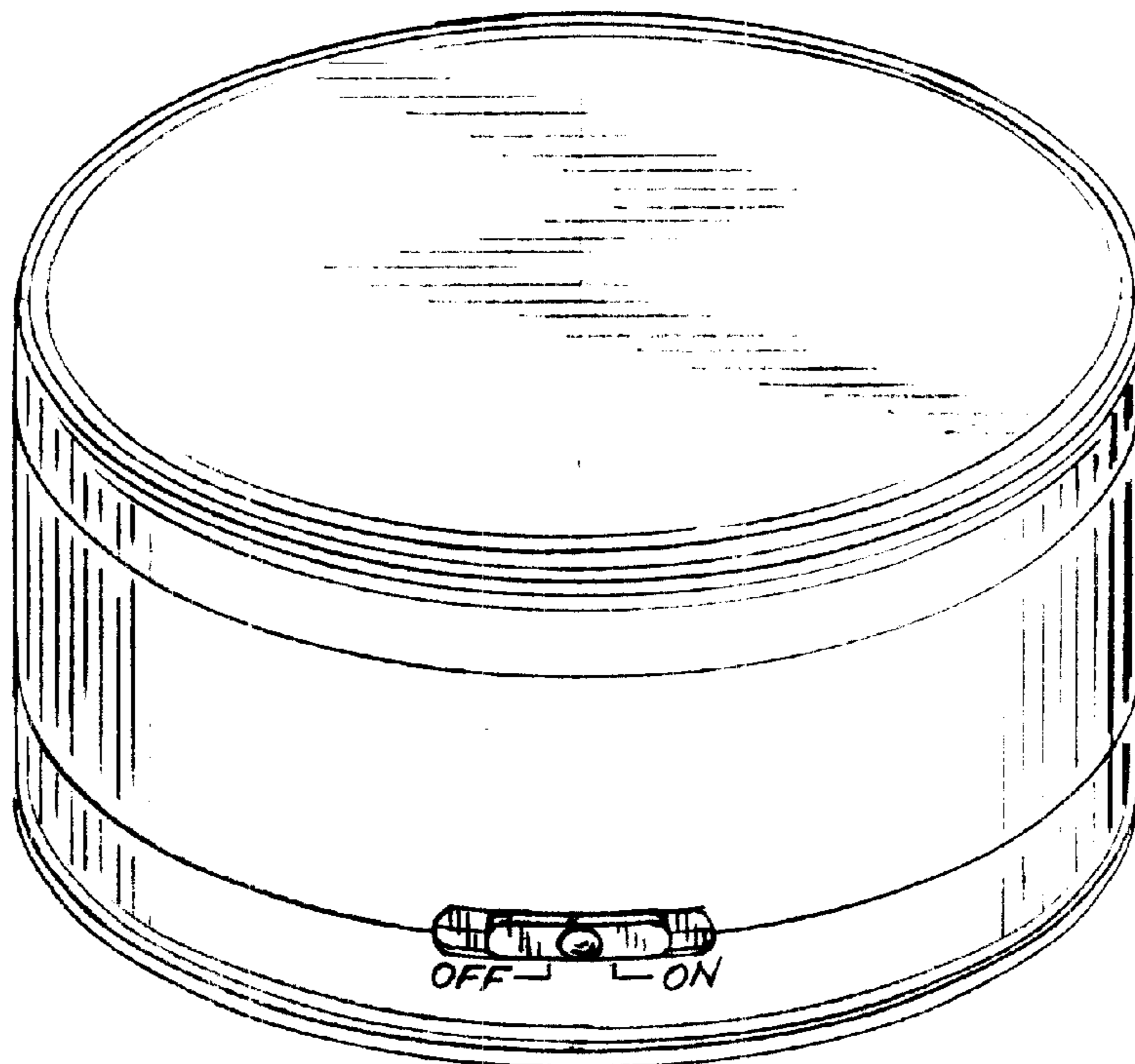

FIG. 1

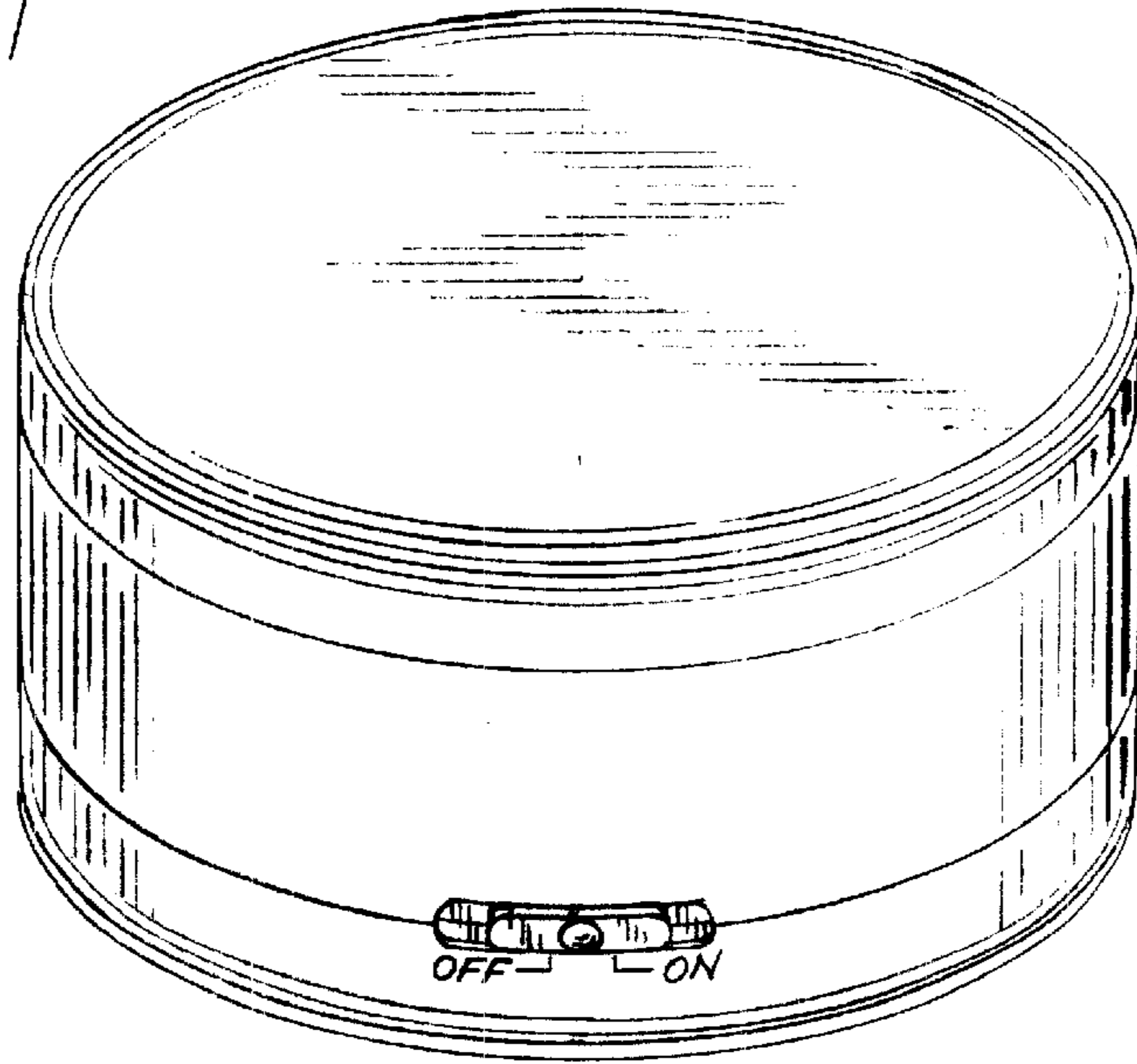

FIG. 2

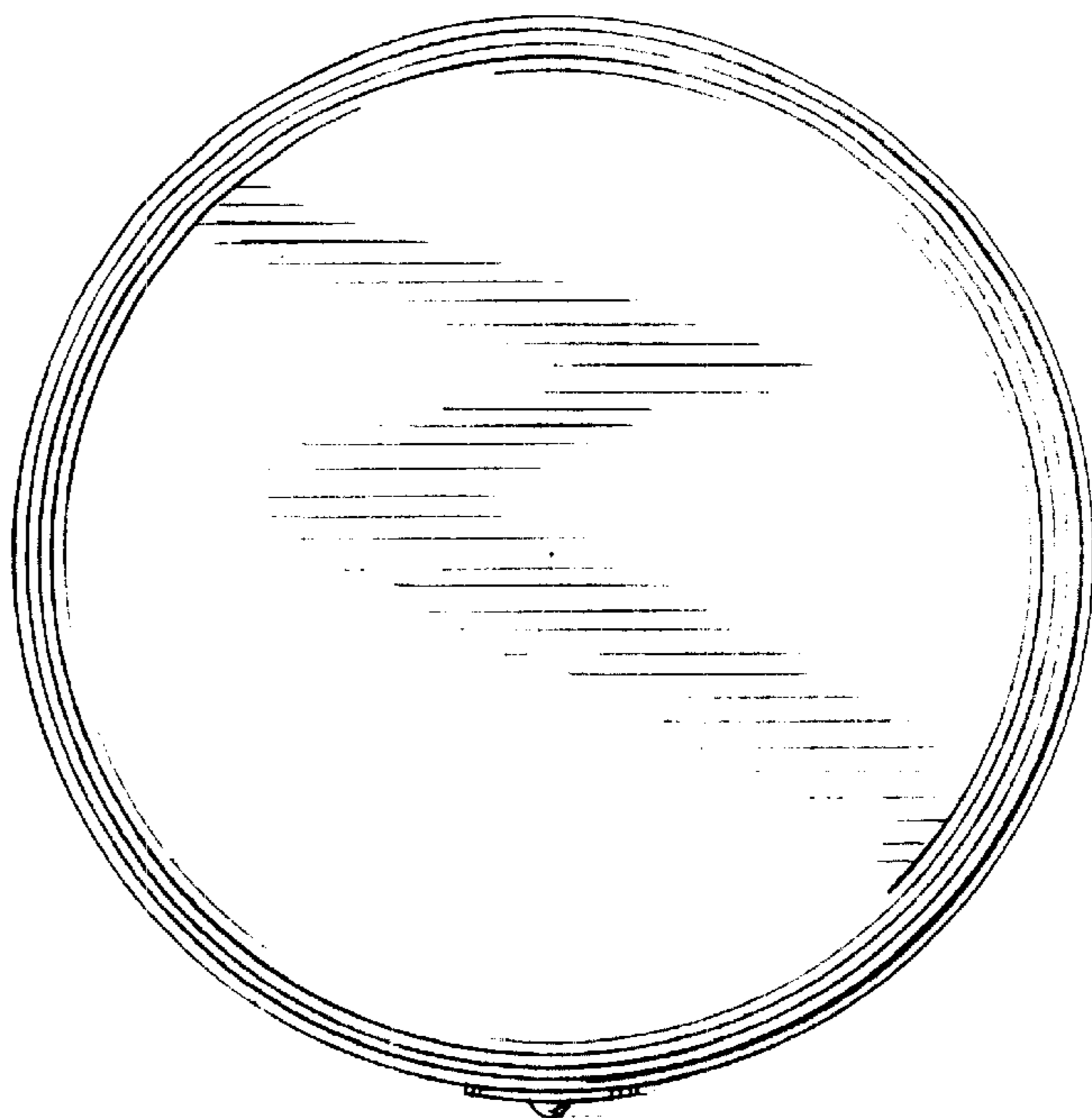

FIG. 3

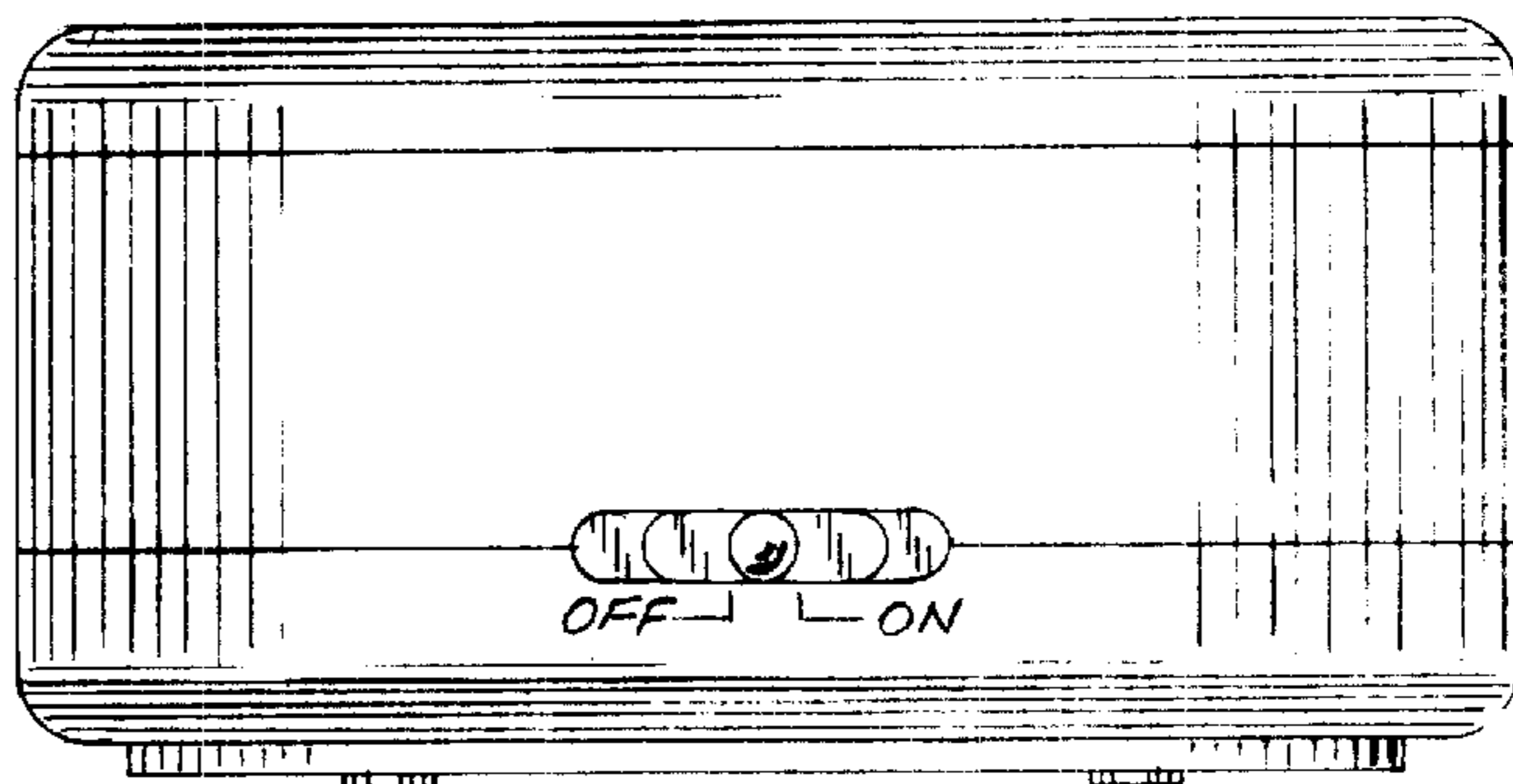

FIG. 4

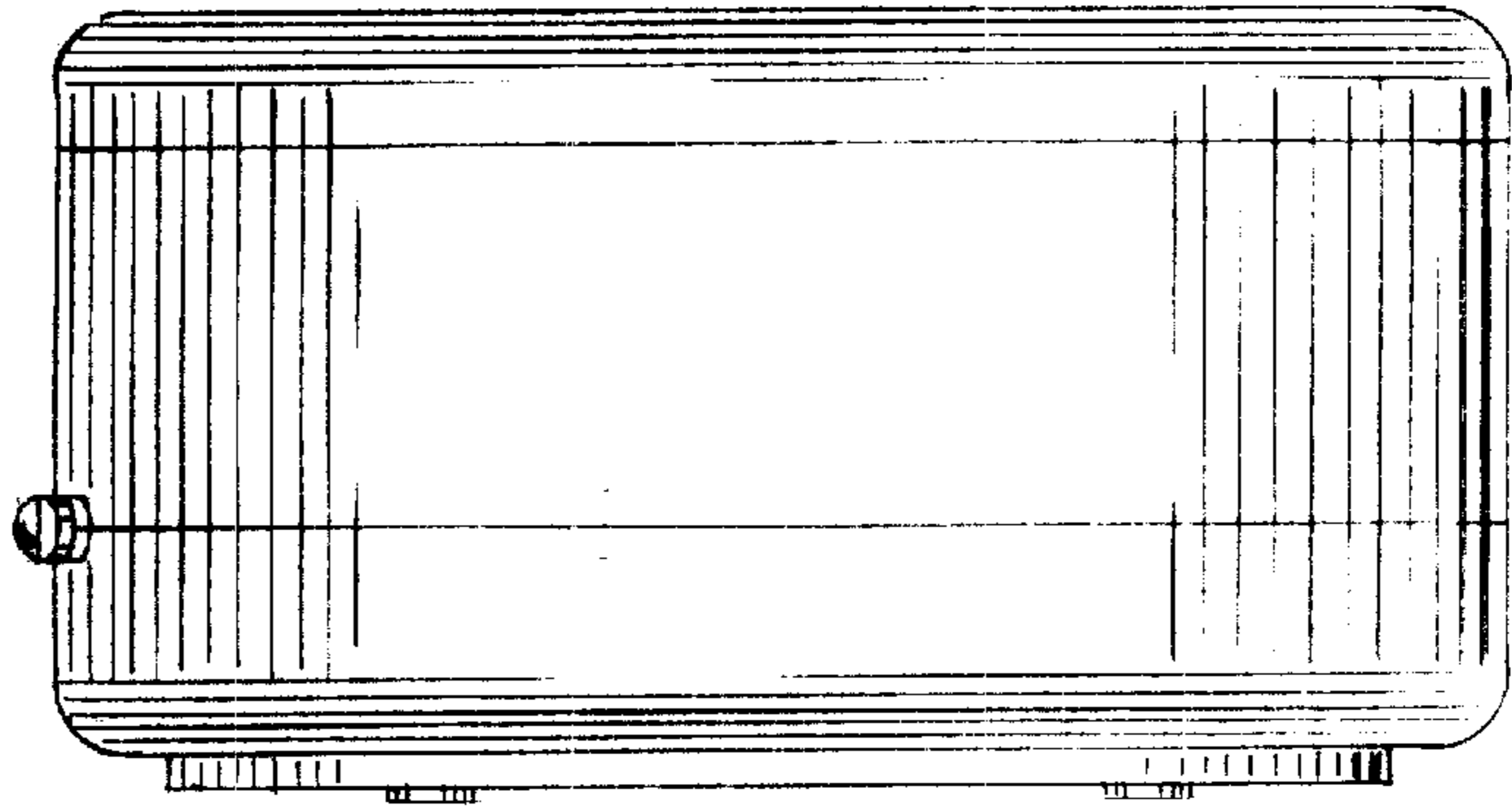

FIG. 5

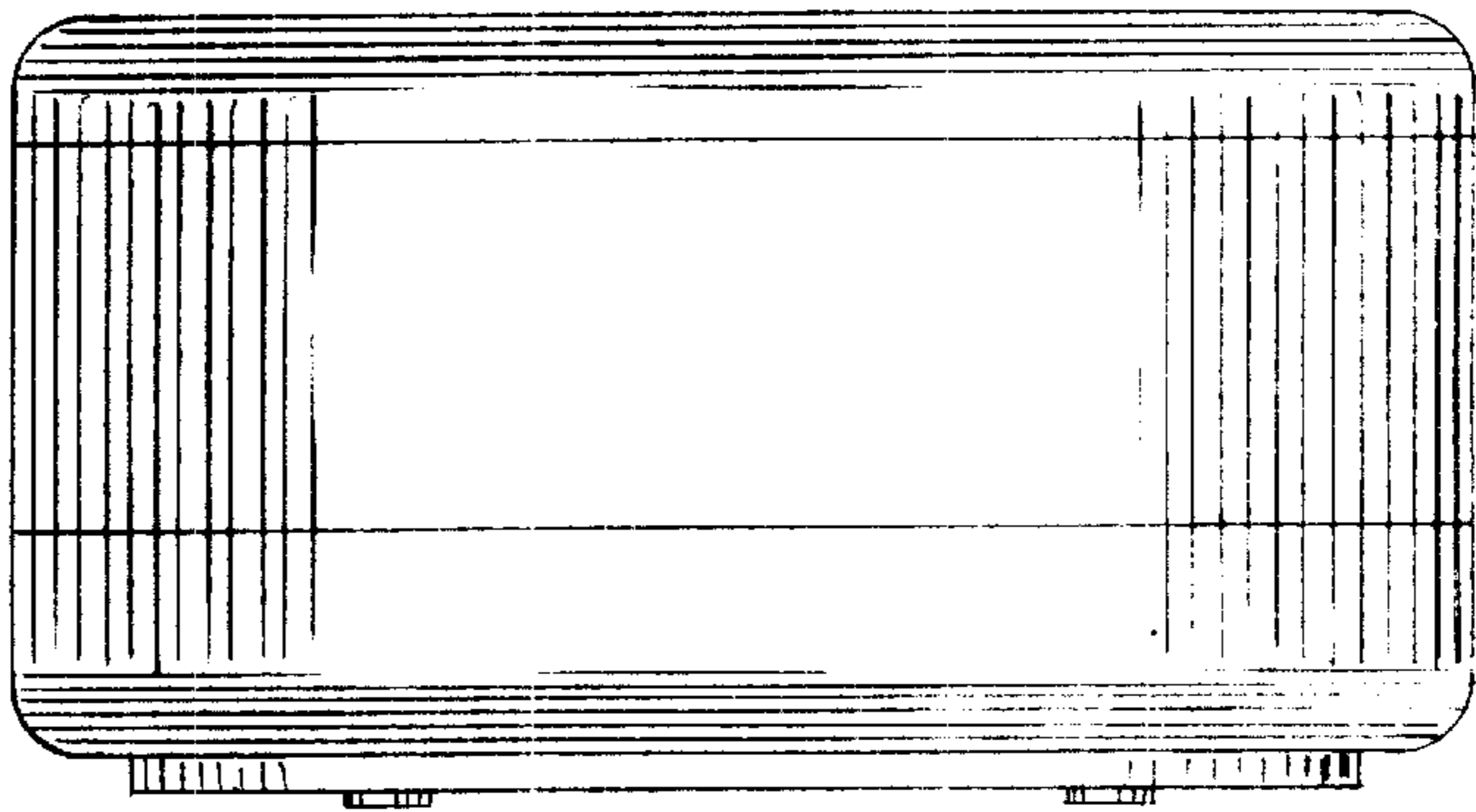

FIG. 6

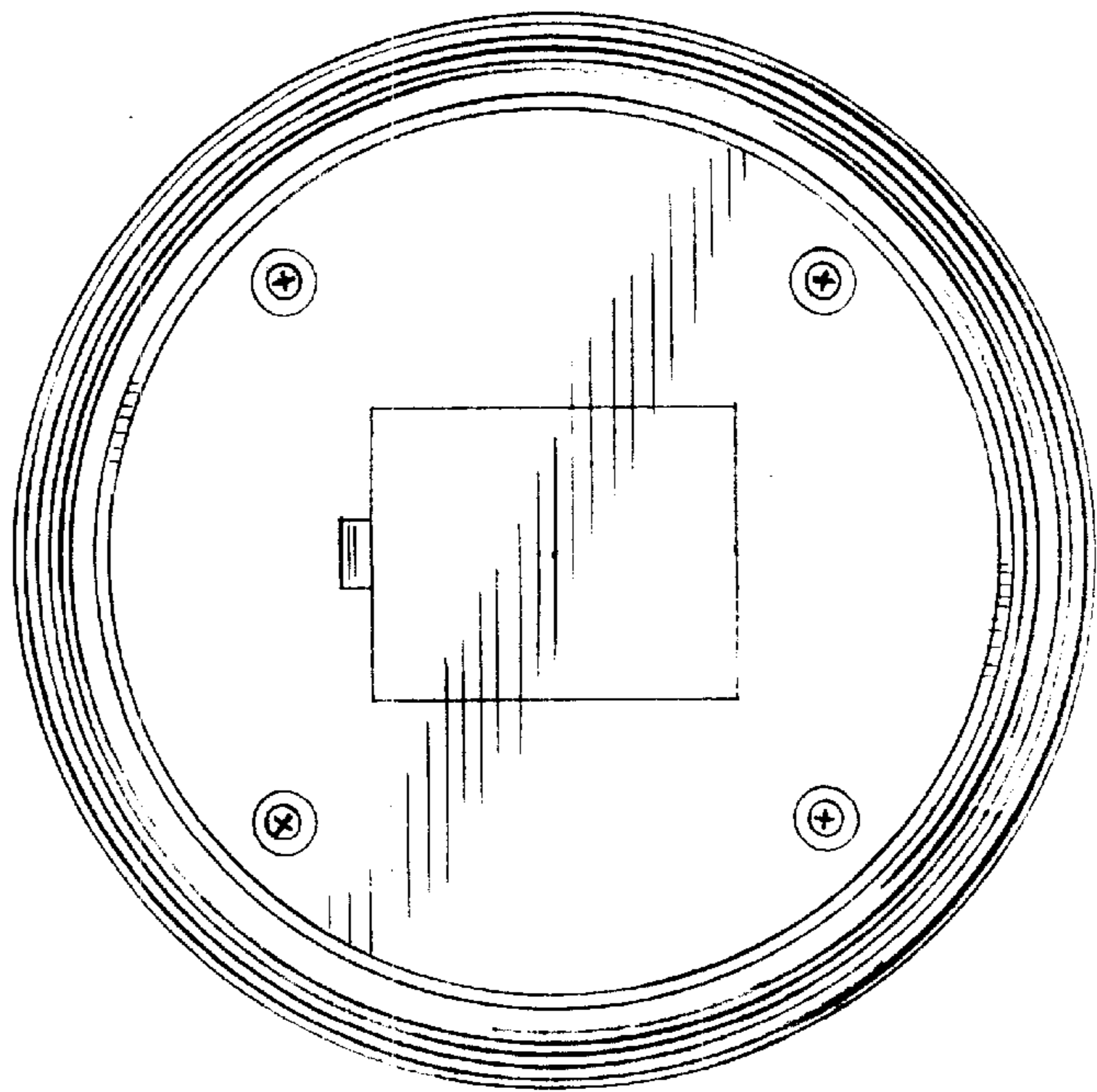

FIG. 7

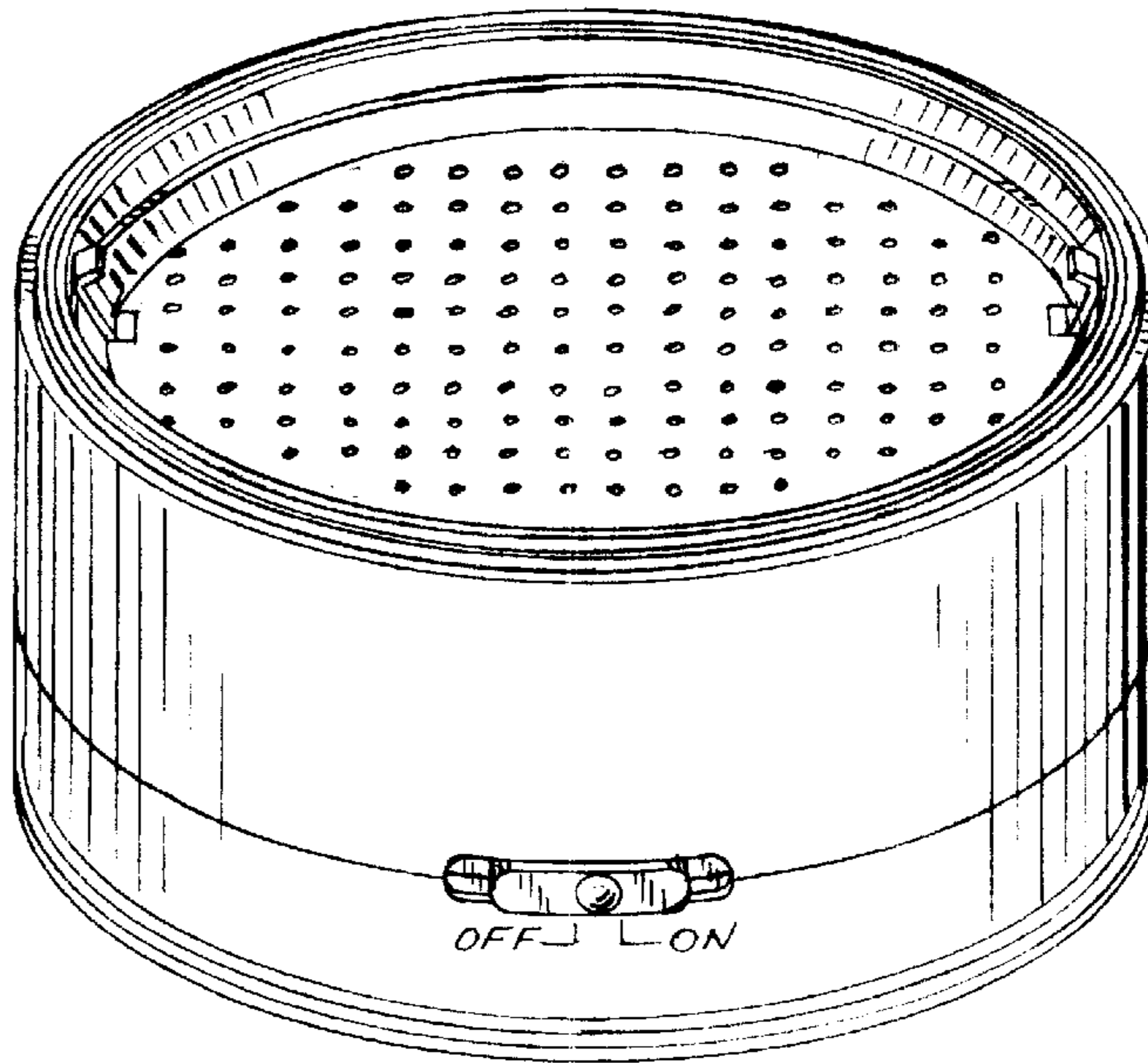

FIG. 8

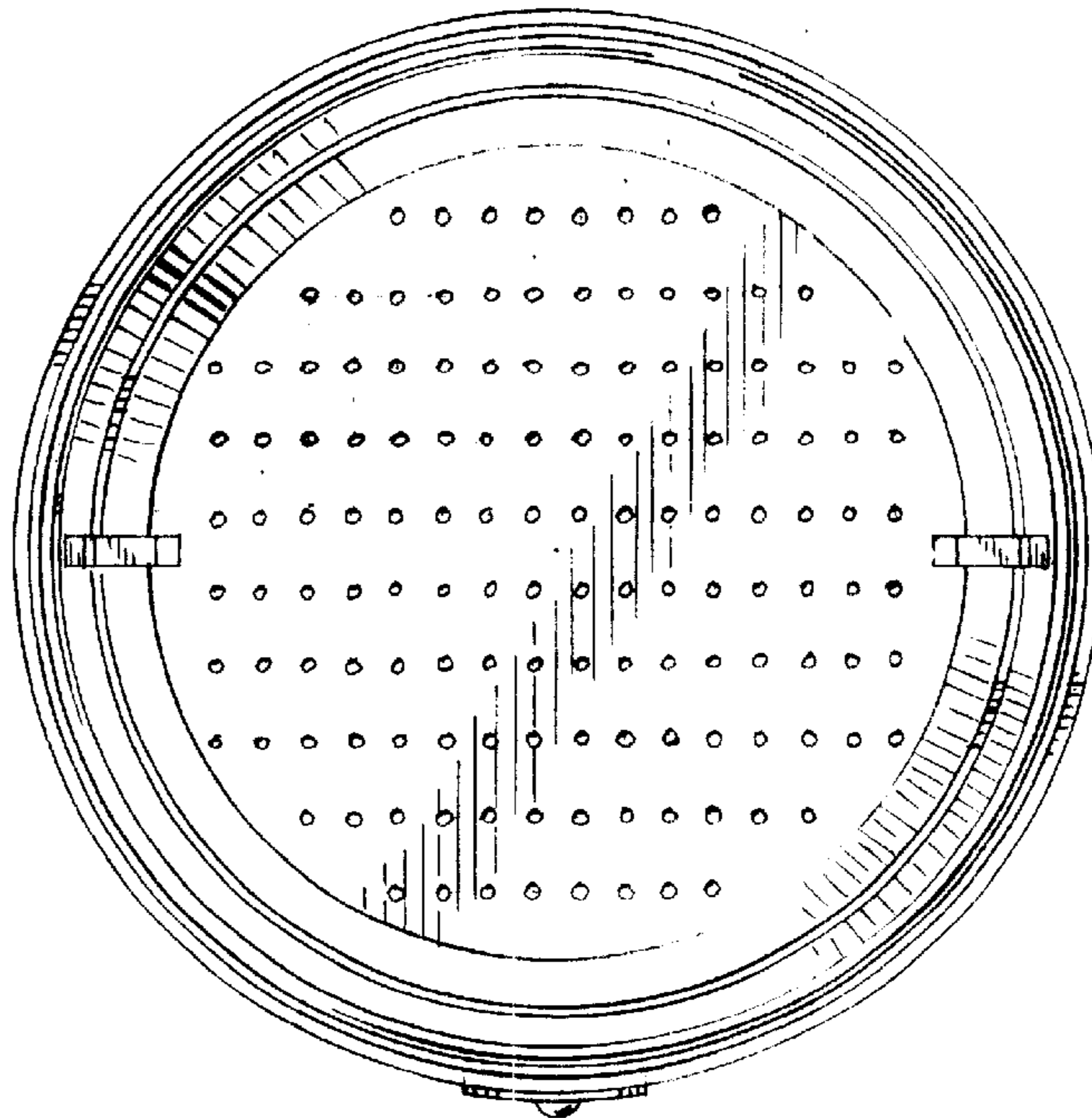

FIG. 9

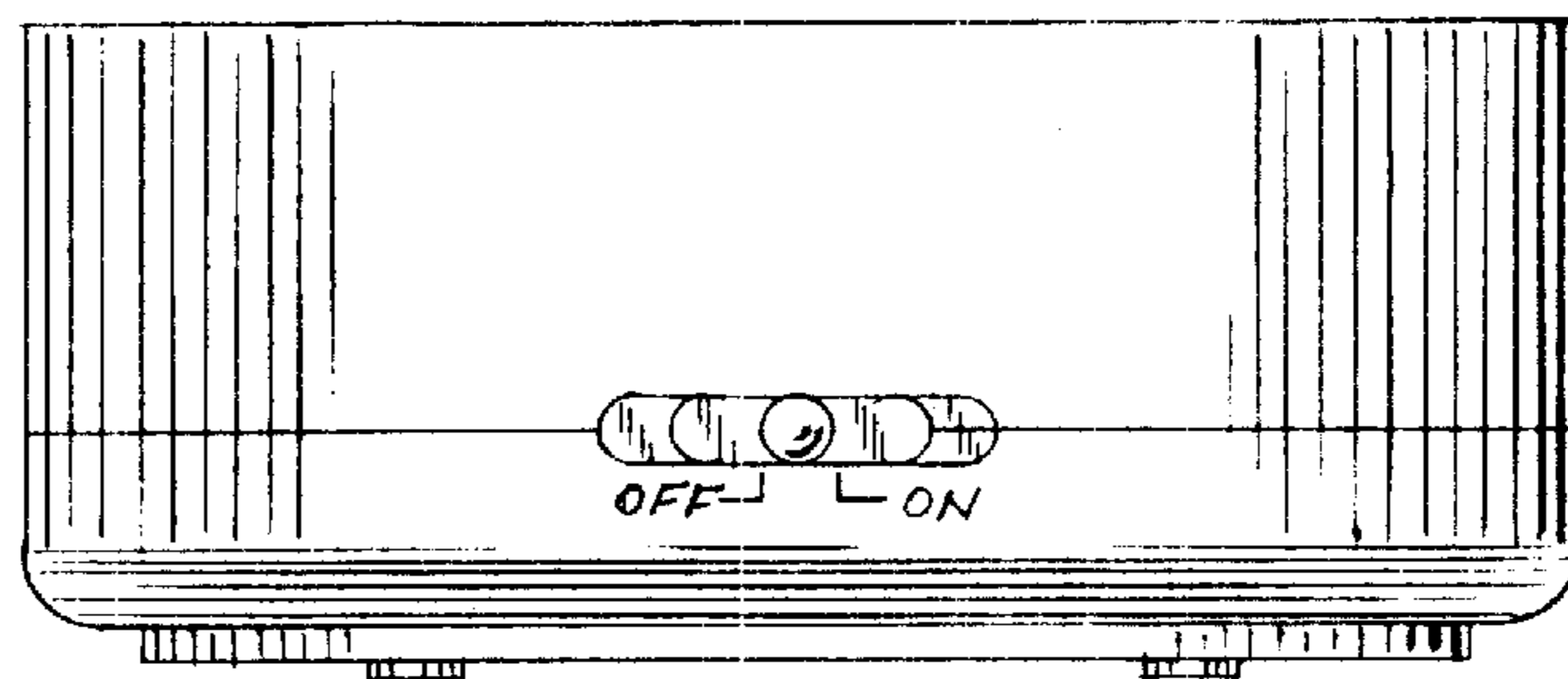

FIG. 10

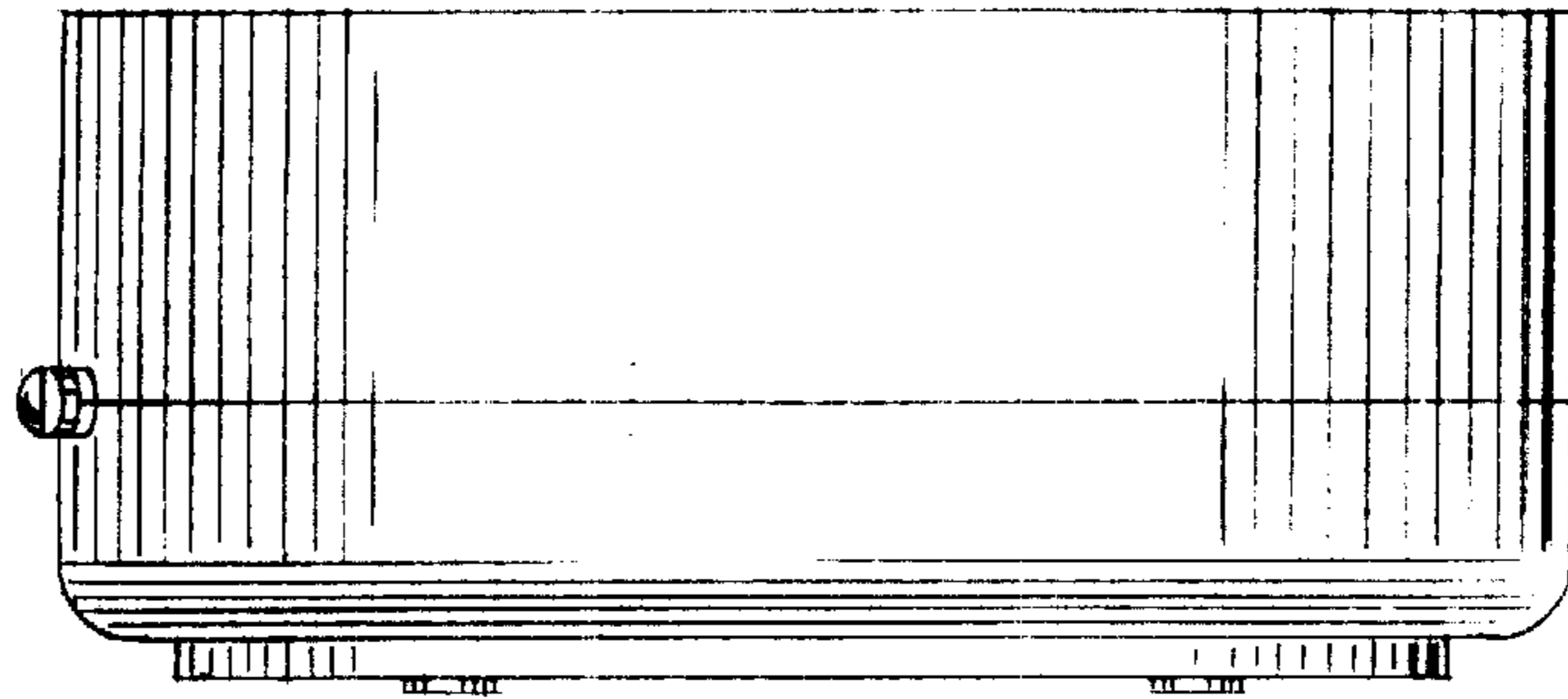

FIG. 11

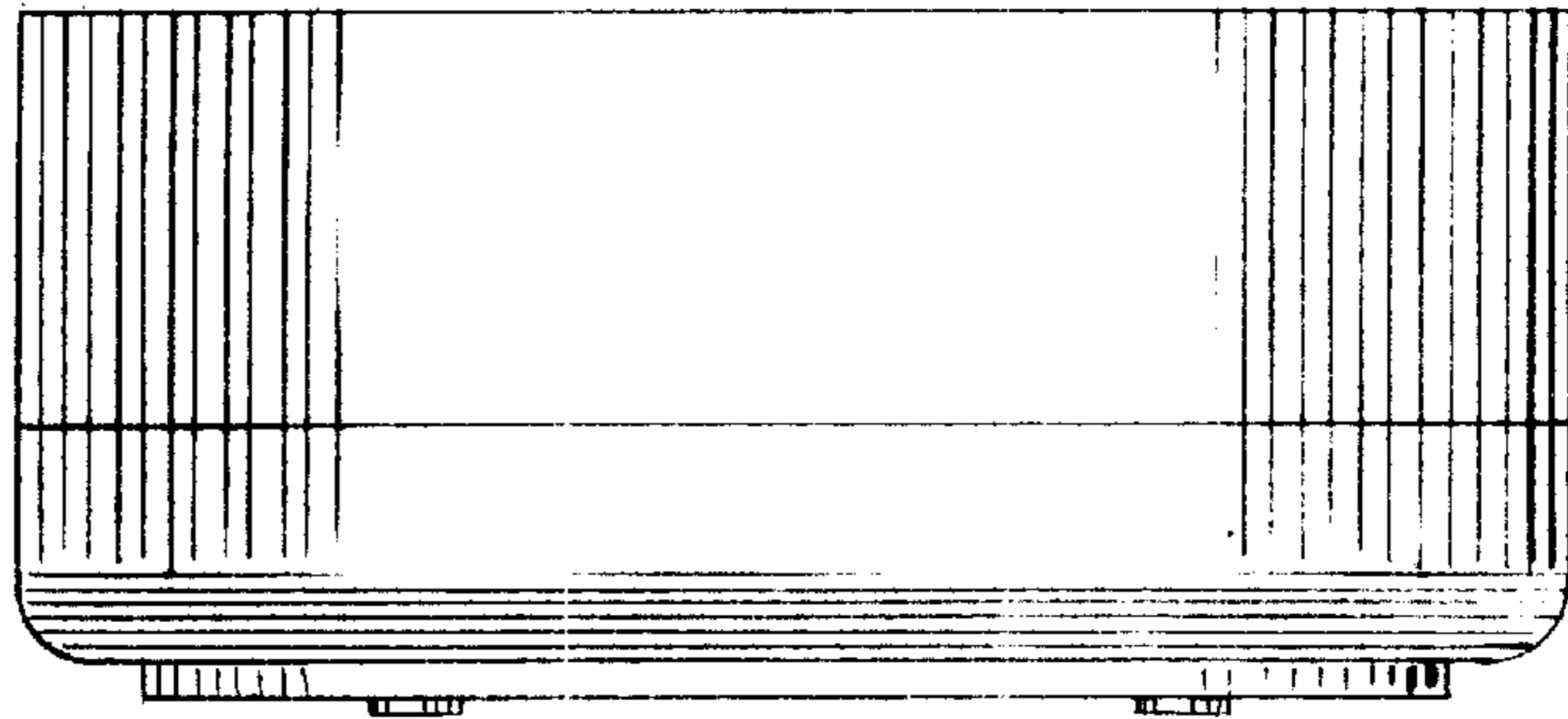

FIG. 12

