



US00D464697S

(12) **United States Design Patent**  
**Yang**

(10) **Patent No.:** **US D464,697 S**

(45) **Date of Patent:** **\*\* Oct. 22, 2002**

(54) **SKATE BASE**

D410,268 S \* 5/1999 Yung ..... D21/763

(76) Inventor: **Lien-Chuan Yang**, 11F-1, No. 149,  
Roosevelt Rd. Sec. 3, Taipei (TW)

\* cited by examiner

(\*\*) Term: **14 Years**

*Primary Examiner*—Raphael Barkai  
(74) *Attorney, Agent, or Firm*—Dennison, Schultz &  
Dougherty

(21) Appl. No.: **29/150,668**

(57) **CLAIM**

(22) Filed: **Nov. 28, 2001**

The ornamental design for the skate base, as shown and described.

(51) **LOC (7) Cl.** ..... **21-02**

(52) **U.S. Cl.** ..... **D21/763**

(58) **Field of Search** ..... D21/760, 763-765,  
D21/771; 280/11.19, 11.204, 11.207, 11.208,  
11.209, 11.221, 11.233, 11.27, 11.28

**DESCRIPTION**

(56) **References Cited**

**U.S. PATENT DOCUMENTS**

3,968,973	A	*	7/1976	McCormack	.....	280/11.209
4,345,774	A	*	8/1982	Poe	.....	280/11.209
D272,258	S	*	1/1984	Olivieri	.....	D21/763
4,657,265	A	*	4/1987	Ruth	.....	280/11.27
D299,260	S	*	1/1989	Vullierme	.....	D21/763
D387,832	S	*	12/1997	Lee	.....	D21/764

FIG. 1 is a perspective view of the skate base showing the new design;  
FIG. 2 is a front view of the new design;  
FIG. 3 is a rear view of the new design;  
FIG. 4 is a left view of the new design;  
FIG. 5 is a right view of the new design;  
FIG. 6 is a top view of the new design;  
FIG. 7 is a bottom view of the new design; and,  
FIG. 8 is another perspective view showing the design.

**1 Claim, 8 Drawing Sheets**

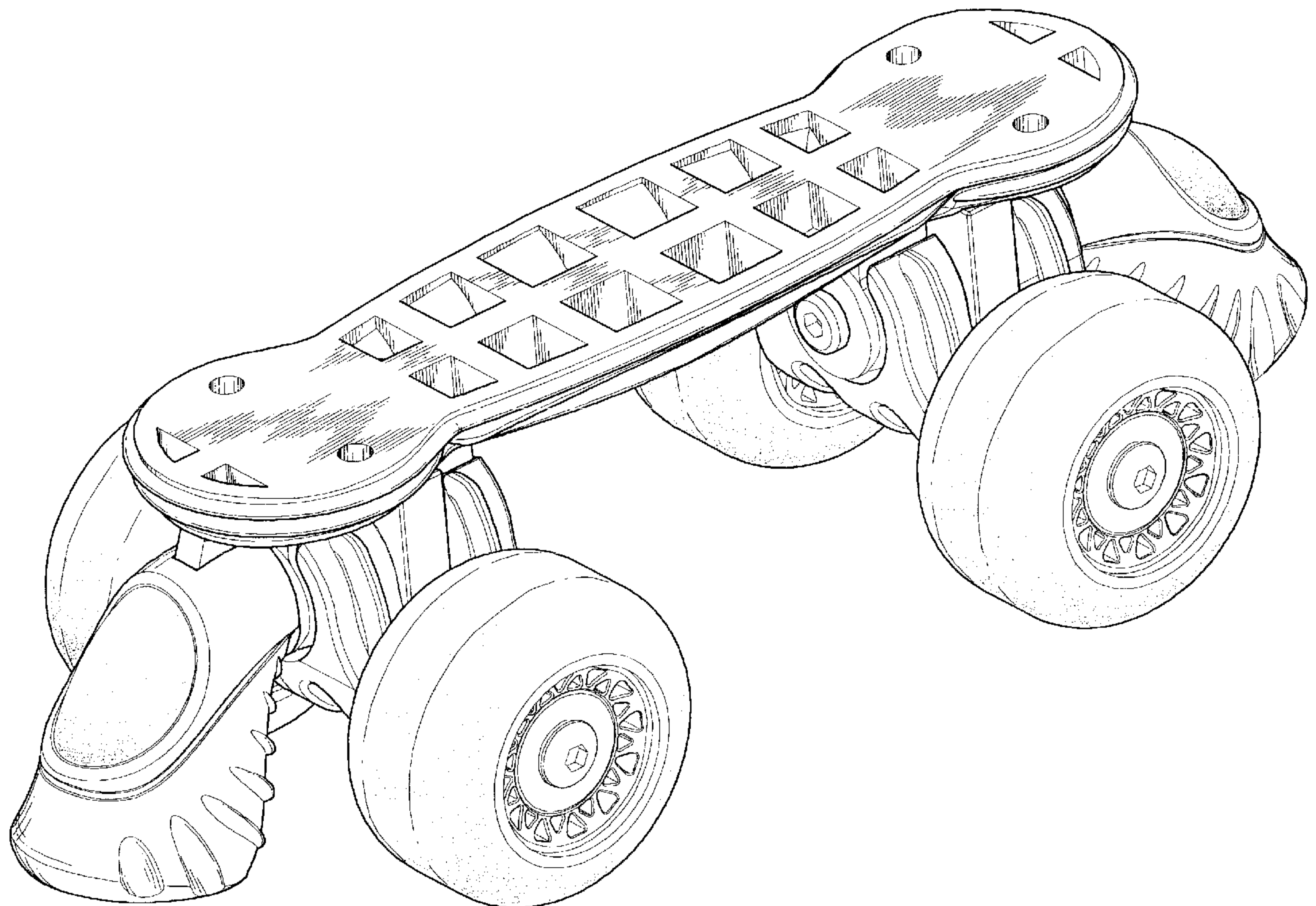

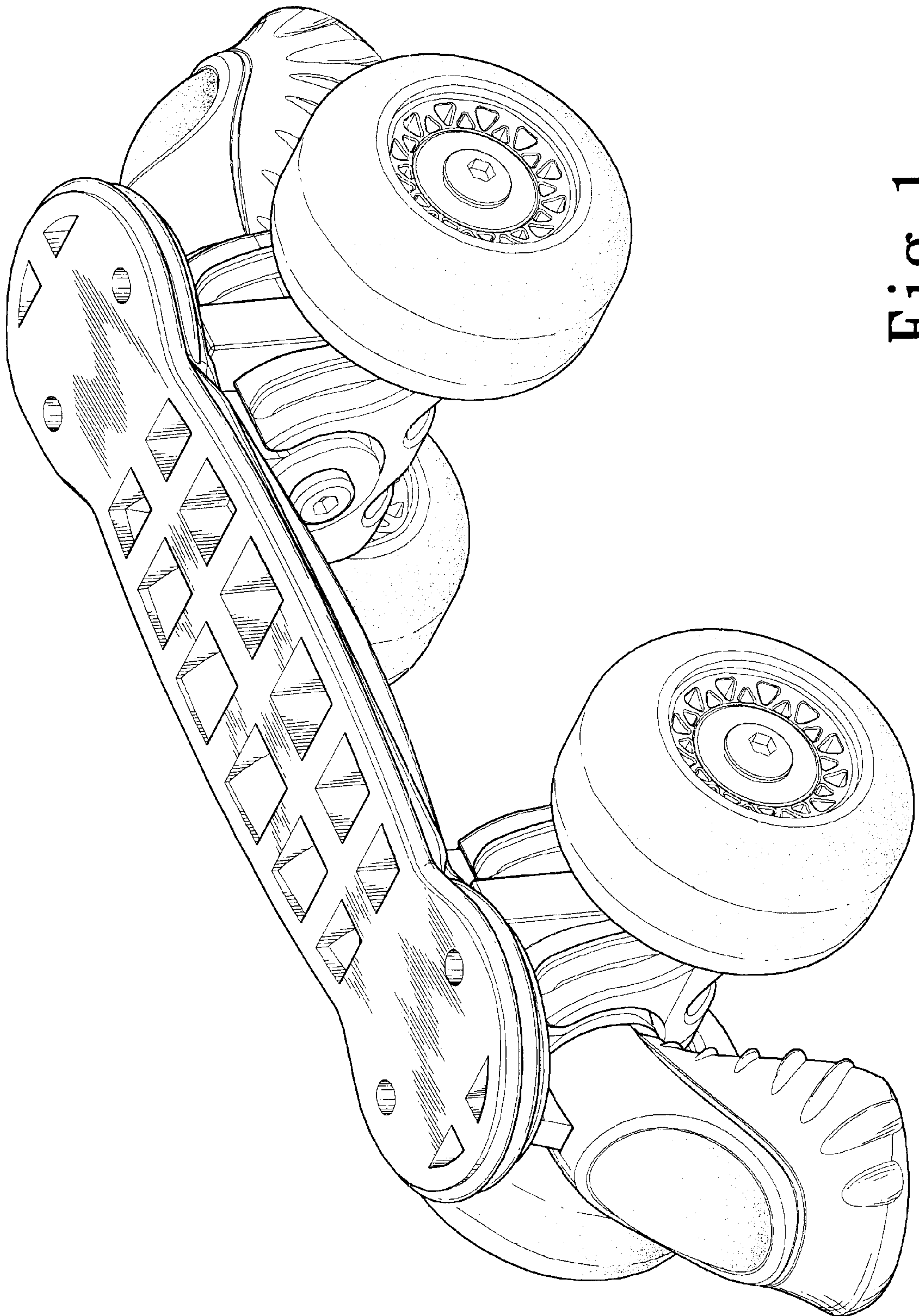

Fig. 1



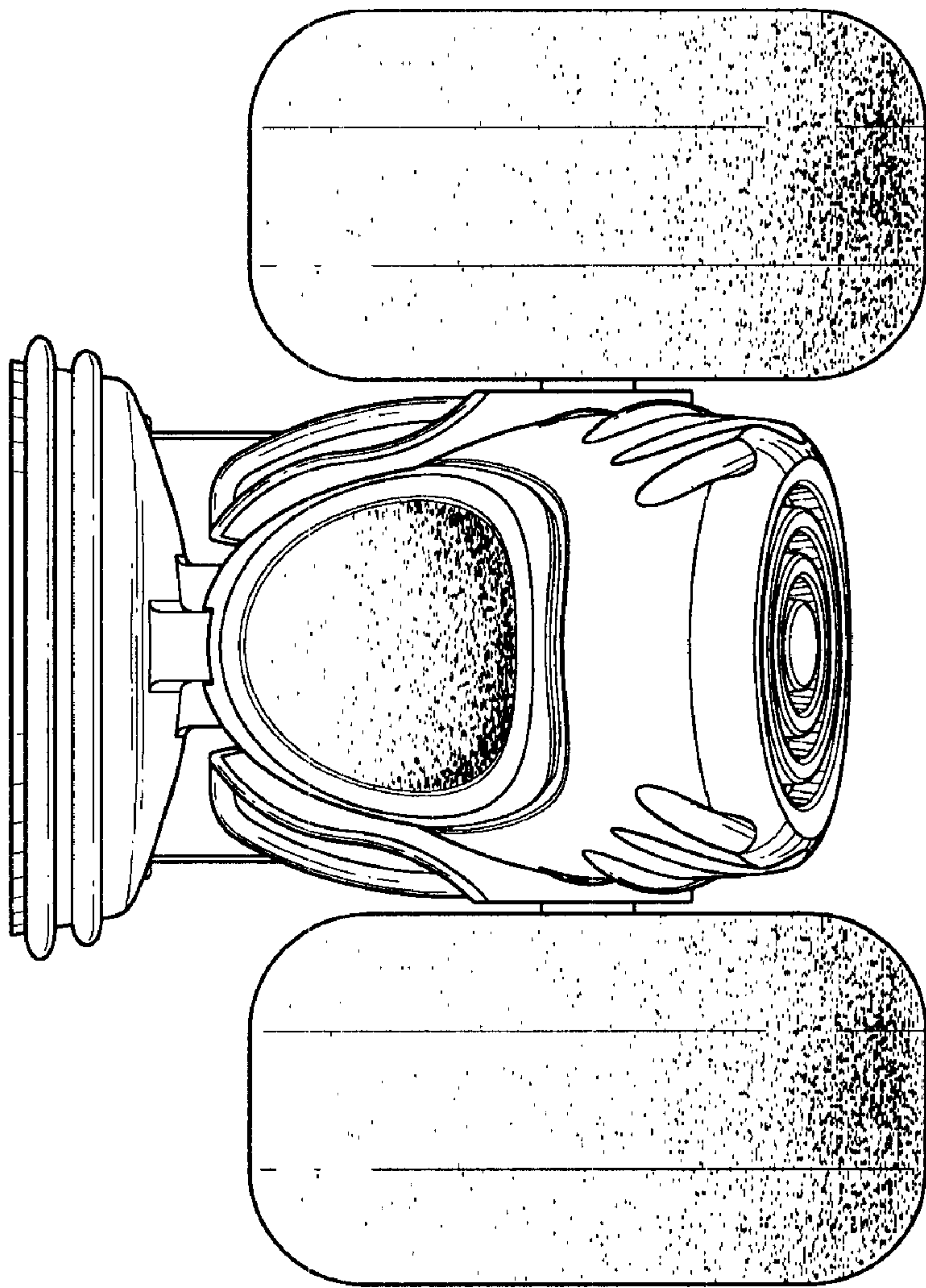

Fig. 2

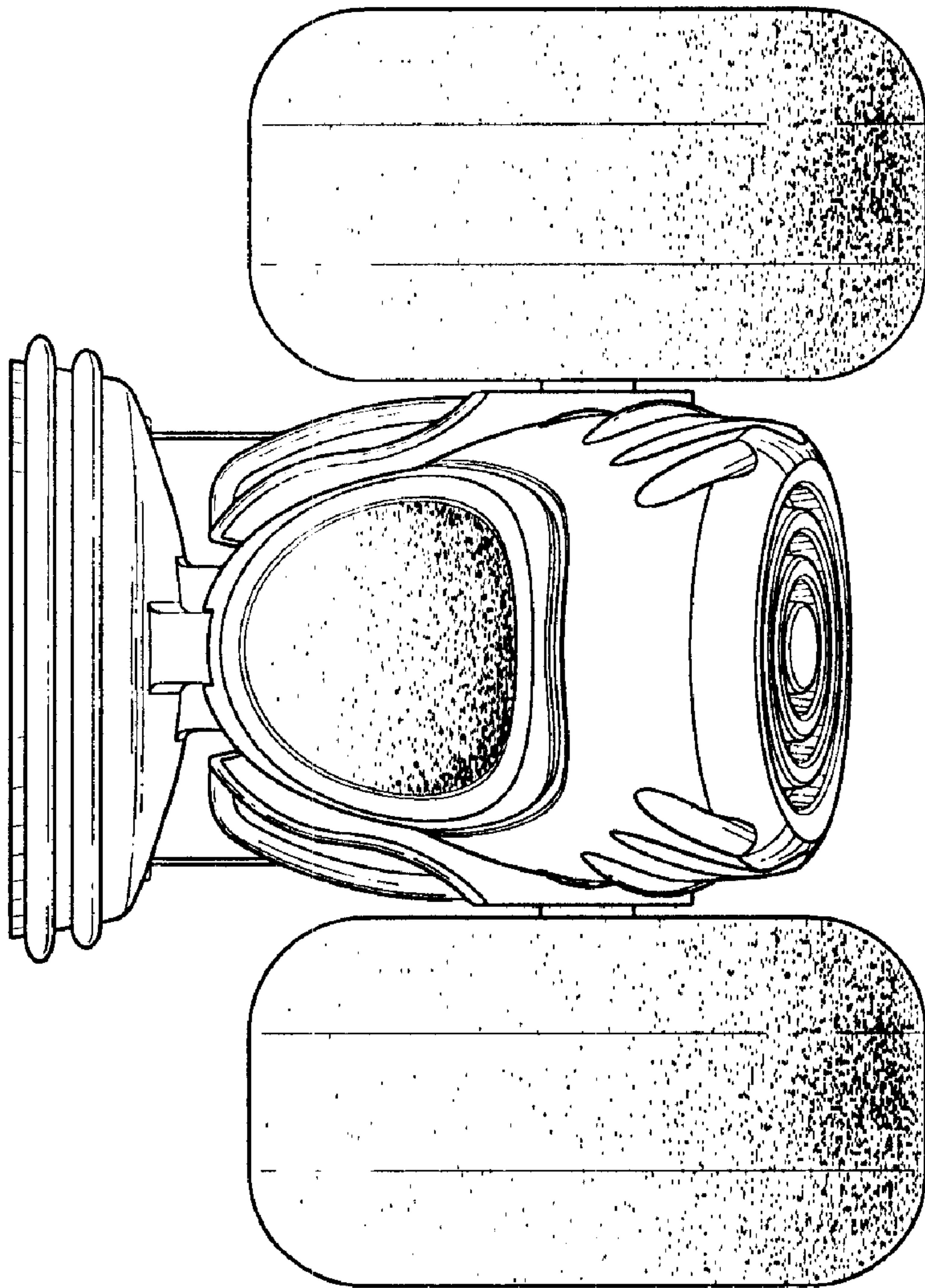

Fig. 3

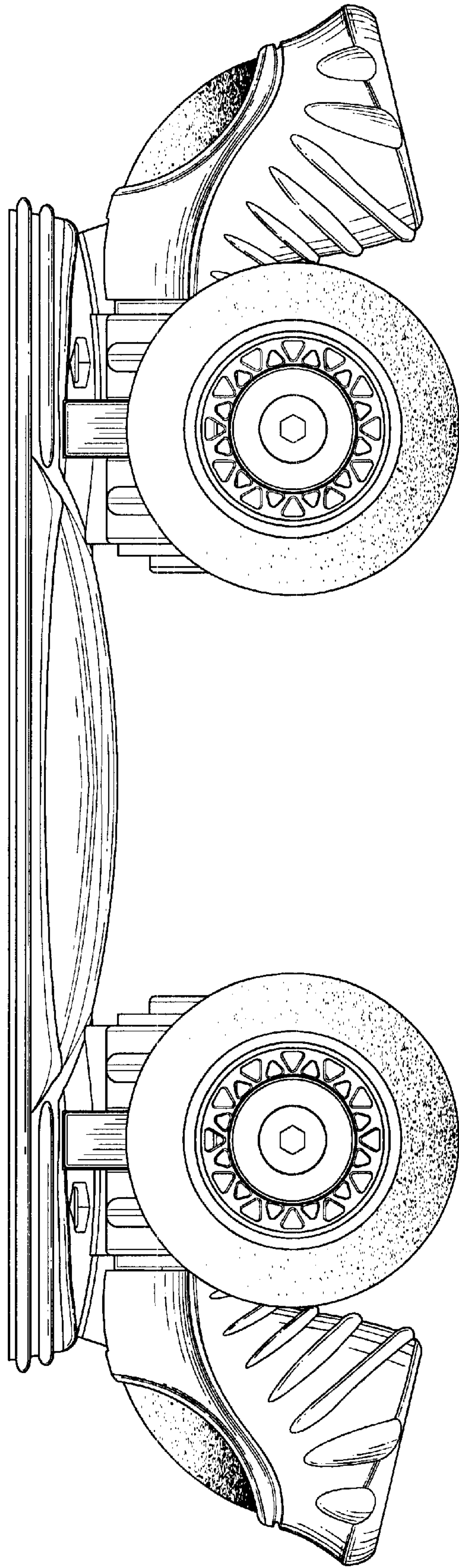

Fig. 4

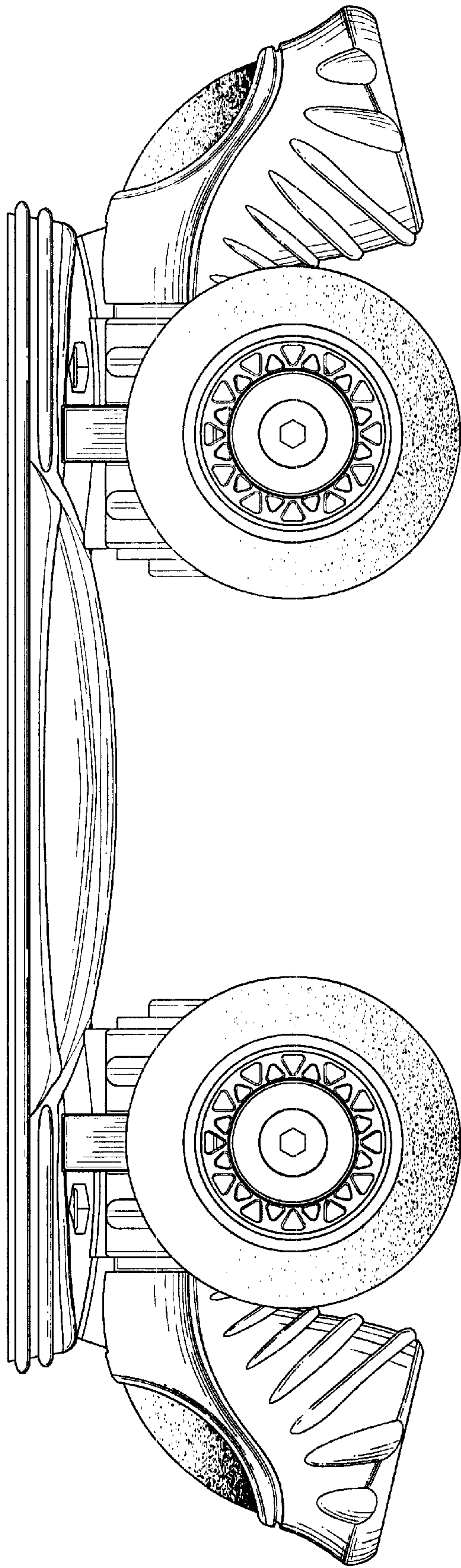

Fig. 5



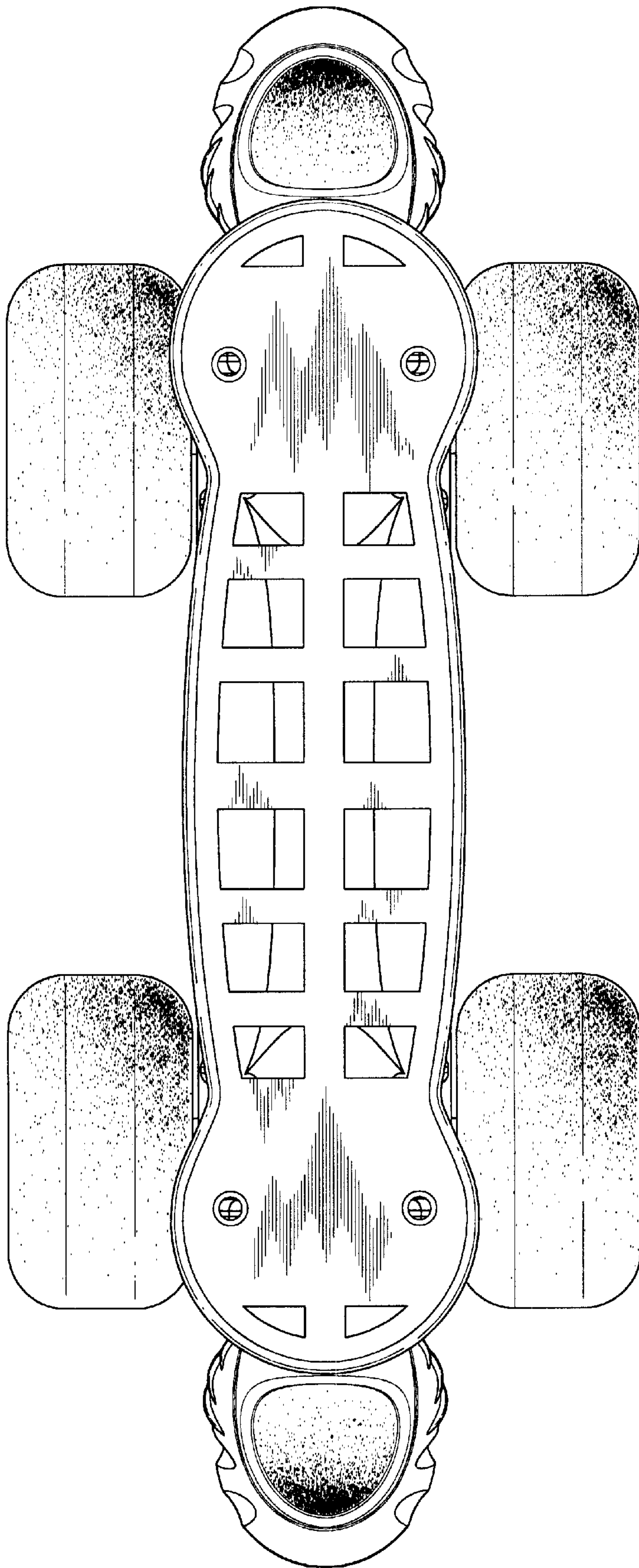

Fig. 6

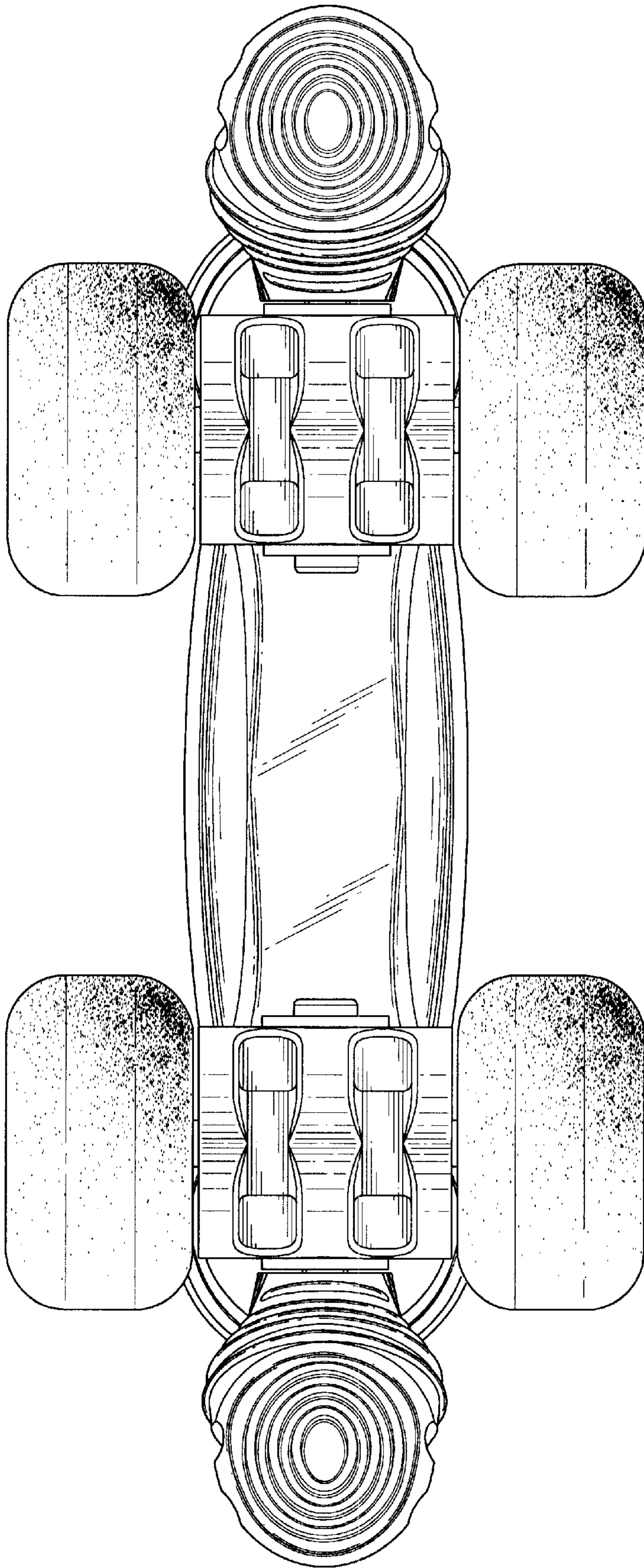

Fig. 7



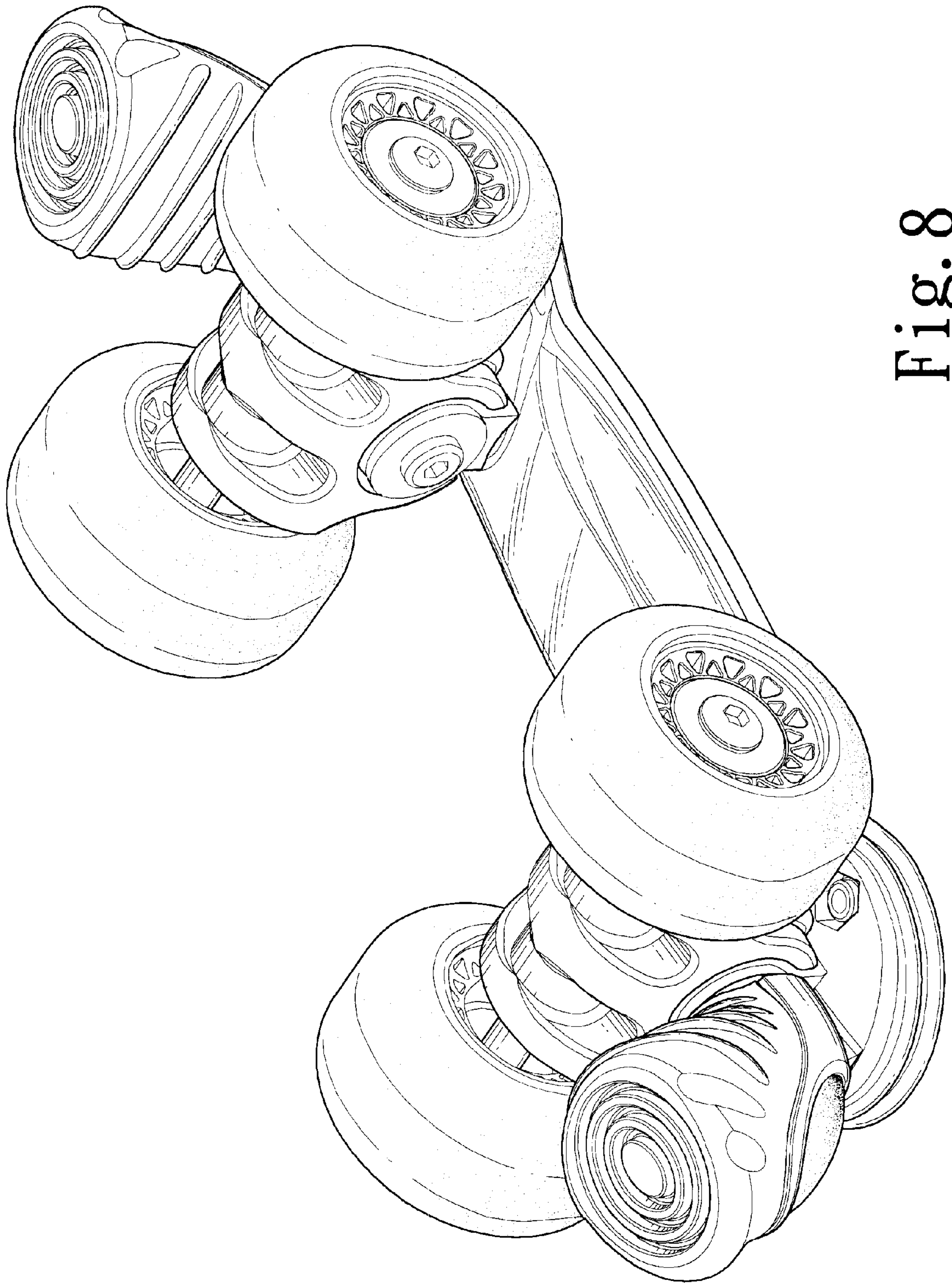

Fig. 8