



US00D464694S

(12) **United States Design Patent**
Moore

(10) **Patent No.:** **US D464,694 S**

(45) **Date of Patent:** **** Oct. 22, 2002**

(54) **PUTTER GRIP**

(74) *Attorney, Agent, or Firm*—McNair Law Firm, P.A.

(76) **Inventor:** **Tad Moore**, 724 Ridge Crest Rd.,
LaGrange, GA (US) 30240

(57) **CLAIM**

The ornamental design for a putter grip, as shown and described.

(**) **Term:** **14 Years**

DESCRIPTION

(21) **Appl. No.:** **29/153,877**

FIG. 1 is a front elevational view of the putter grip showing my new design, the broken line showing is for illustrative purposes only and forms no part of the claimed design;

(22) **Filed:** **Oct. 22, 2001**

FIG. 2 is a front elevational view;

(51) **LOC (7) Cl.** **21-02**

(52) **U.S. Cl.** **D21/756**

FIG. 3 is an enlarged cross sectional view taken on line 3—3 of FIG. 2;

(58) **Field of Search** D21/756, 757;
473/300—303, 316—323

FIG. 4 is an enlarged cross sectional view taken on line 4—4 of FIG. 2;

(56) **References Cited**

U.S. PATENT DOCUMENTS

D196,268 S * 9/1963 Lamb D21/756

5,575,473 A * 11/1996 Turner 473/303

5,779,559 A * 7/1998 Eberle 473/303

FIG. 5 is an enlarged top plan view of FIG. 2;

FIG. 6 is a fragmented upper portion of FIG. 2;

FIG. 7 is a fragmented lower portion of FIG. 2;

FIG. 8 is a cross sectional view taken on line 8—8 of FIG. 6; and,

FIG. 9 is a cross sectional view taken on line 9—9 of FIG. 7.

* cited by examiner

Primary Examiner—Mitchell Siegel

1 Claim, 3 Drawing Sheets

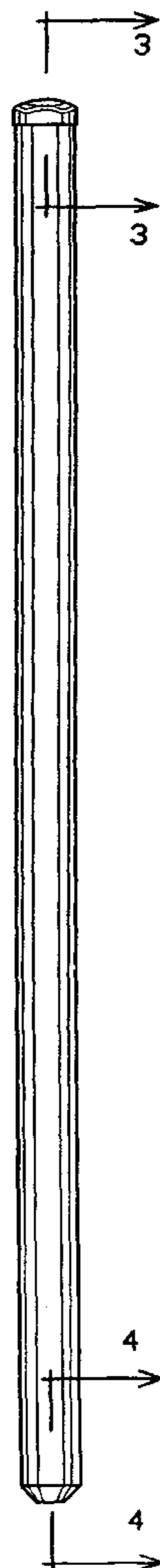

Fig. 1

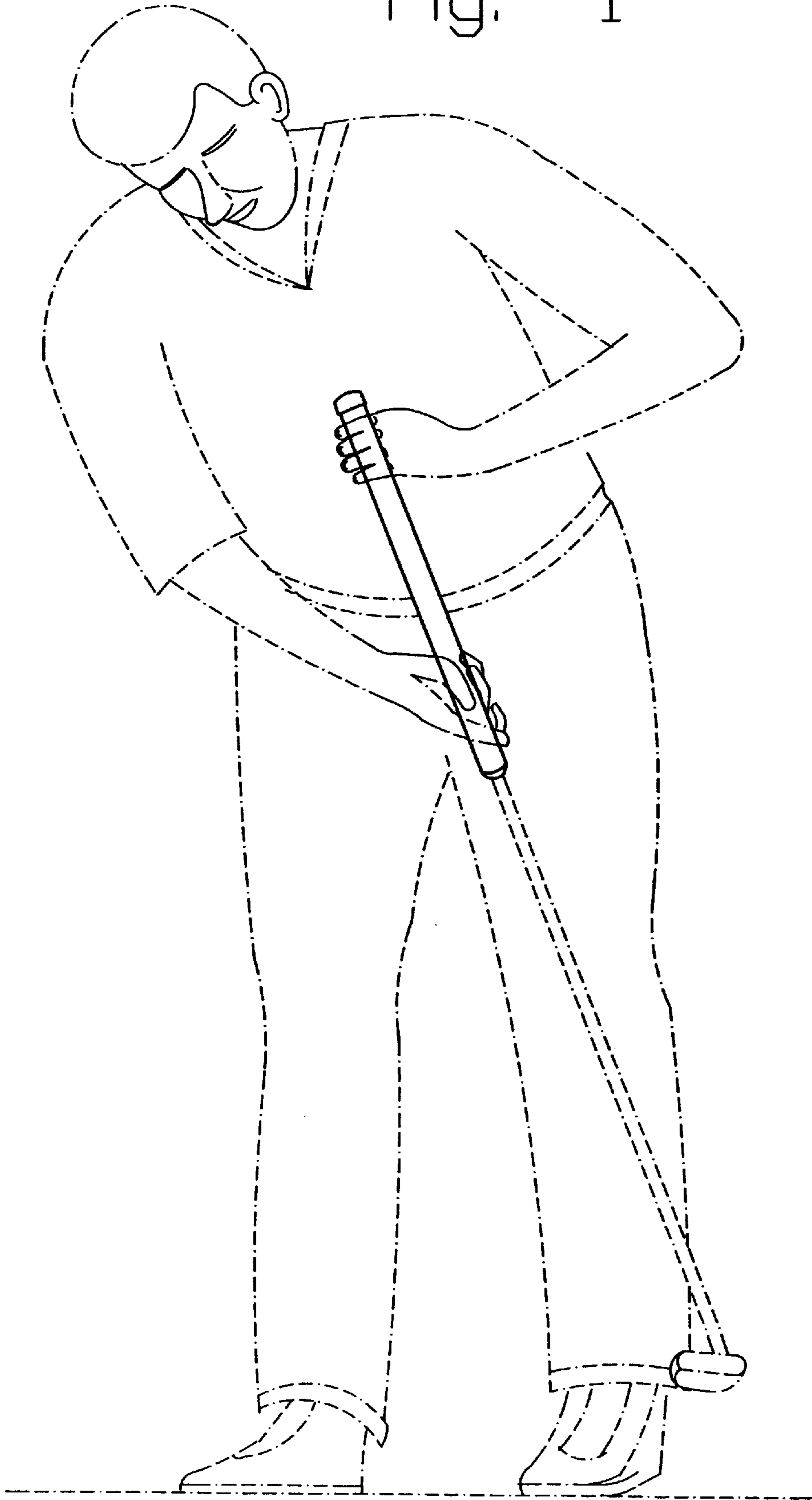

Fig. 2

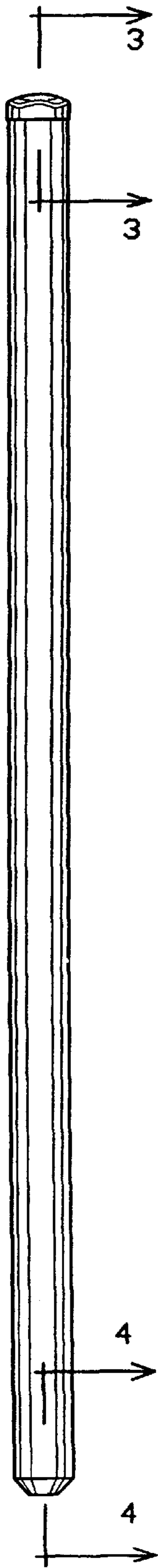

Fig. 3

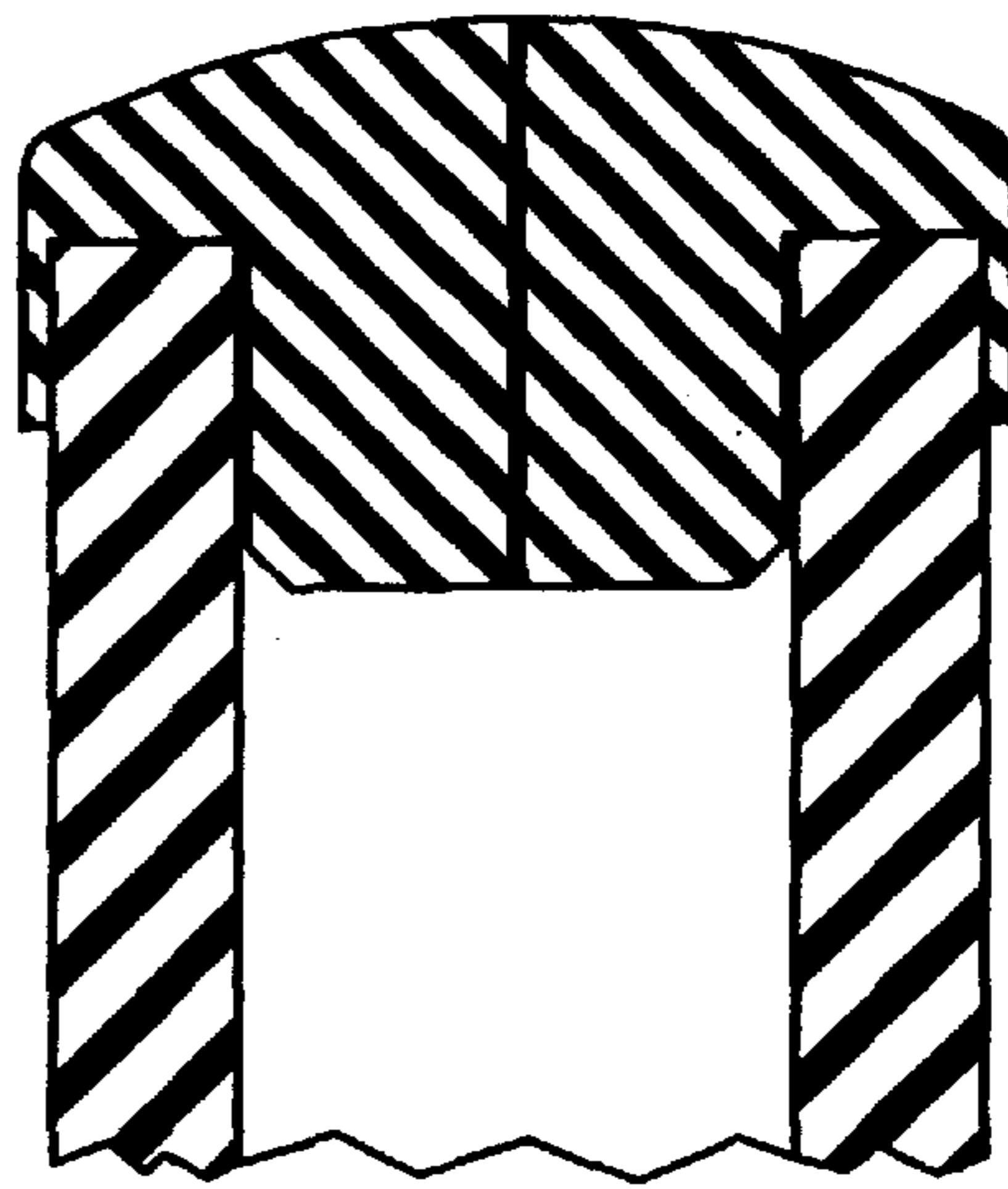

Fig. 4

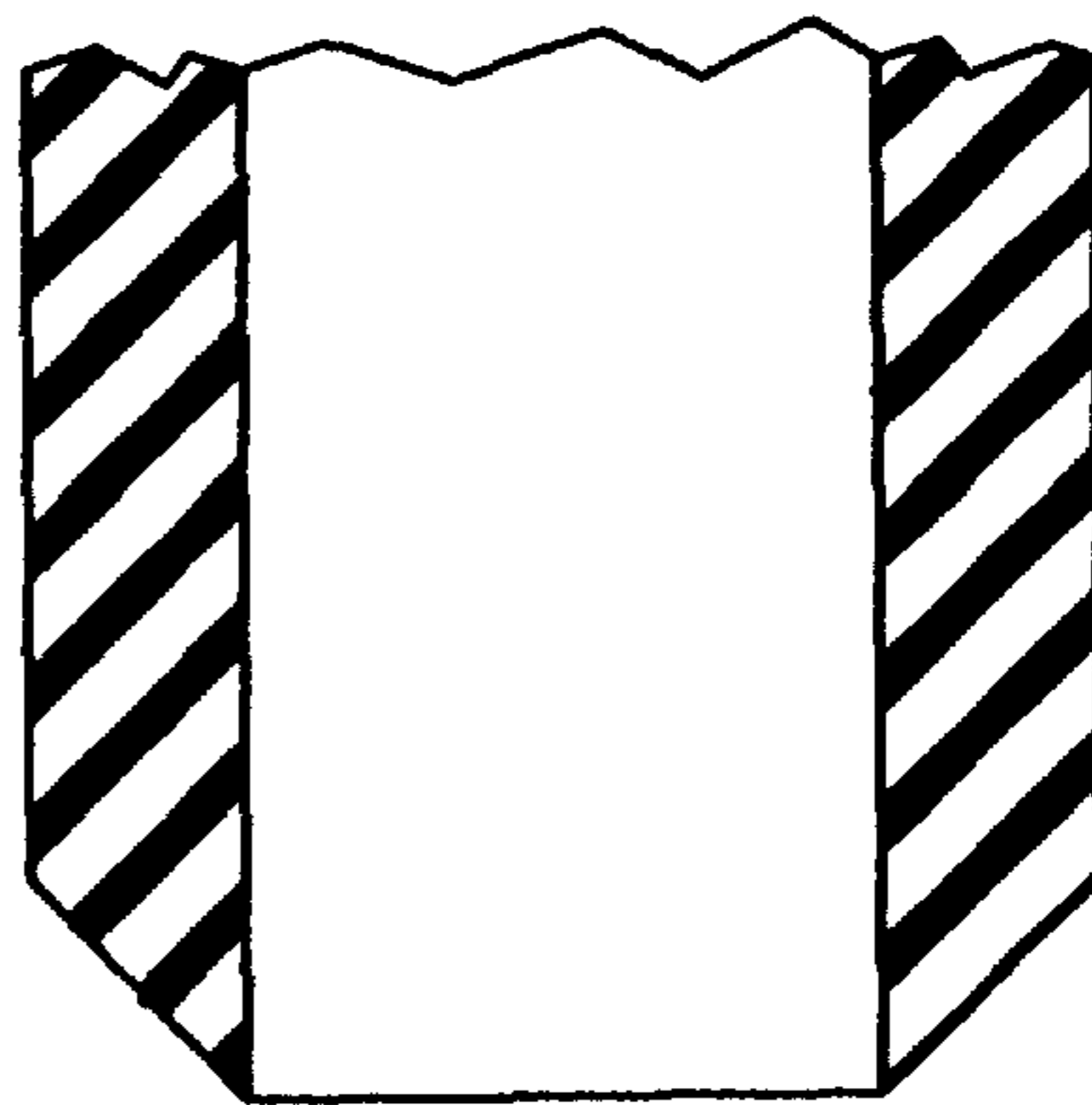

Fig. 5

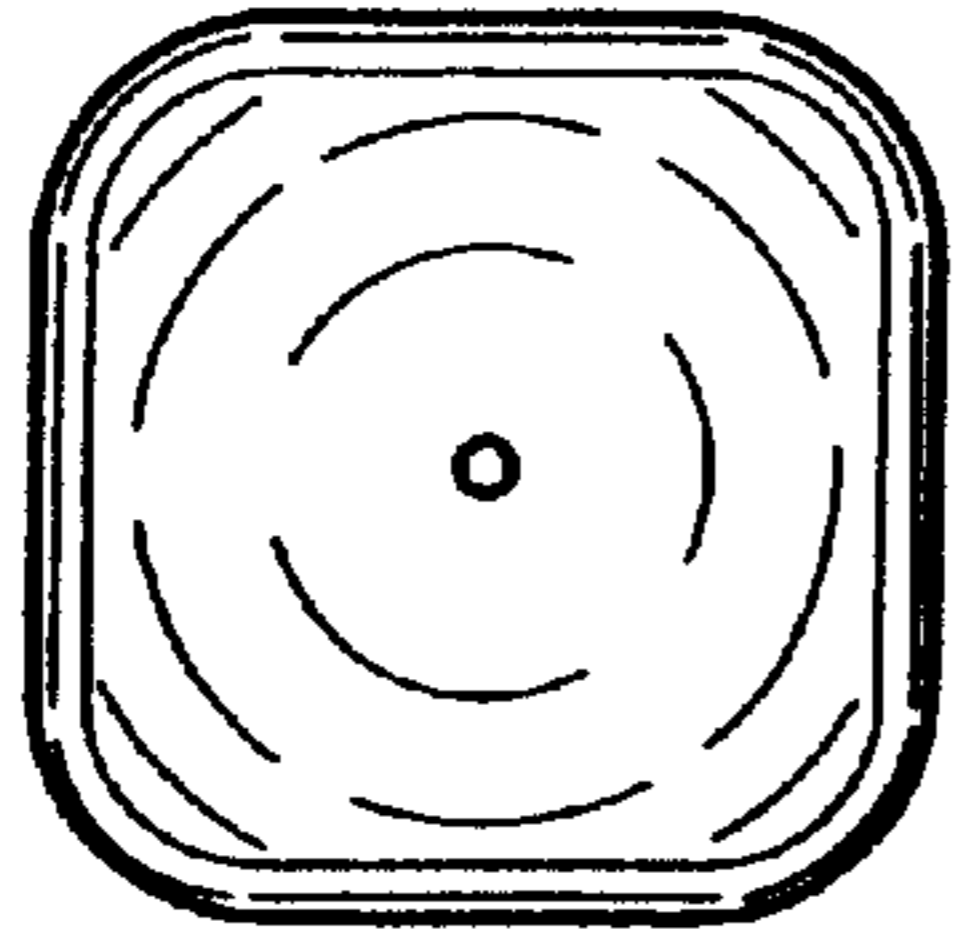

Fig. 8

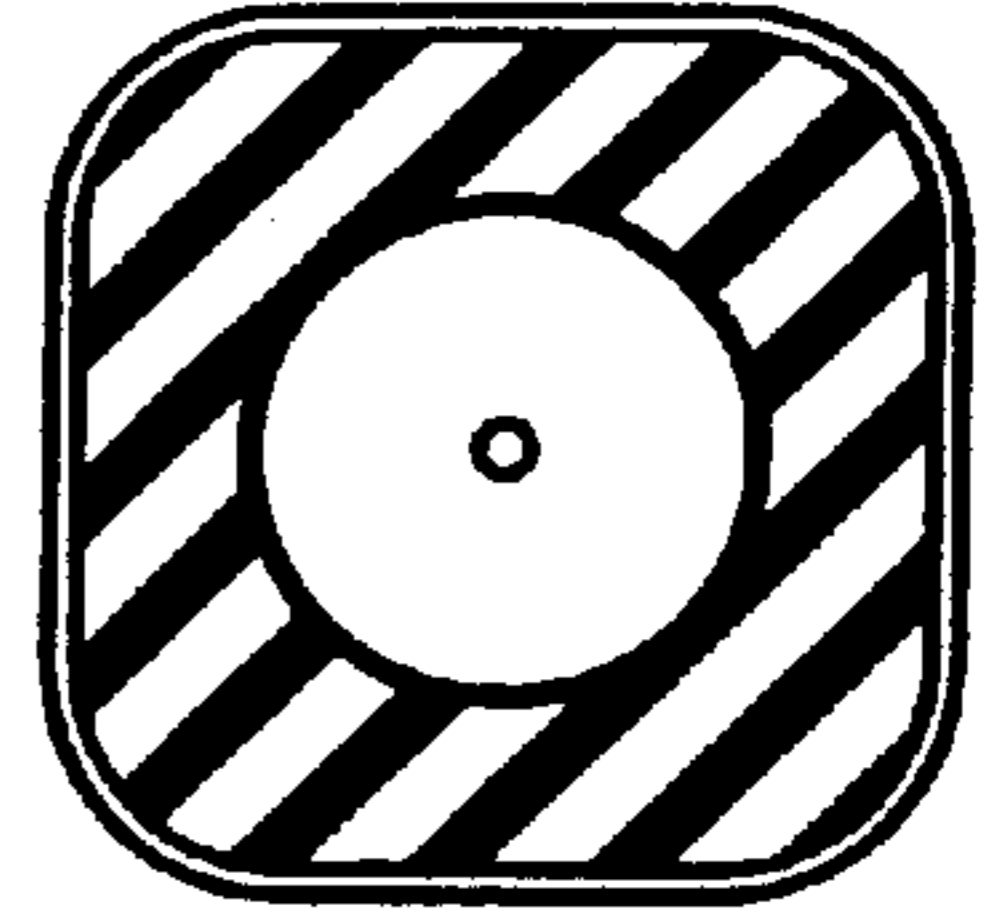

Fig. 6

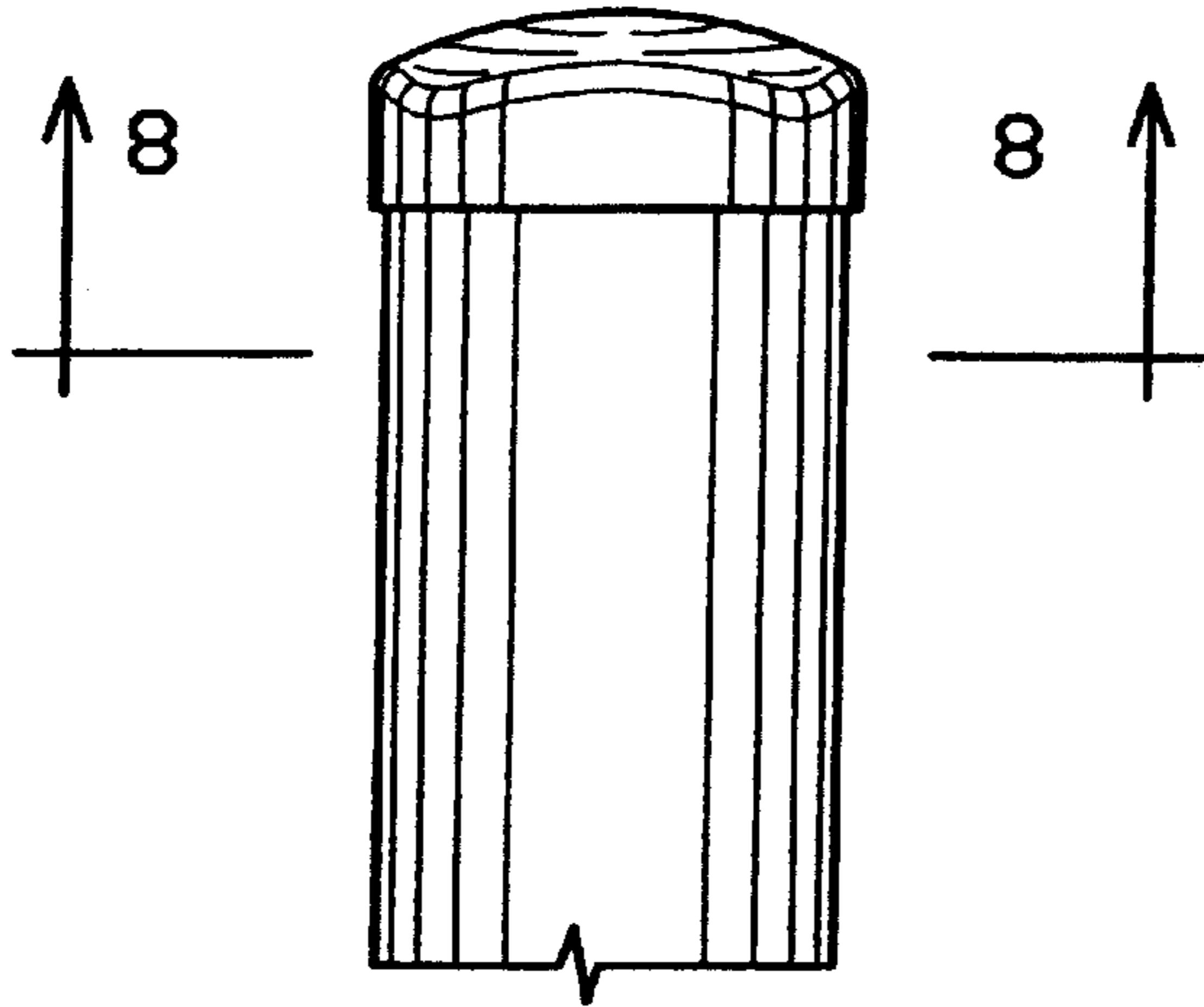

Fig. 9

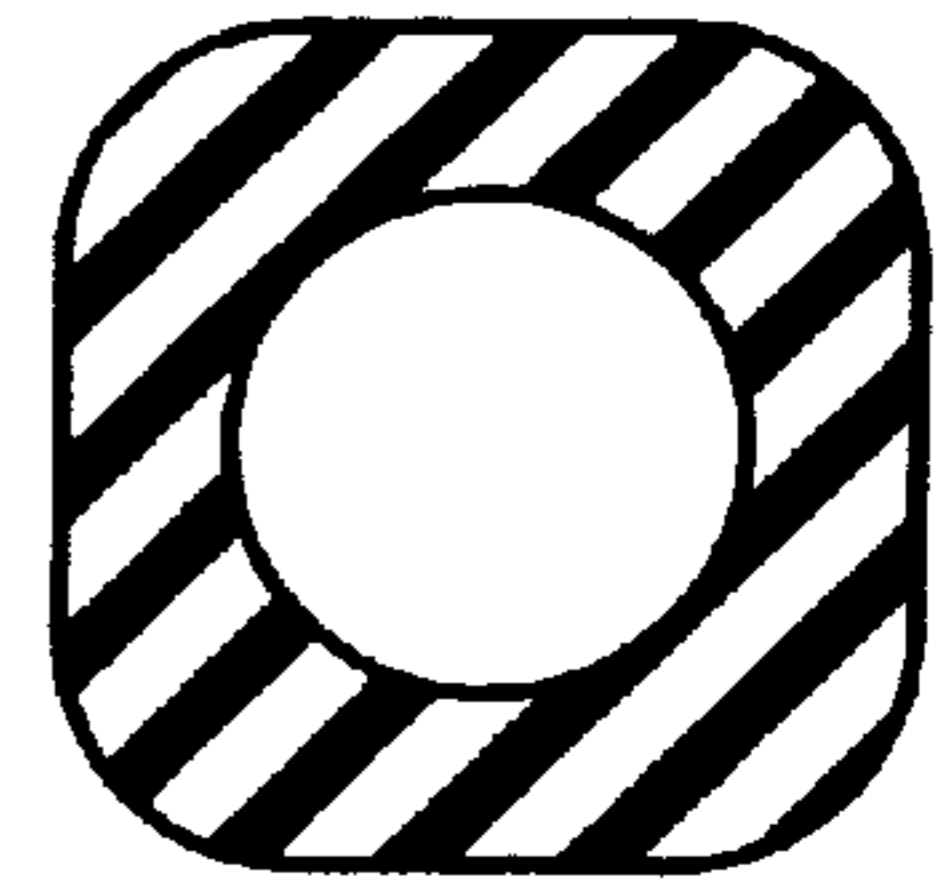

Fig. 7

