



US00D464581S

(12) **United States Design Patent**  
**Montagnino et al.**

(10) **Patent No.:** **US D464,581 S**

(45) **Date of Patent:** **\*\* Oct. 22, 2002**

(54) **PLATFORM SCALE**

D377,617 S \* 1/1997 Gerstner et al. .... D10/92

(75) Inventors: **James G. Montagnino**, St. Charles, IL (US); **Anson Wong**, Boca Raton, FL (US); **Christian Kulujian**, Chicago, IL (US); **Curtis L. Cruver, IV**, Elmhurst, IL (US)

\* cited by examiner

*Primary Examiner*—Antoine Duval Davis  
(74) *Attorney, Agent, or Firm*—Lawrence J. Shurupoff

(73) Assignee: **Sunbeam Products, Inc.**, Boca Raton, FL (US)

(57) **CLAIM**

The ornamental design for a platform scale, as shown and described.

(\*\*) Term: **14 Years**

**DESCRIPTION**

(21) Appl. No.: **29/156,140**

FIG. 1 is a top left perspective view of the platform scale showing the new design;

(22) Filed: **Feb. 20, 2002**

FIG. 2 is a top plan view thereof;

(51) **LOC (7) Cl.** ..... **10-04**

FIG. 3 is a left side elevational view thereof and being substantially the same as the right side elevational view thereof;

(52) **U.S. Cl.** ..... **D10/92**

(58) **Field of Search** ..... D10/92; 177/210, 177/211, 238-245

FIG. 4 is a rear elevational view thereof;

FIG. 5 is a front elevational view thereof; and,

FIG. 6 is a bottom plan view thereof.

(56) **References Cited**

**U.S. PATENT DOCUMENTS**

D317,578 S \* 6/1991 Joss et al. .... D10/92

**1 Claim, 2 Drawing Sheets**

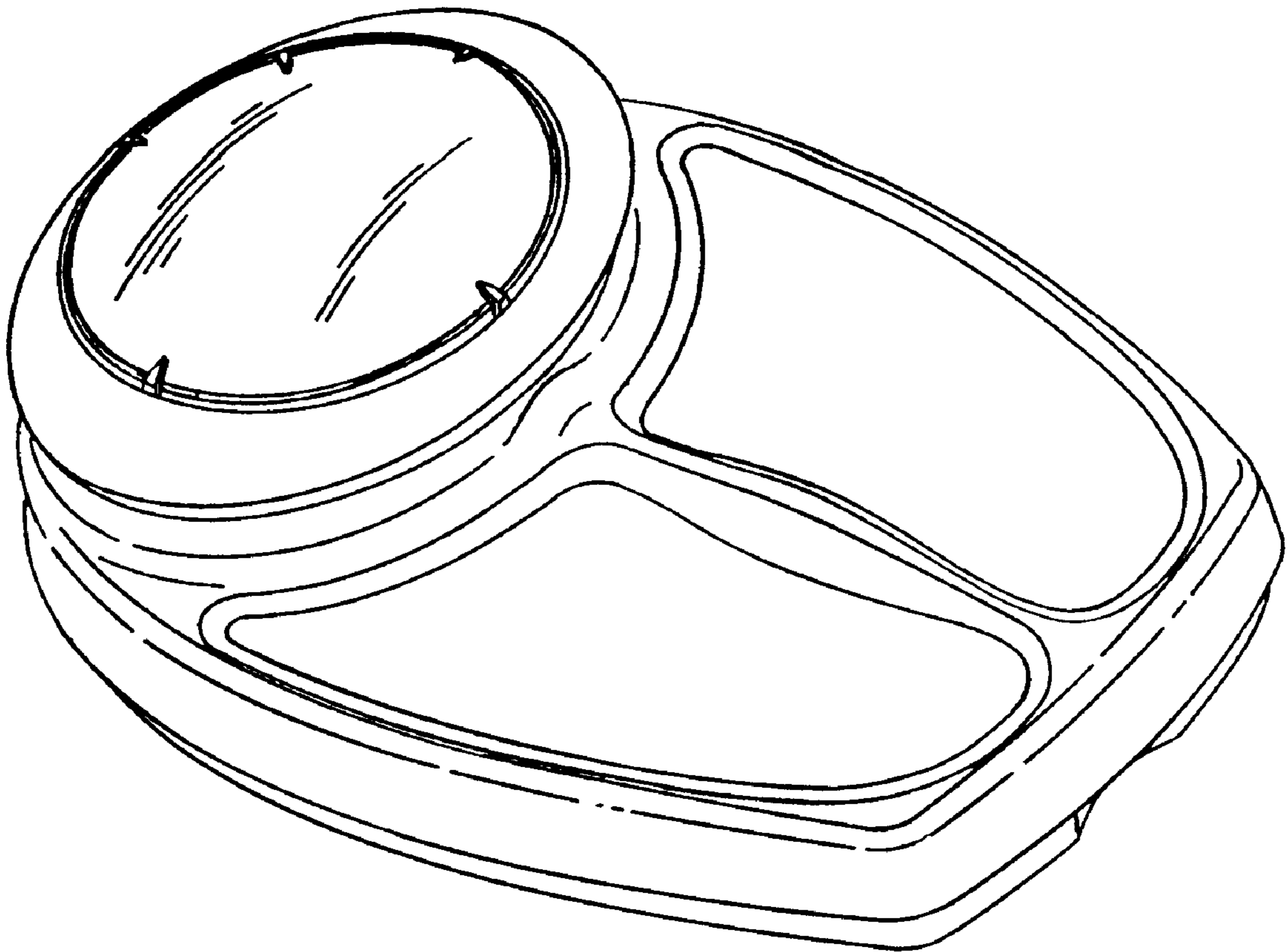

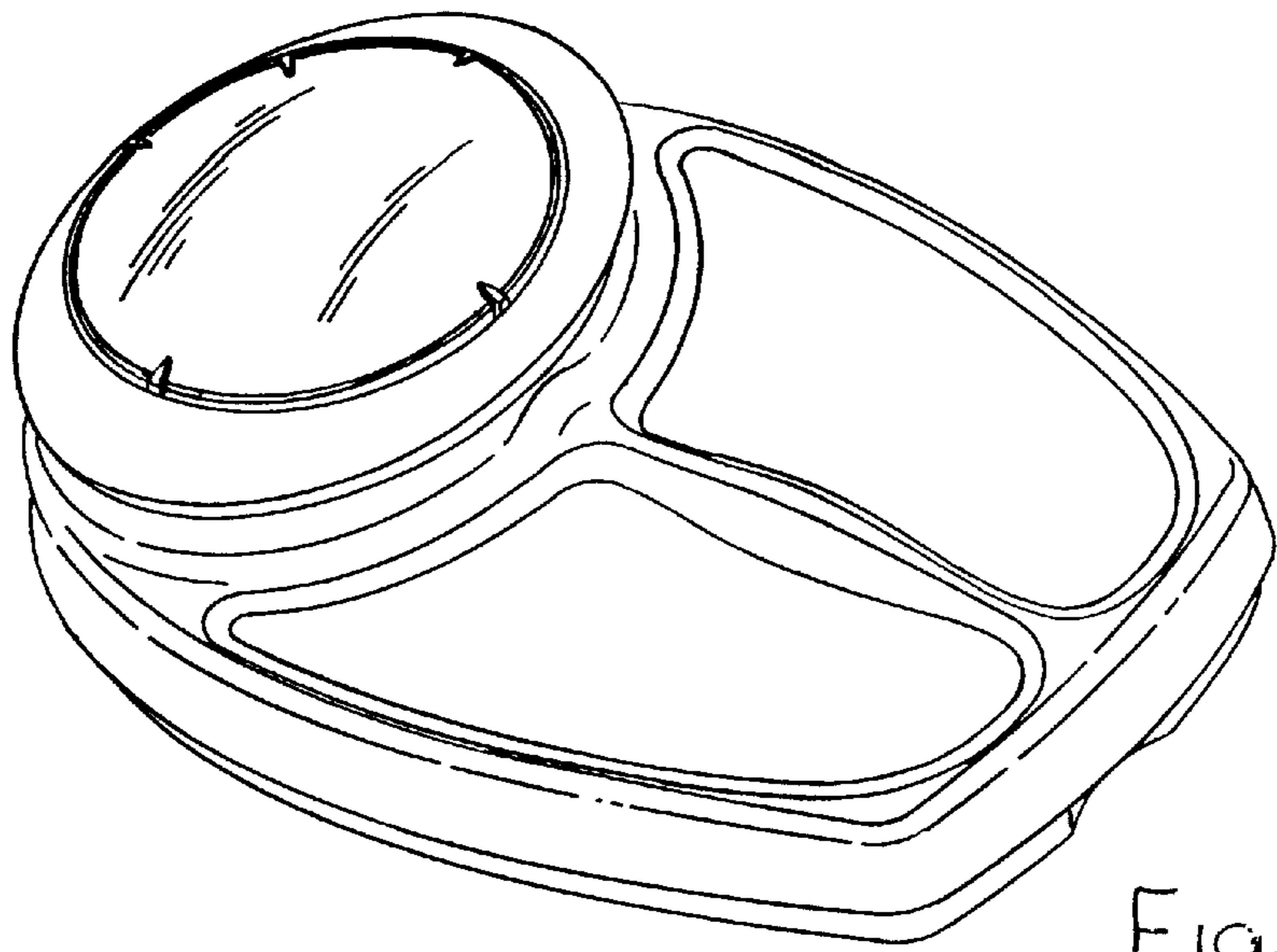

Fig. 1

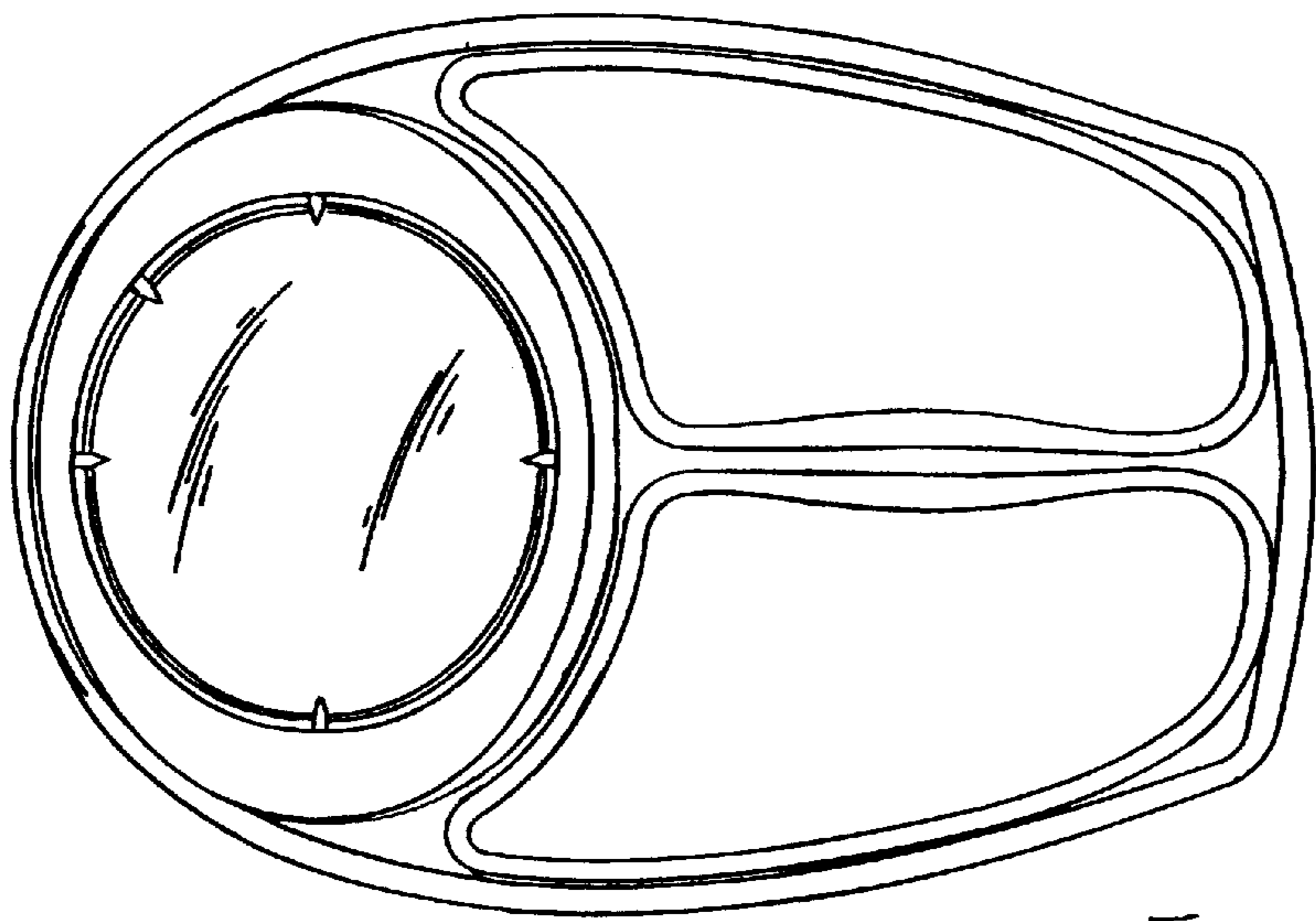

Fig. 2

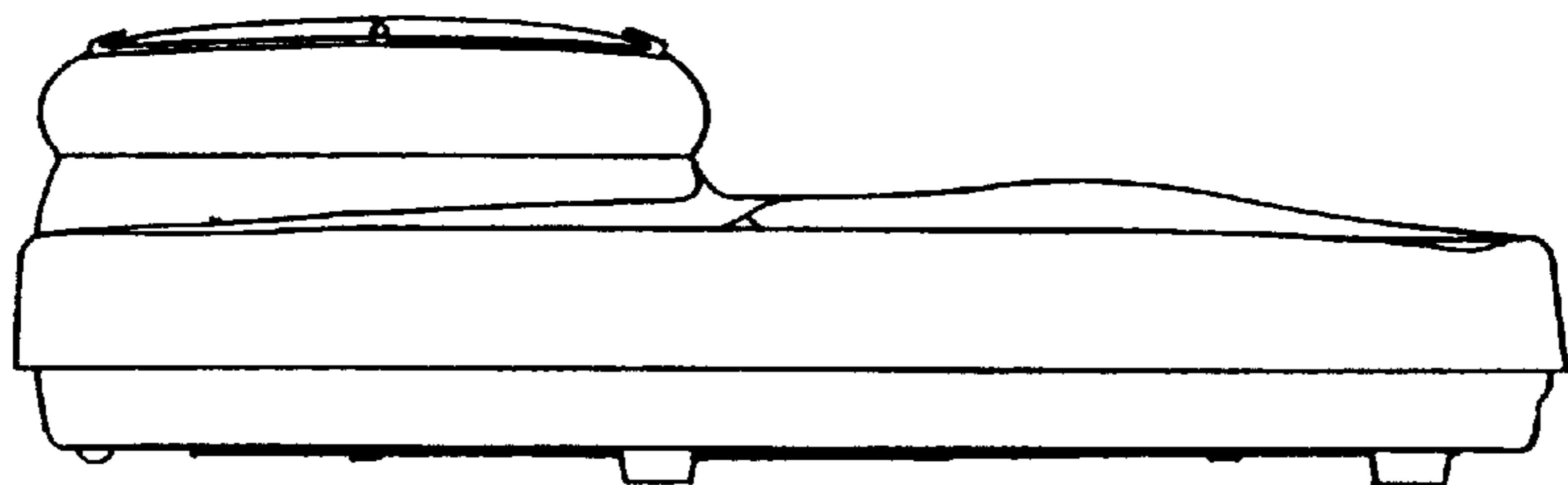

Fig. 3

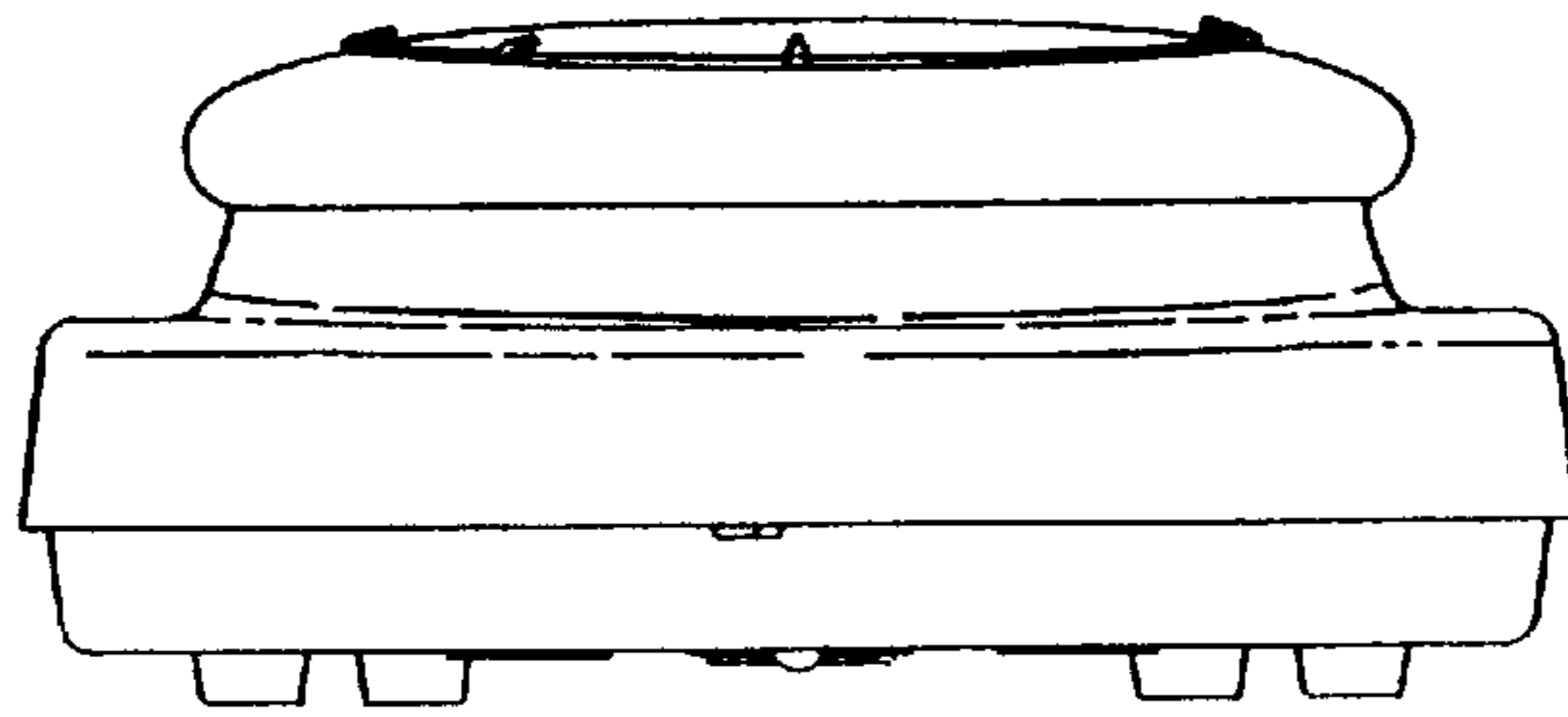

Fig. 4

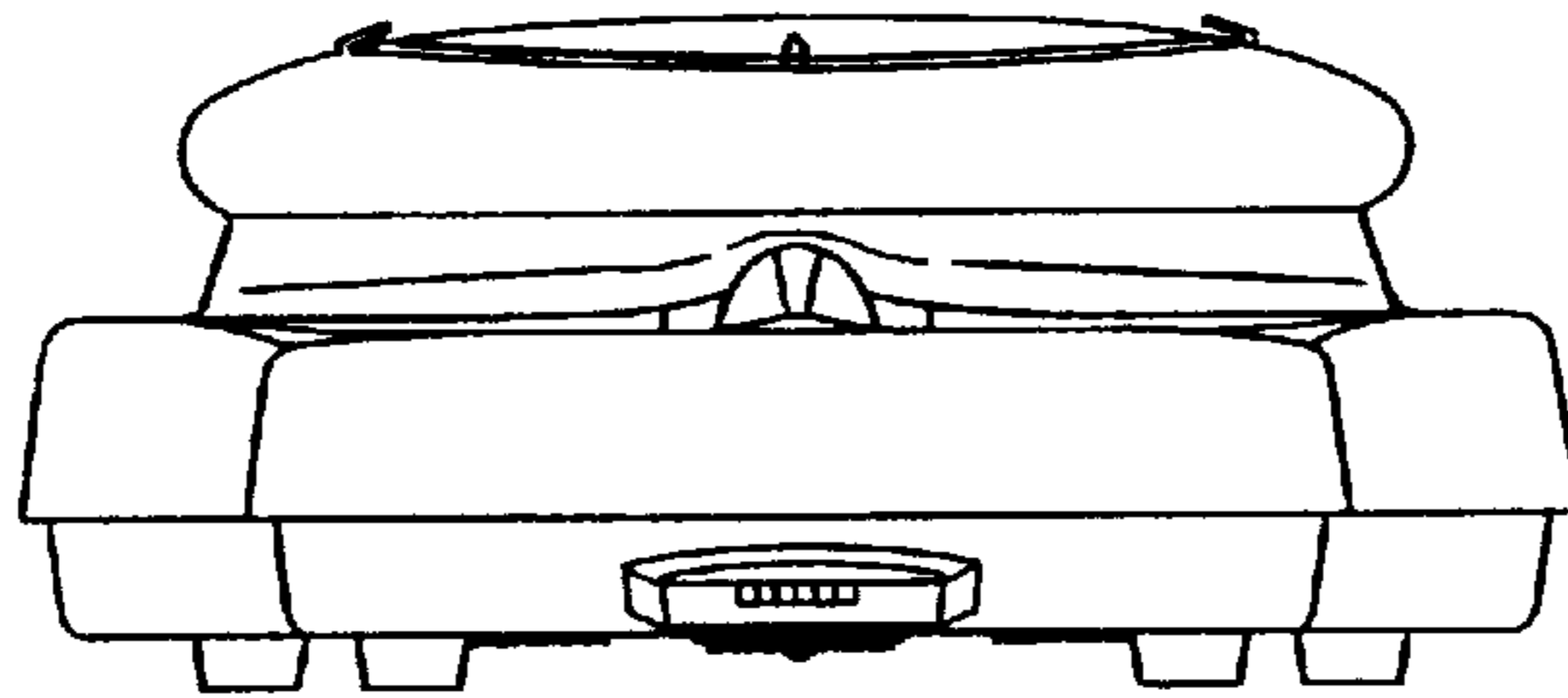

Fig. 5

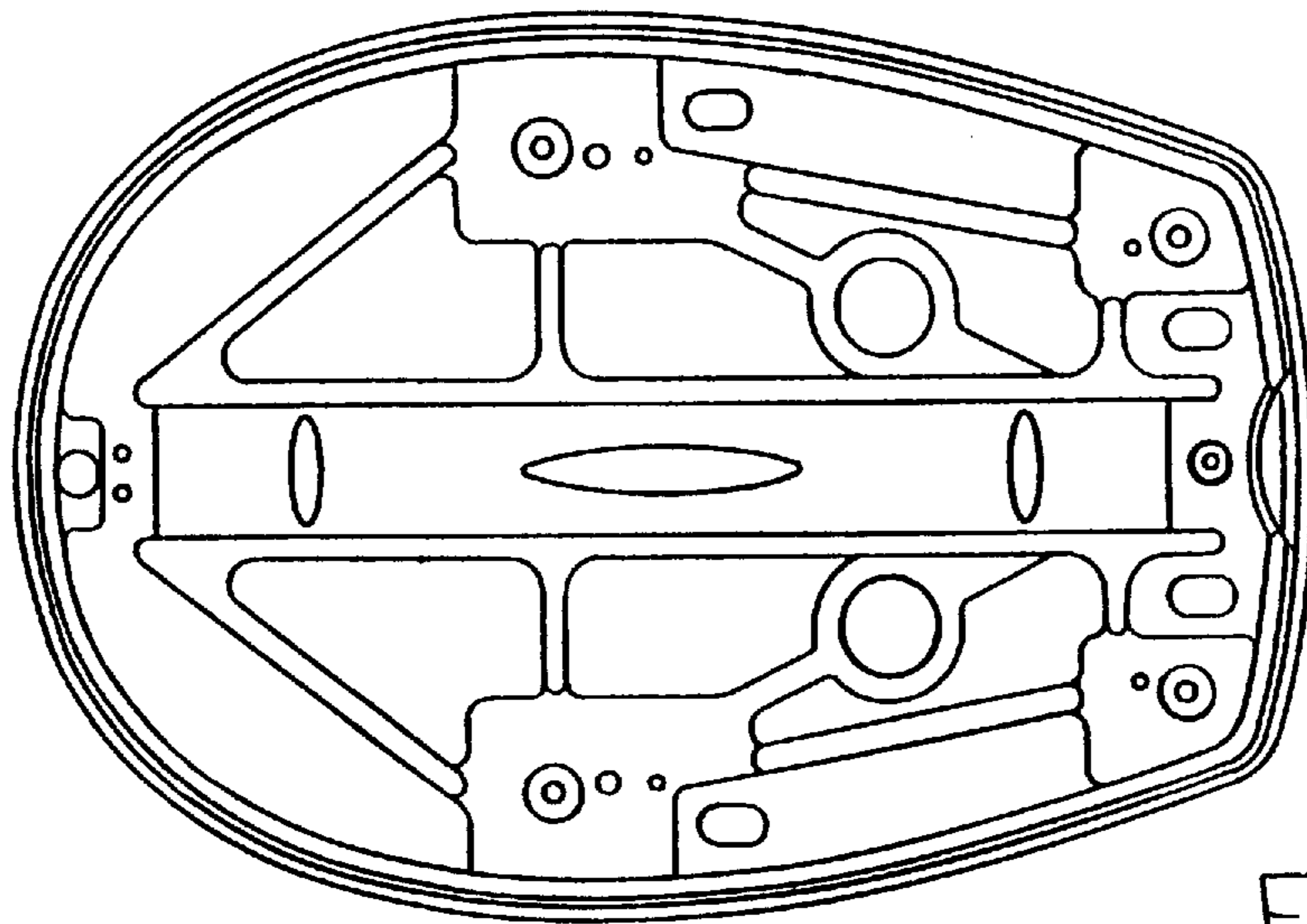

Fig. 6