



US00D464453S

(12) **United States Design Patent**
Cramer et al.

(10) **Patent No.:** **US D464,453 S**

(45) **Date of Patent:** **** Oct. 15, 2002**

(54) **FOLDING LIGHT**

D431,308 S * 9/2000 Lynch et al. D26/37
D452,020 S * 12/2001 Hong D26/37

(75) Inventors: **Steven M. Cramer**, Park City, KS
(US); **Angela T. Hoed**, Wichita, KS
(US); **Robert G. Martinez**, Akron, OH
(US)

* cited by examiner

Primary Examiner—Marcus A. Jackson
(74) *Attorney, Agent, or Firm*—Leydig, Voit & Mayer, Ltd.

(73) Assignee: **The Coleman Company, Inc.**, Wichita,
KS (US)

(57) **CLAIM**

(**) Term: **14 Years**

The ornamental design for a folding light, as shown and described.

(21) Appl. No.: **29/145,658**

DESCRIPTION

(22) Filed: **Jul. 26, 2001**

FIG. 1 is a top, left, perspective view of a folding light showing our new design;
FIG. 2 is a top view thereof;
FIG. 3 is a left side view thereof;
FIG. 4 is a front view thereof;
FIG. 5 is a right side view thereof;
FIG. 6 is a rear view thereof;
FIG. 7 is a bottom view thereof; and,
FIG. 8 is a top, left perspective view of the folding light, showing the folding light opened.

(51) **LOC (7) Cl.** **26-02**

(52) **U.S. Cl.** **D26/39; D26/37**

(58) **Field of Search** D26/37-50; 362/157,
362/158, 171, 172, 173, 181-208

(56) **References Cited**

U.S. PATENT DOCUMENTS

D415,585 S * 10/1999 Leung D26/37

1 Claim, 3 Drawing Sheets

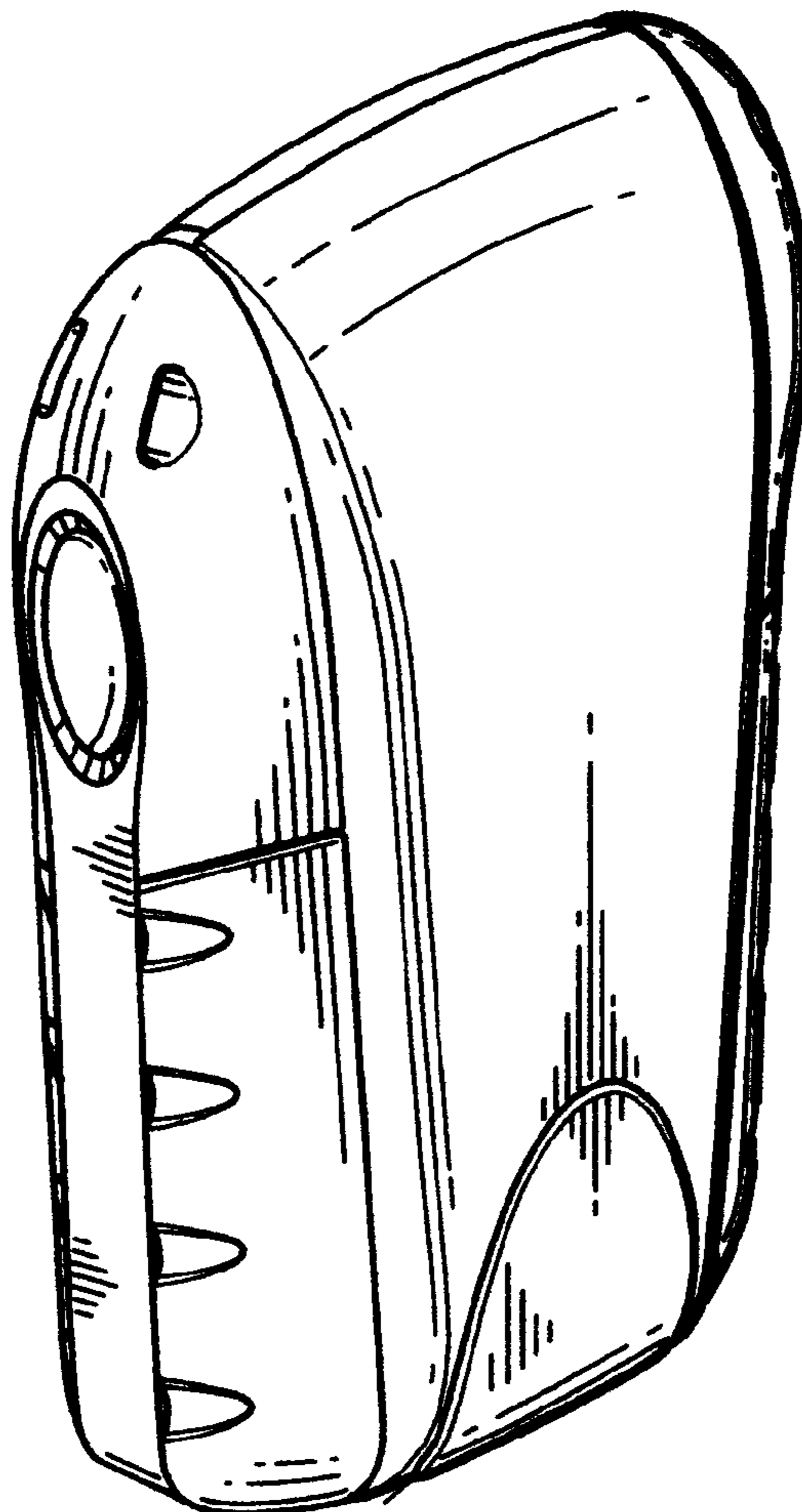

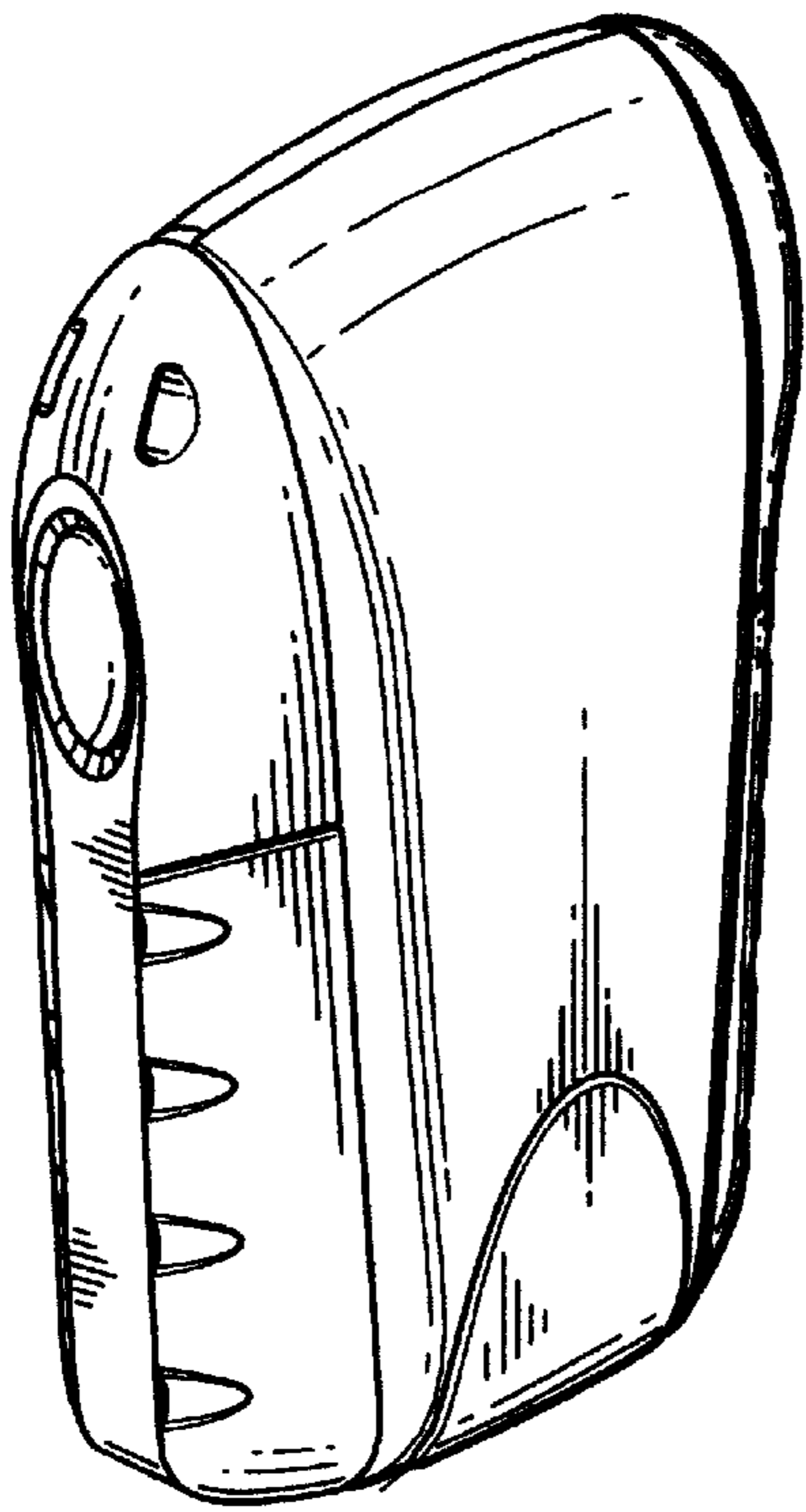

Fig. 1.

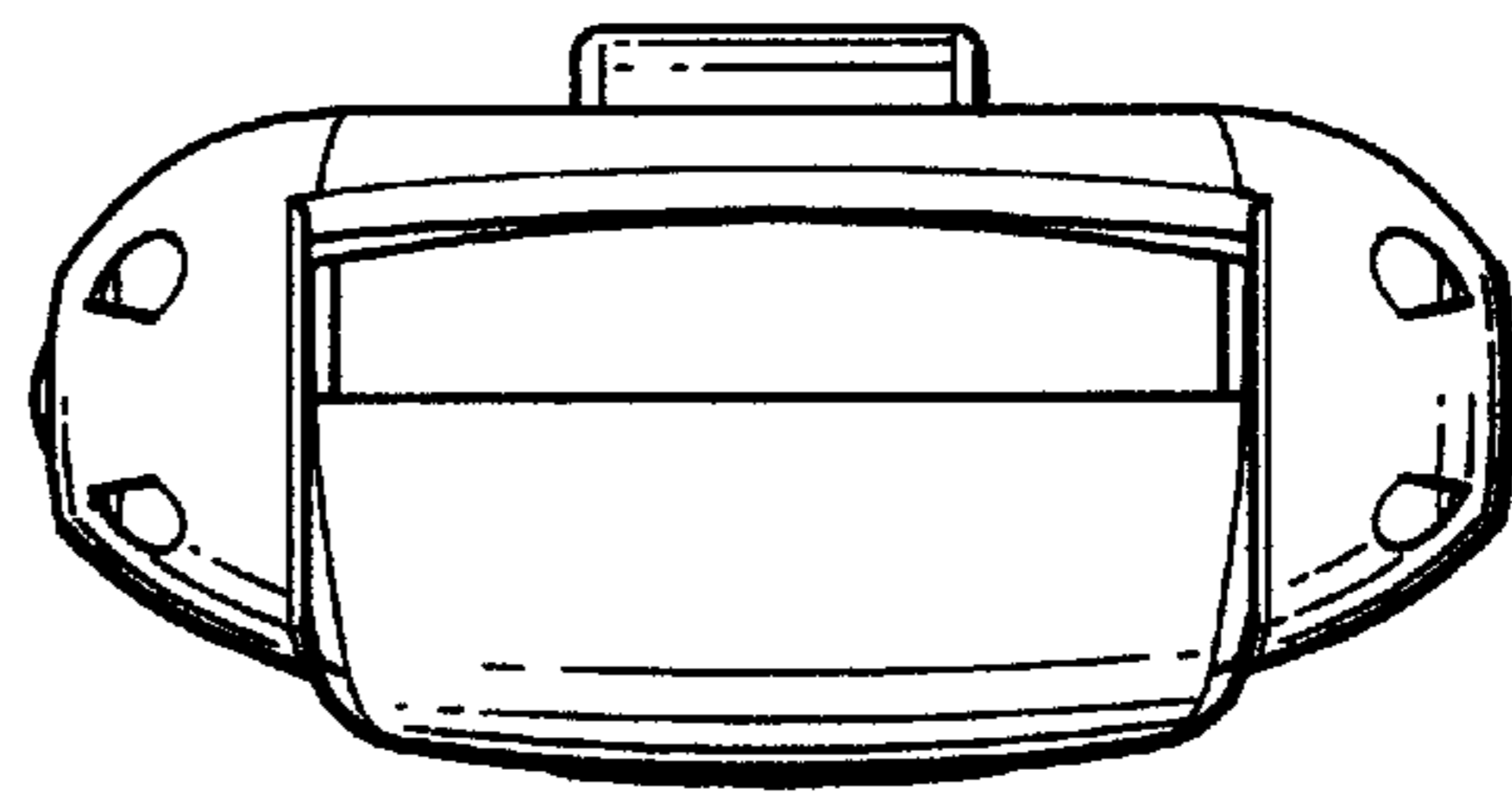

Fig. 2.

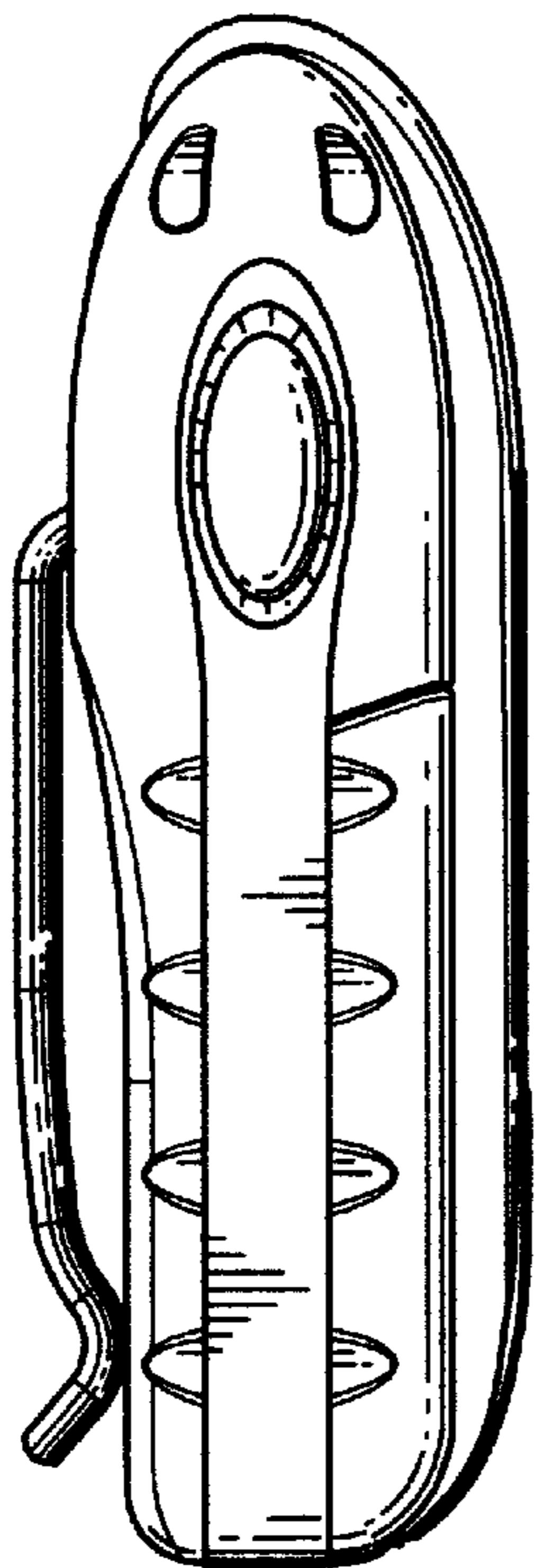

Fig. 3.

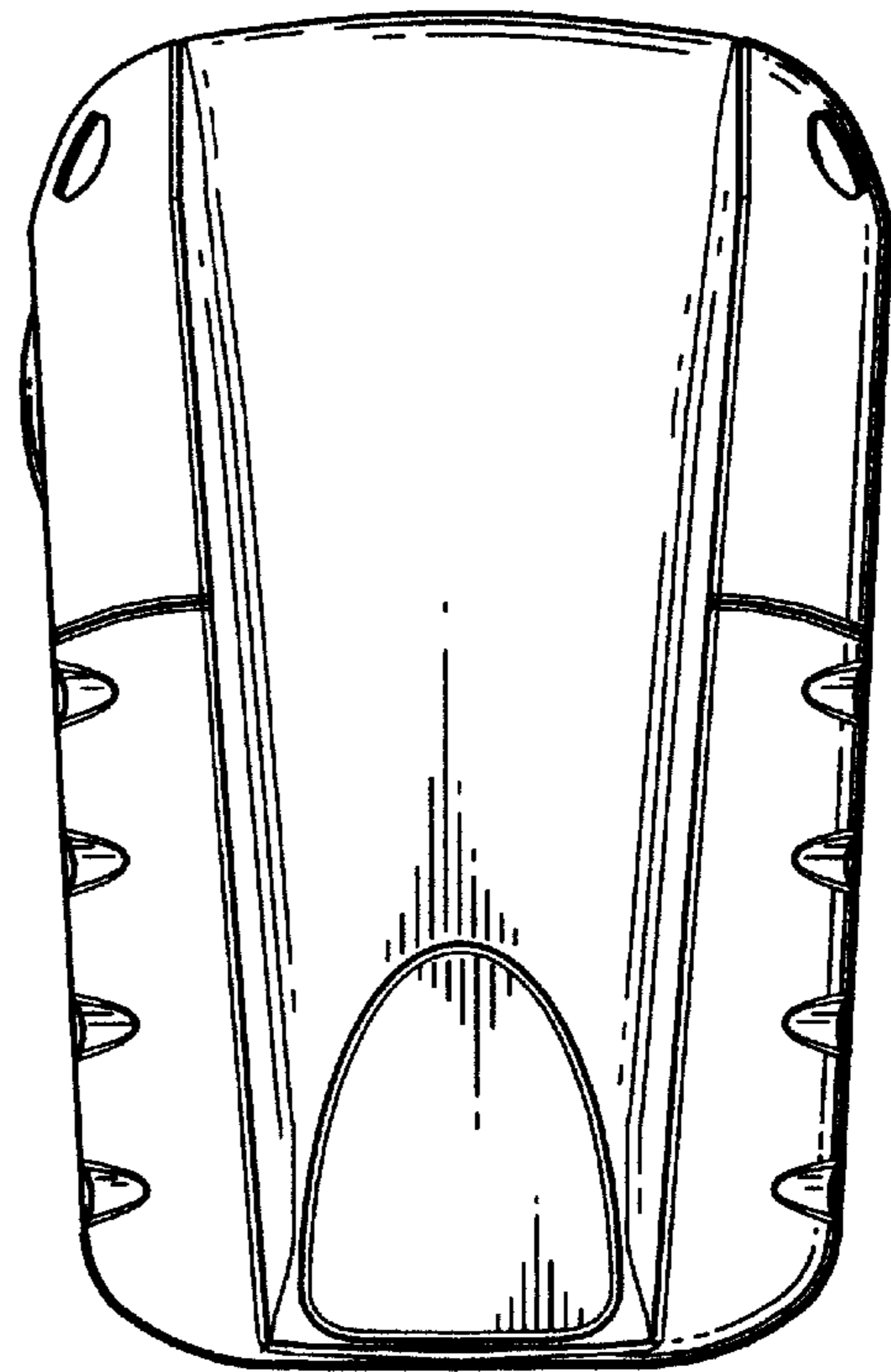

Fig. 4.

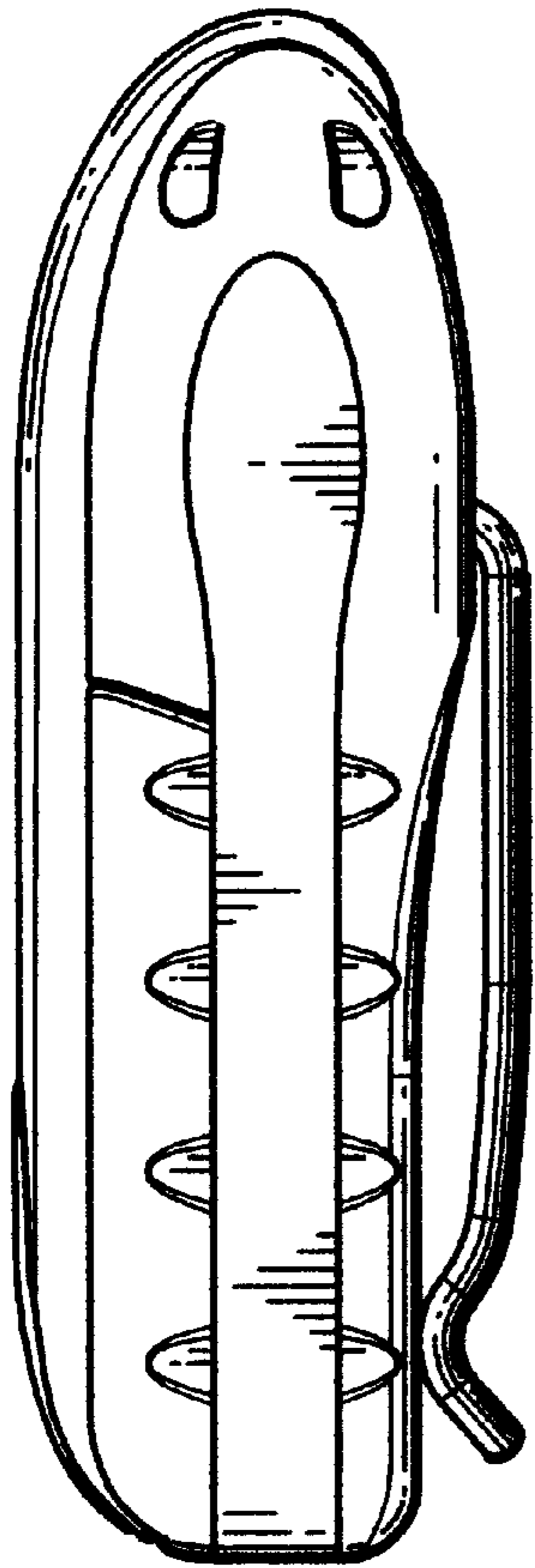

Fig. 5.

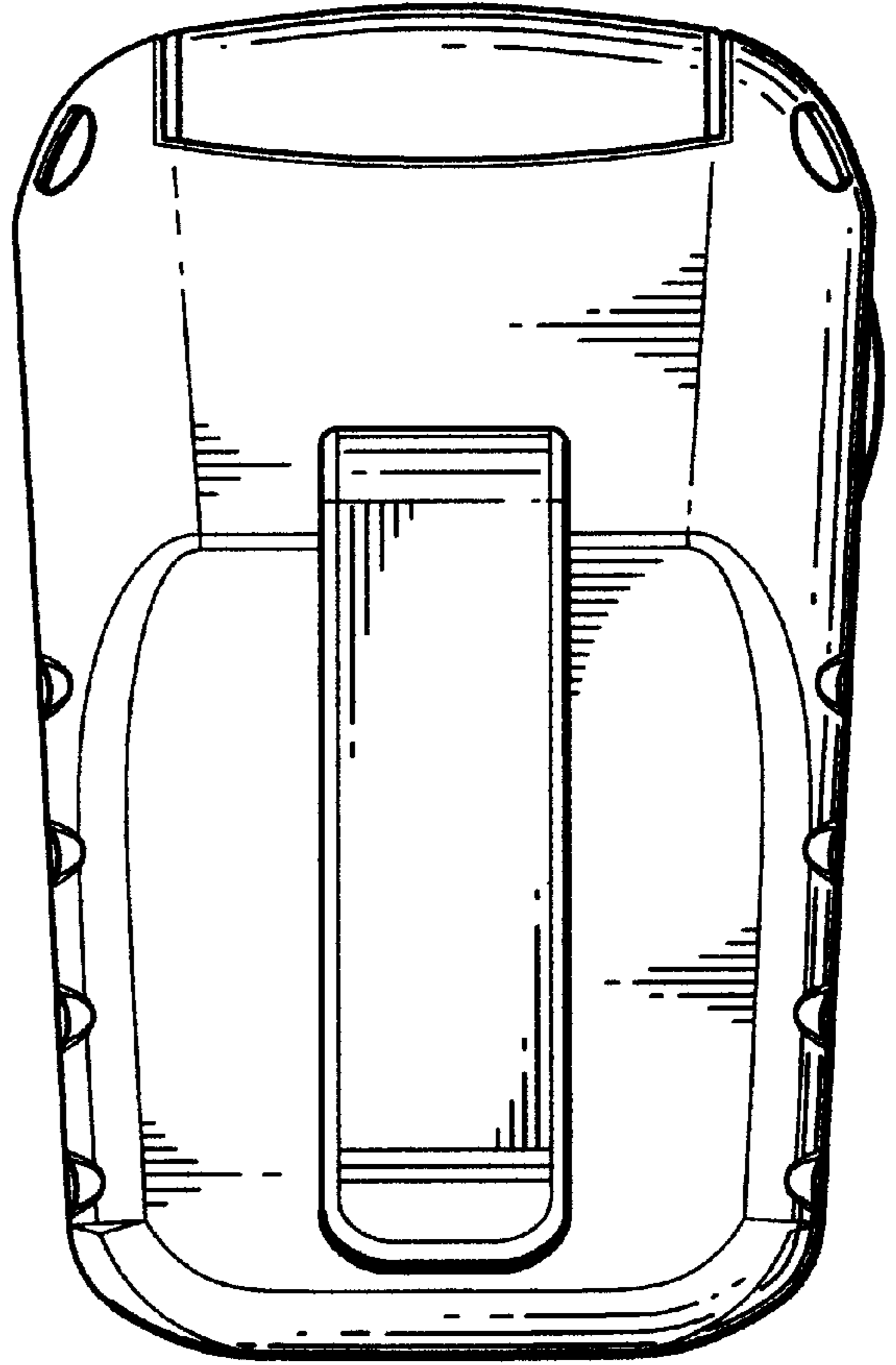

Fig. 6.

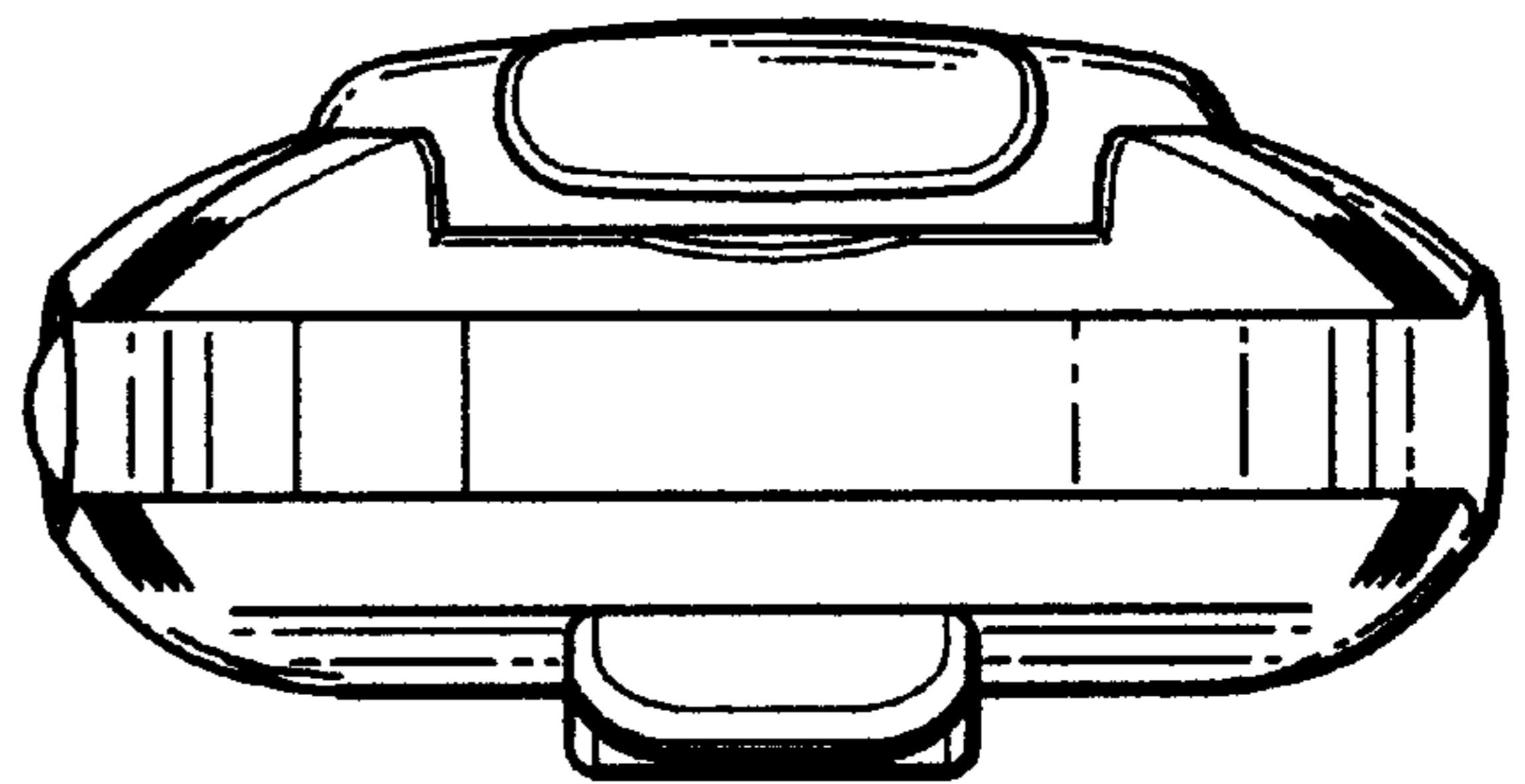

Fig. 7.

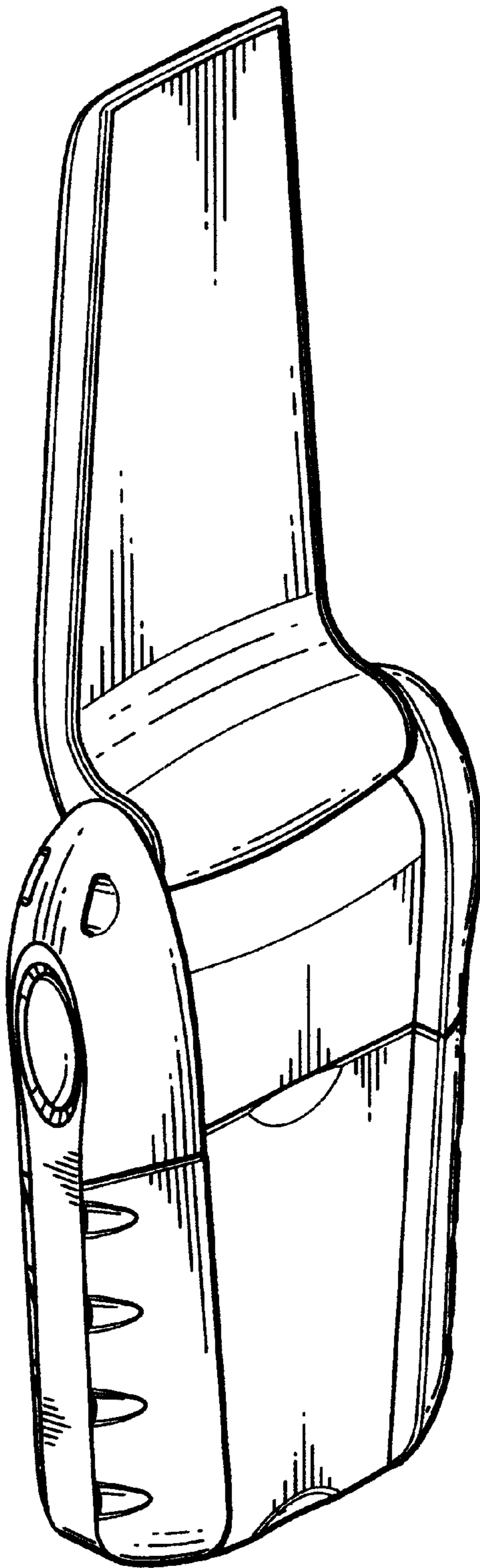

Fig. 8.

UNITED STATES PATENT AND TRADEMARK OFFICE
CERTIFICATE OF CORRECTION

PATENT NO. : Des. 464,453 S
DATED : October 15, 2002
INVENTOR(S) : Steven M. Cramer, Angela T. den Hoed and Robert G. Martinez

Page 1 of 1

It is certified that error appears in the above-identified patent and that said Letters Patent is hereby corrected as shown below:

Title page,

Item [75], replace "**Angela T. Hoed**" with -- **Angela T. den Hoed** --

Signed and Sealed this

Twenty-fifth Day of February, 2003

A handwritten signature in black ink, appearing to read "James E. Rogan", with a horizontal line drawn underneath it.

JAMES E. ROGAN
Director of the United States Patent and Trademark Office