



US00D464416S

(12) **United States Design Patent**
von Dohlen et al.

(10) **Patent No.:** **US D464,416 S**

(45) **Date of Patent:** **** Oct. 15, 2002**

(54) **PLUG-IN AEROSOL DISPENSER**
(75) Inventors: **Chris von Dohlen**, Columbus, OH
(US); **Luke Stonis**, Columbus, OH
(US)

(73) Assignee: **S. C. Johnson & Son, Inc.**, Racine, WI
(US)

(**) Term: **14 Years**

(21) Appl. No.: **29/144,051**

(22) Filed: **Jun. 25, 2001**

(51) **LOC (7) Cl.** **23-04**

(52) **U.S. Cl.** **D23/366**

(58) **Field of Search** D23/366-369,
D23/355, 356-363; 422/305, 125; 239/136,
135; 392/392, 395, 403, 405; D9/259

(56) **References Cited**

U.S. PATENT DOCUMENTS

2,813,187 A	11/1957	Rovira	219/19
2,882,640 A	4/1959	Kopecky	43/129
D237,497 S	11/1975	Andreopoulos et al.	...	D23/150
4,119,096 A	10/1978	Drews	128/194
5,170,782 A	12/1992	Kocinski	128/200
D335,530 S	* 5/1993	Schimanski	D23/366
D393,901 S	4/1998	Kuhn	D23/368

D424,185 S	5/2000	Brown et al.	D23/368
D432,222 S	10/2000	Rymer et al.	D23/366
D437,636 S	* 2/2001	Basaganas	D23/360
D447,550 S	* 9/2001	Basaganas	D23/366

* cited by examiner

Primary Examiner—Lisa Lichtenstein

(57) **CLAIM**

The ornamental design for an plug-in aerosol dispenser, as shown and described.

DESCRIPTION

FIG. 1 is a perspective view taken from in front of and above an plug-in aerosol dispenser incorporating the new design; FIG. 2 is a front elevational view of the plug-in aerosol dispenser of FIG. 1; FIG. 3 is a first side elevational view of the plug-in aerosol dispenser of FIG. 1; FIG. 4 is a rear elevational view of the plug-in aerosol dispenser of FIG. 1; FIG. 5 is a second side elevational view of the plug-in aerosol dispenser of FIG. 1; FIG. 6 is a top view of the plug-in aerosol dispenser of FIG. 1; and, FIG. 7 is a bottom view of the plug-in aerosol dispenser of FIG. 1.

1 Claim, 3 Drawing Sheets

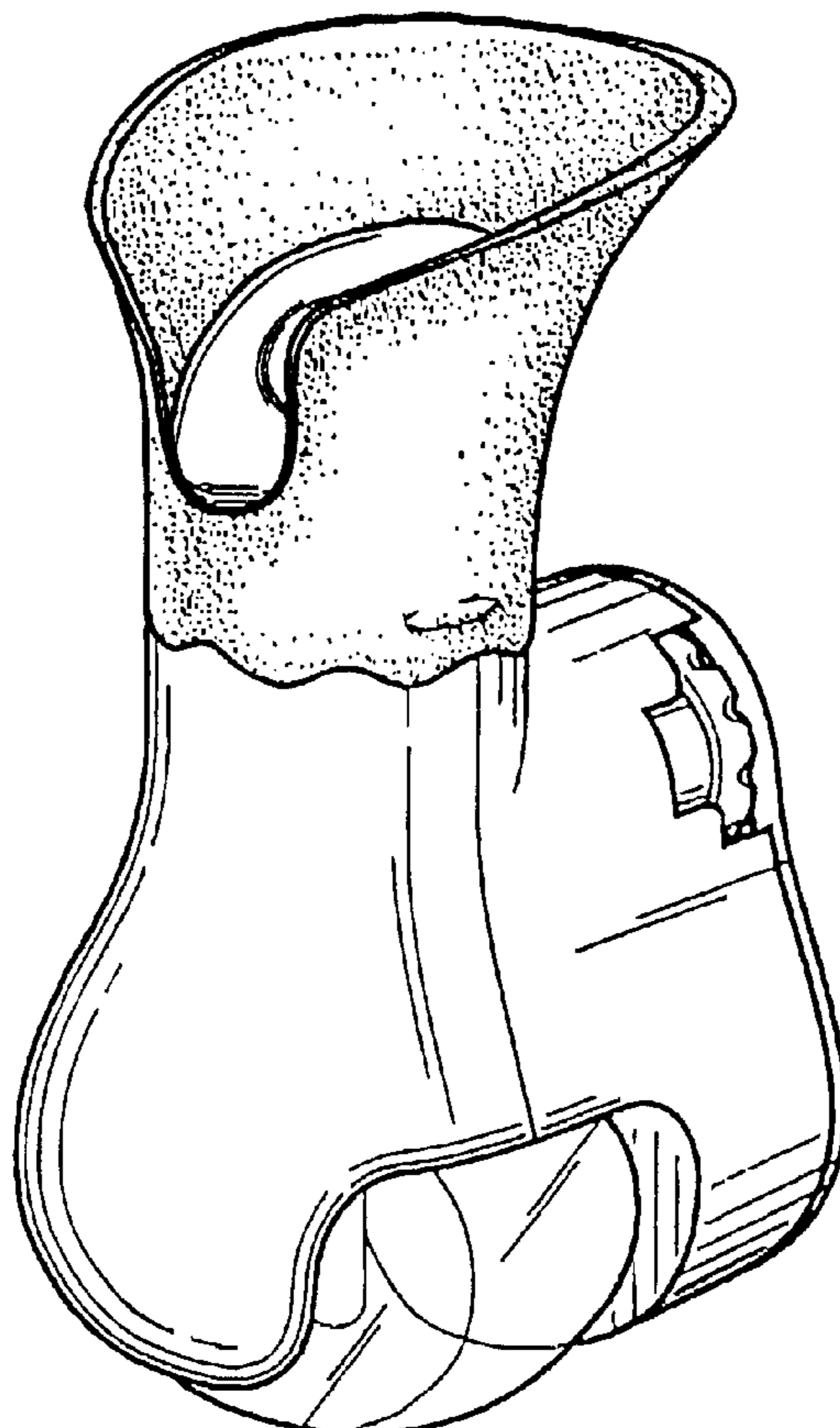

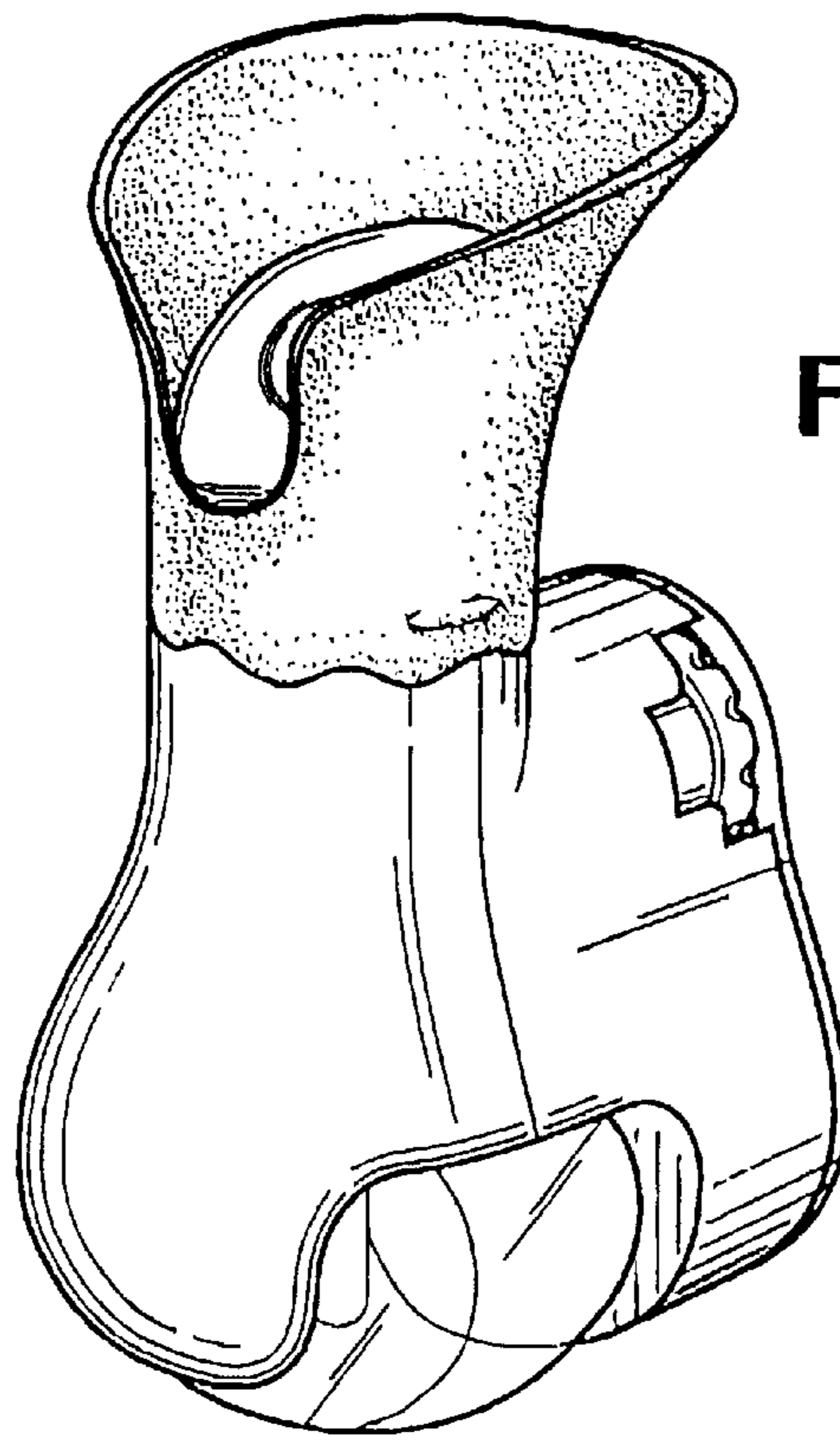

FIG. 1

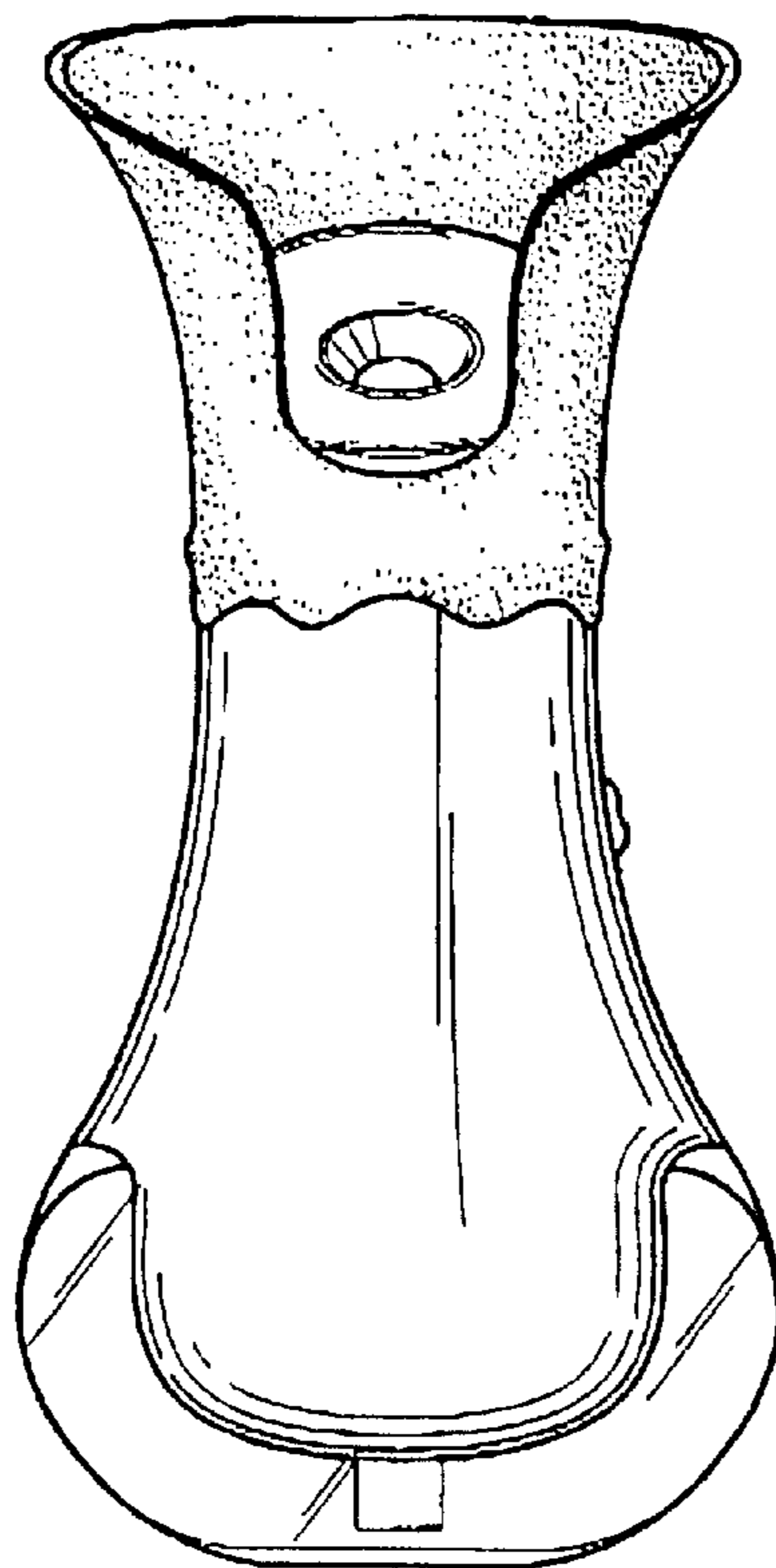

FIG. 2

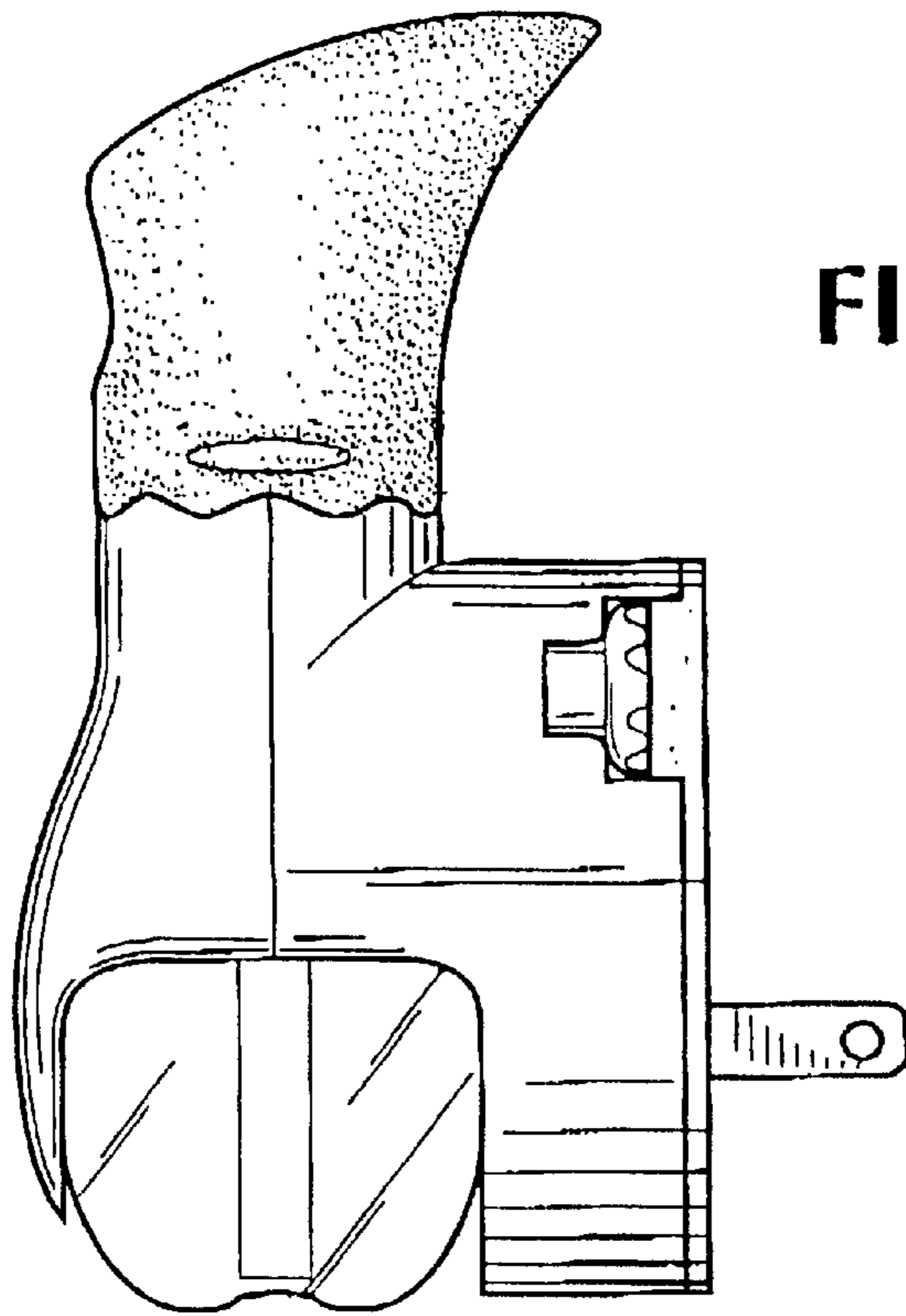

FIG. 3

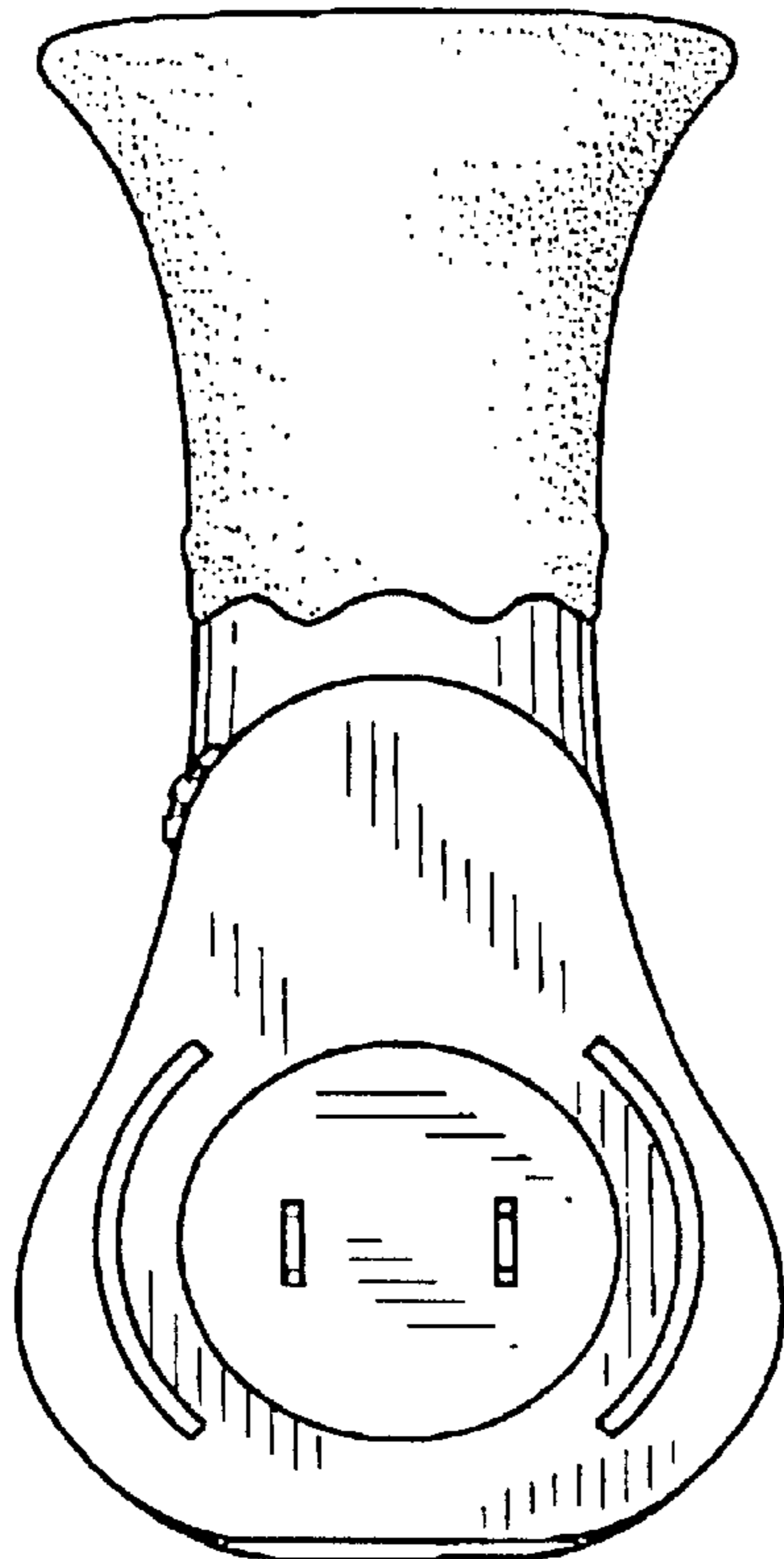

FIG. 4

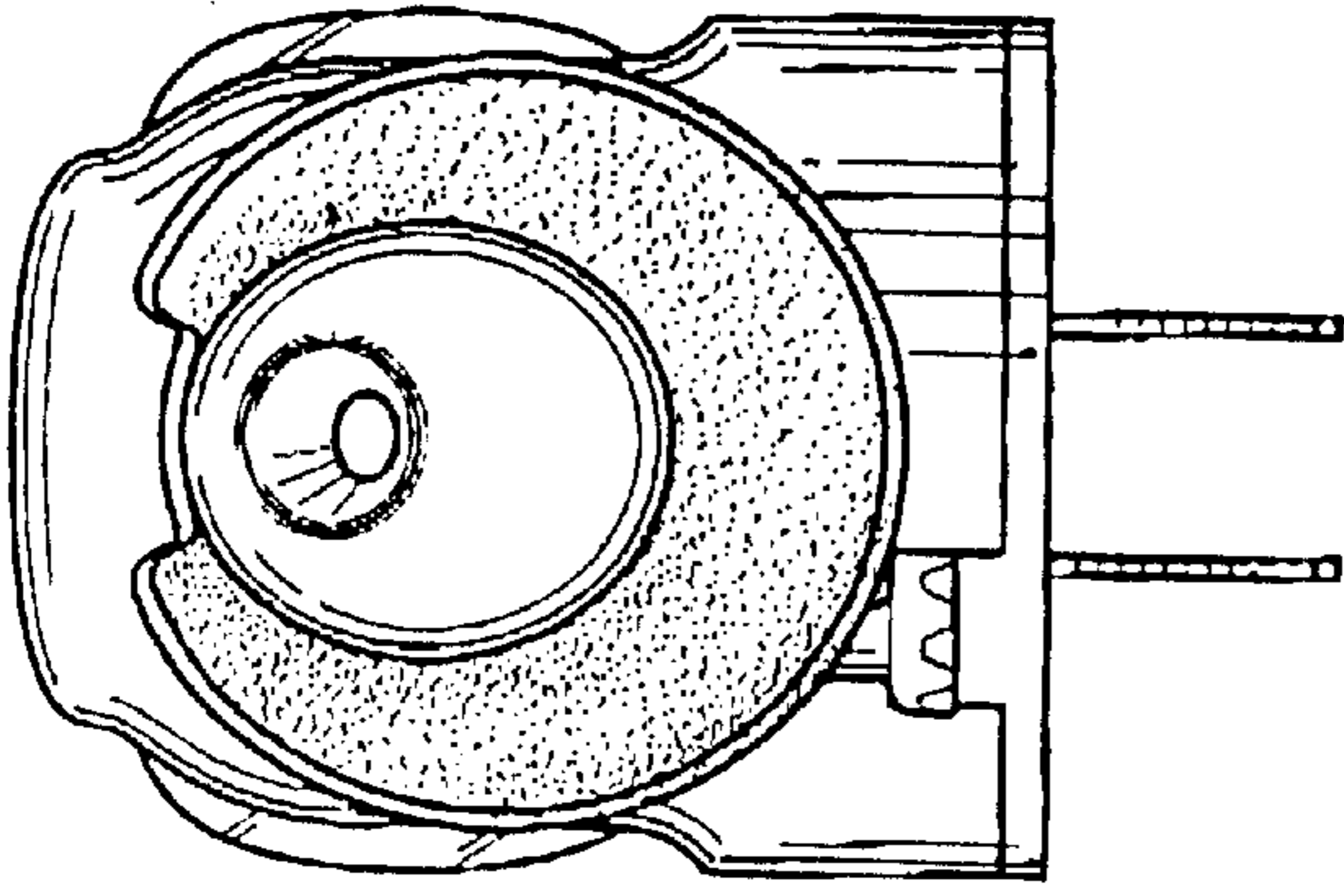

FIG. 6

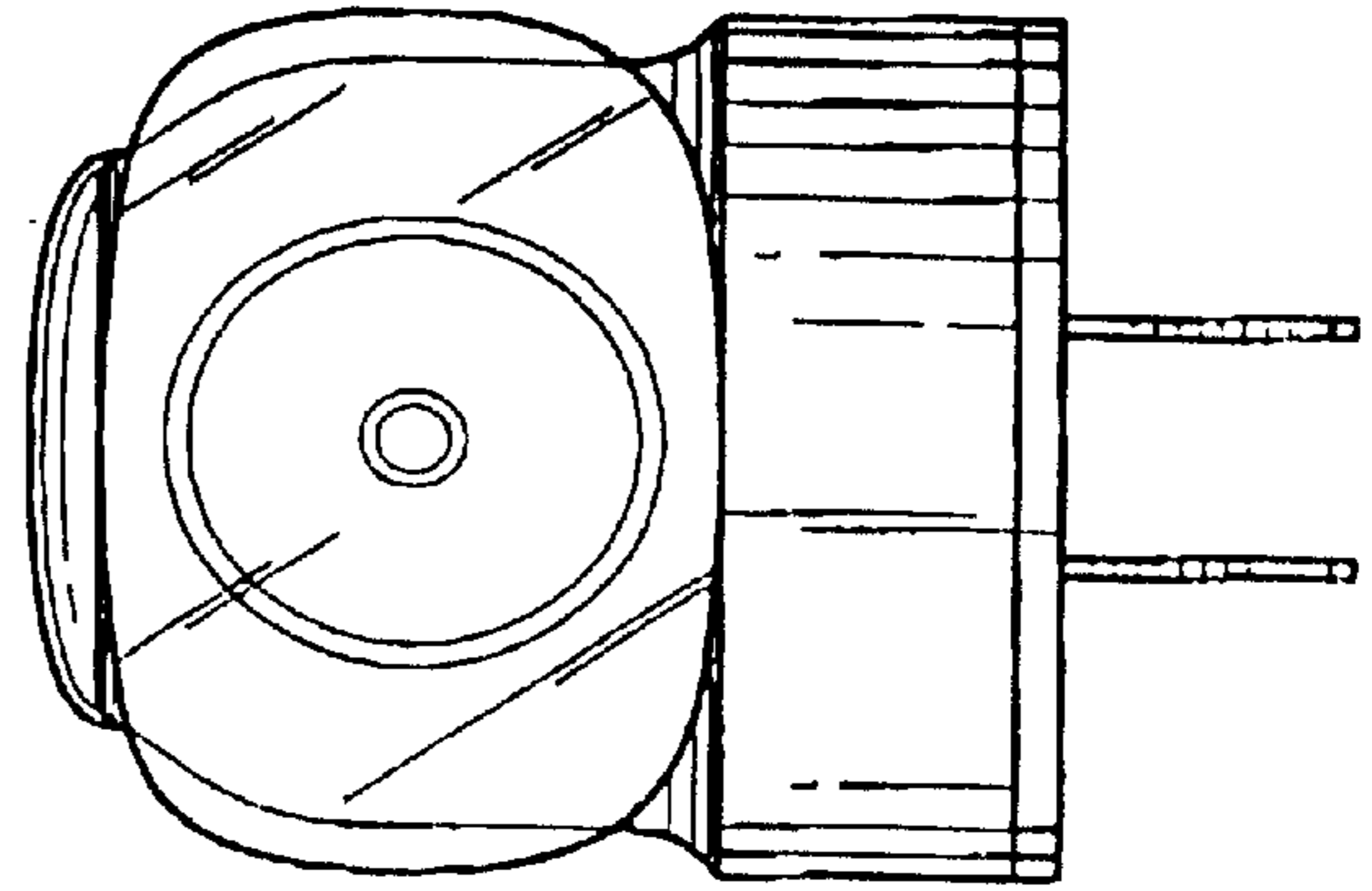

FIG. 7

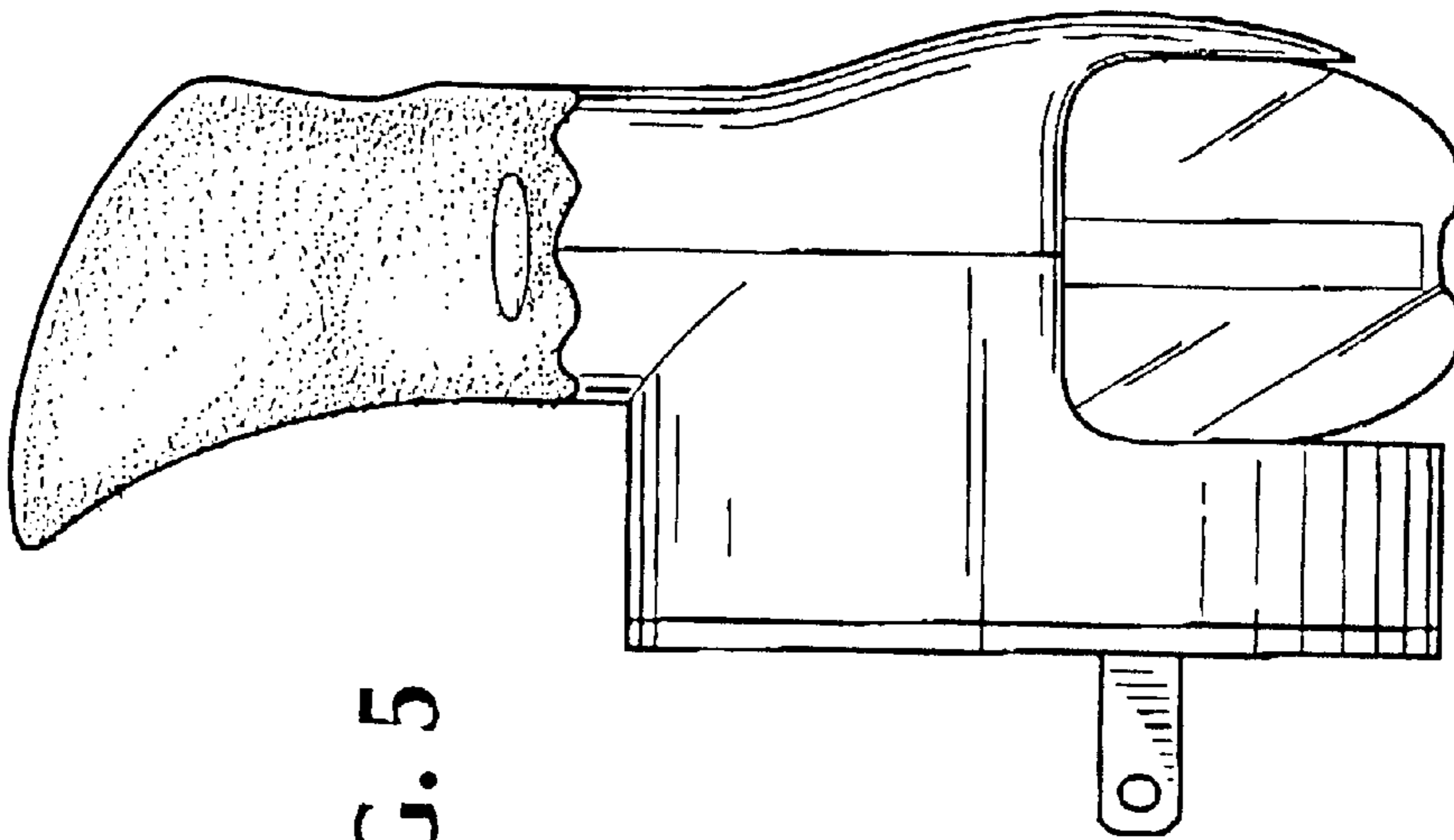

FIG. 5