



US00D464356S

(12) **United States Design Patent**
Chien et al.

(10) **Patent No.:** **US D464,356 S**

(45) **Date of Patent:** **** Oct. 15, 2002**

(54) **COMPUTER FRONT BEZEL**

(75) Inventors: **Chieh Nan Chien**, Taipei (TW); **Yin Sheng Yeh**, Taipei (TW)

(73) Assignee: **Hon Hai Precision Ind. Co., Ltd.**, Taipei Hsien (TW)

(**) Term: **14 Years**

(21) Appl. No.: **29/145,671**

(22) Filed: **Jul. 26, 2001**

(30) **Foreign Application Priority Data**

Jun. 15, 2001 (TW) 090304014

(51) **LOC (7) Cl.** **14-02**

(52) **U.S. Cl.** **D14/444**

(58) **Field of Search** D14/441-446;
D13/162, 184, 199; 312/223.1-223.3; 361/690-696

(56) **References Cited**

U.S. PATENT DOCUMENTS

D415,750 S	*	10/1999	Jean et al.	D14/444
D429,731 S	*	8/2000	Jean et al.	D14/441
D432,135 S	*	10/2000	Jean et al.	D14/444
D432,136 S	*	10/2000	Jean et al.	D14/444
D433,417 S	*	11/2000	Liu et al.	D14/441
D439,254 S	*	3/2001	Zhao	D14/441
D439,255 S	*	3/2001	Jean et al.	D14/444
D440,978 S	*	4/2001	Jean et al.	D14/444

* cited by examiner

Primary Examiner—Freda Nunn

(74) *Attorney, Agent, or Firm*—Wei Te Chung

(57) **CLAIM**

The ornamental design for a computer front bezel, as shown and described.

DESCRIPTION

FIG. 1 is a perspective view of a computer front bezel of our new design;

FIG. 2 is a front elevational view thereof;

FIG. 3 is a left side elevational view thereof;

FIG. 4 is a right side elevational view thereof;

FIG. 5 is a top plan view thereof;

FIG. 6 is a bottom plan view thereof;

FIG. 7 is a view similar to FIG. 1 with the computer front bezel being mounted to a computer case which is shown in broken lines for illustrative purposes only and forms no part of the claimed design;

FIG. 8 is a perspective view of a computer front bezel in accordance with an alternative embodiment of our new design;

FIG. 9 is a front elevational view of FIG. 8;

FIG. 10 is a rear elevational view of FIG. 8;

FIG. 11 is a left side elevational view of FIG. 8;

FIG. 12 is a right side elevational view of FIG. 8;

FIG. 13 is a top plan view of FIG. 8;

FIG. 14 is a bottom plan view of FIG. 8; and,

FIG. 15 is a view similar to FIG. 8 with the computer front bezel being mounted to a computer case which is shown in broken lines for illustrative purposes only and forms no part of the claimed design.

1 Claim, 11 Drawing Sheets

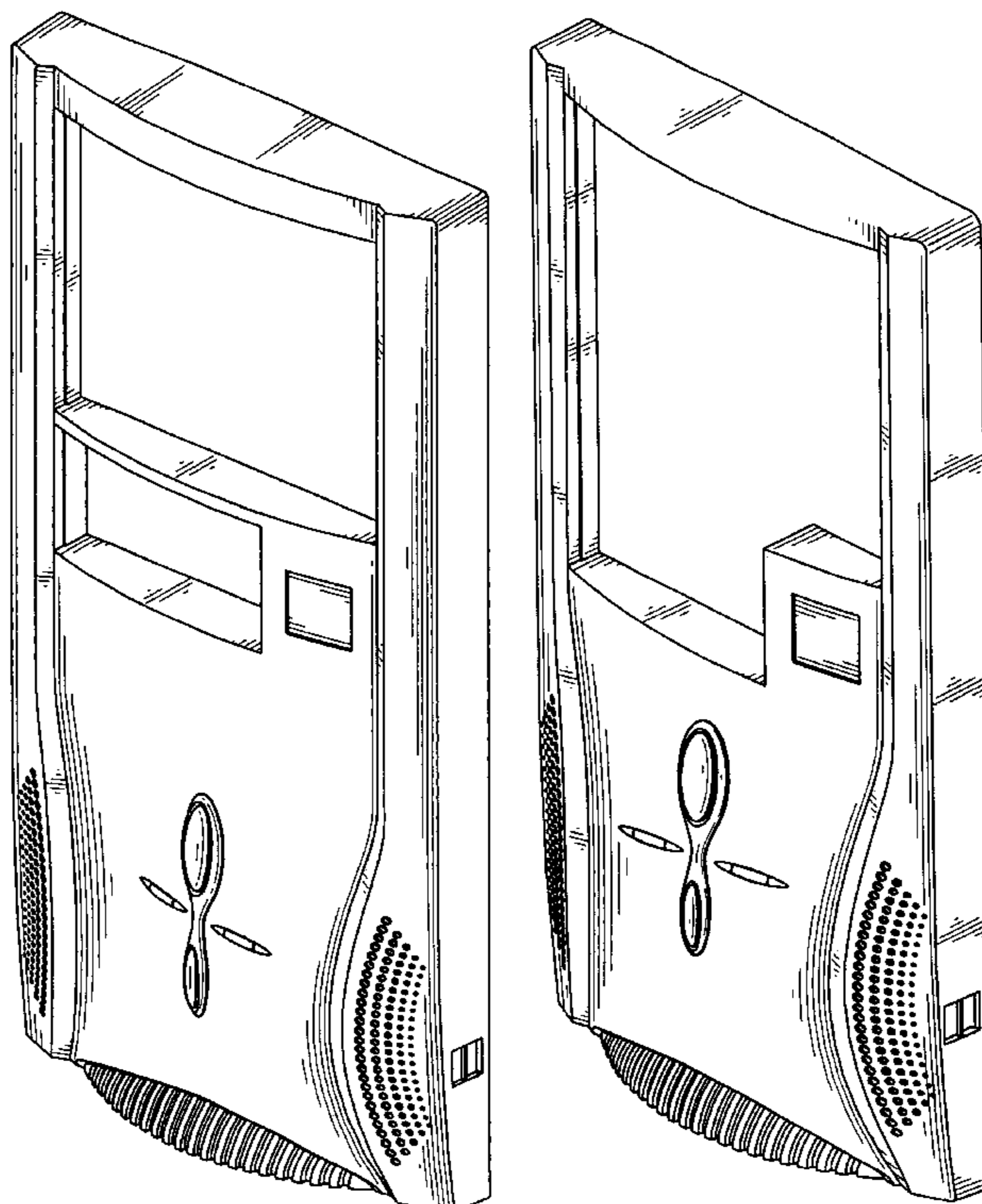

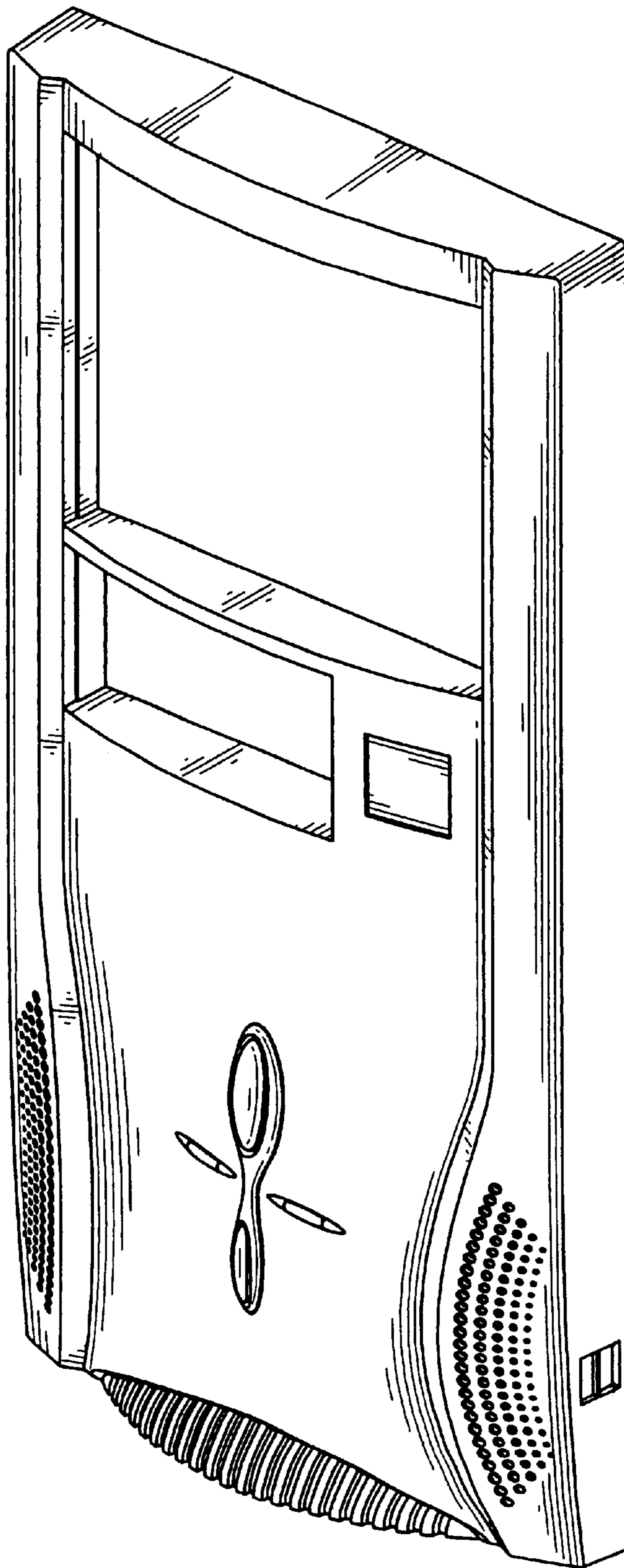

FIG. 1

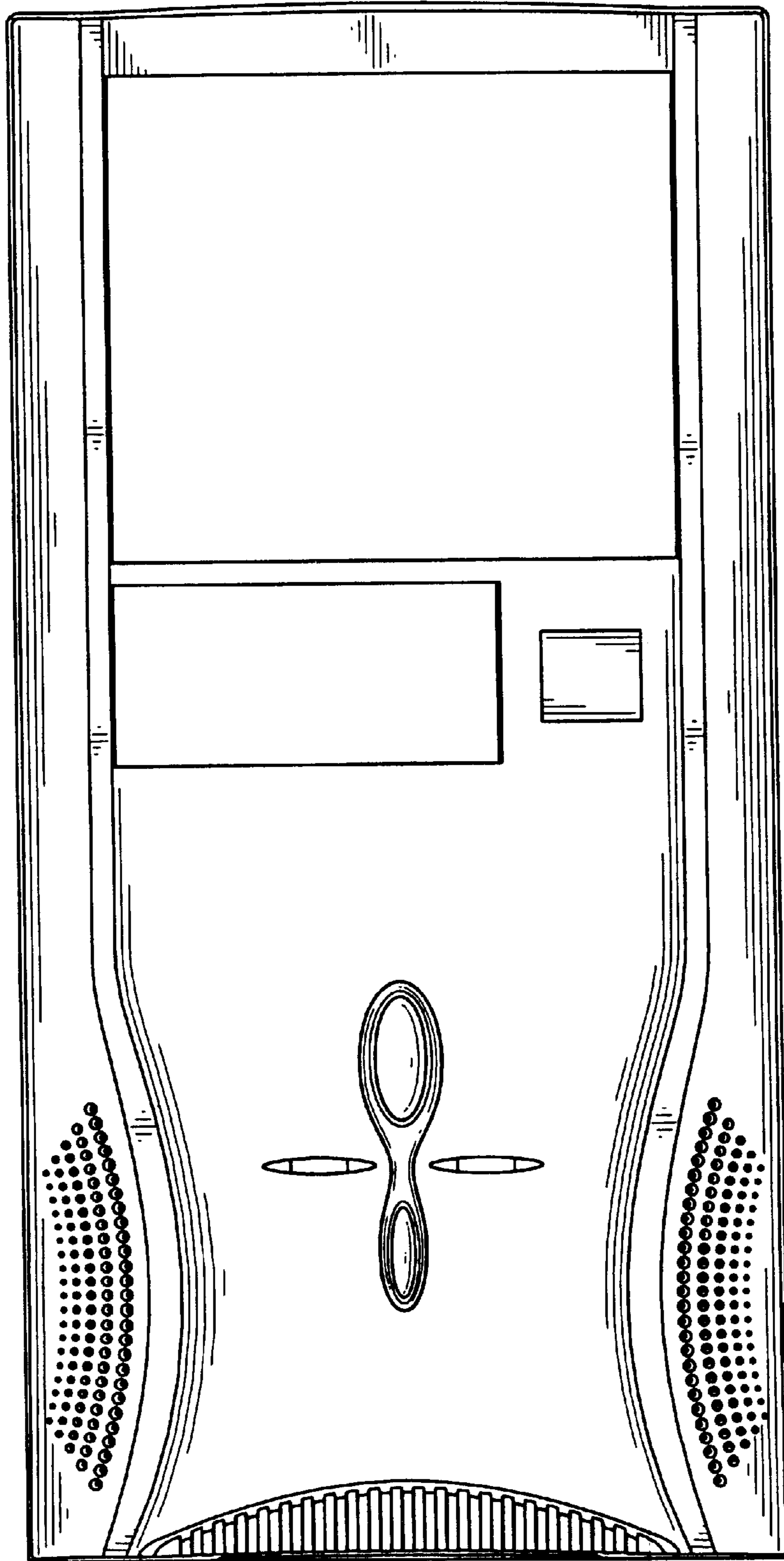

FIG. 2

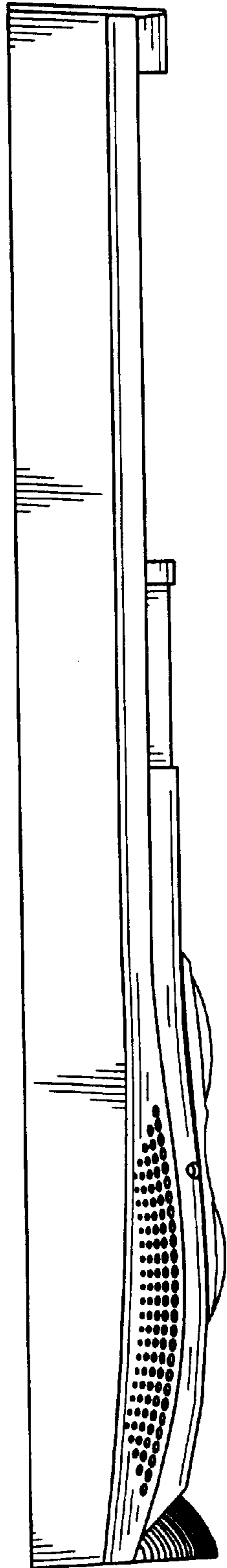

FIG. 3

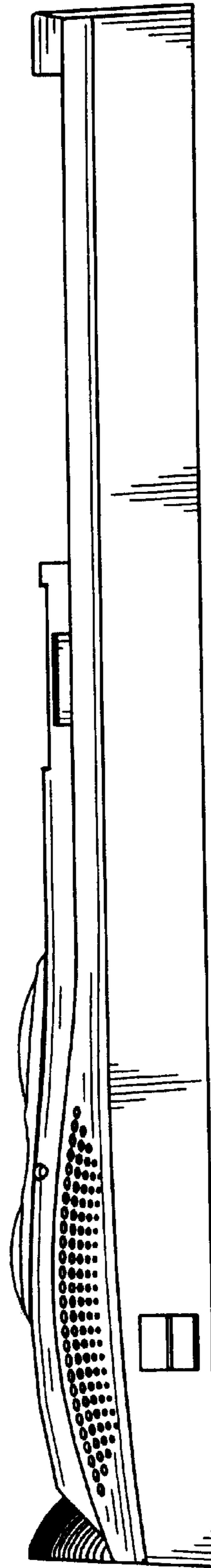

FIG. 4

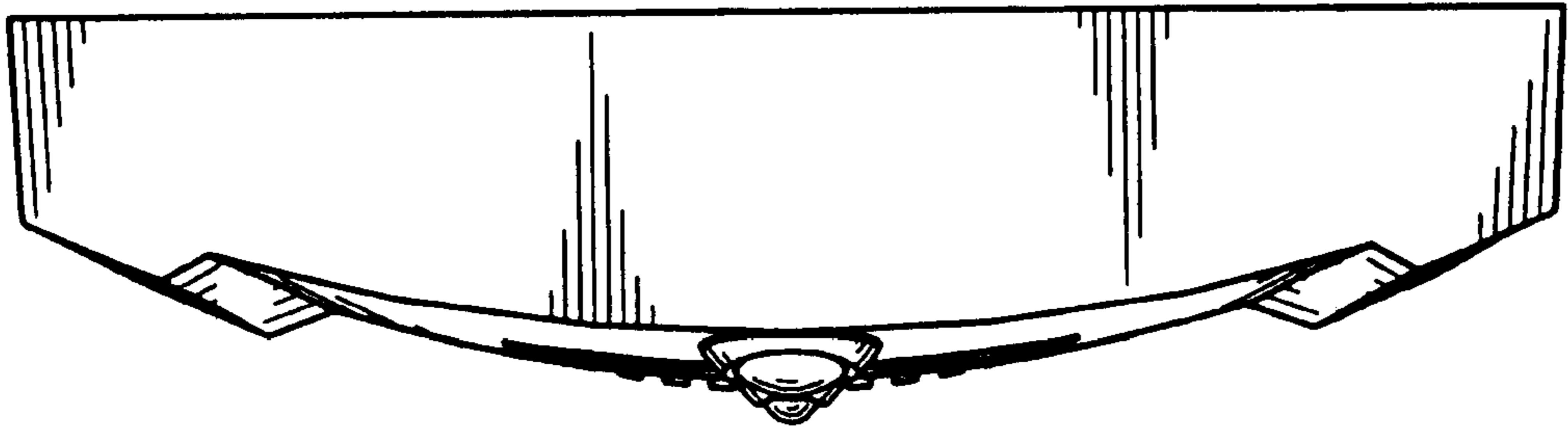

FIG. 5

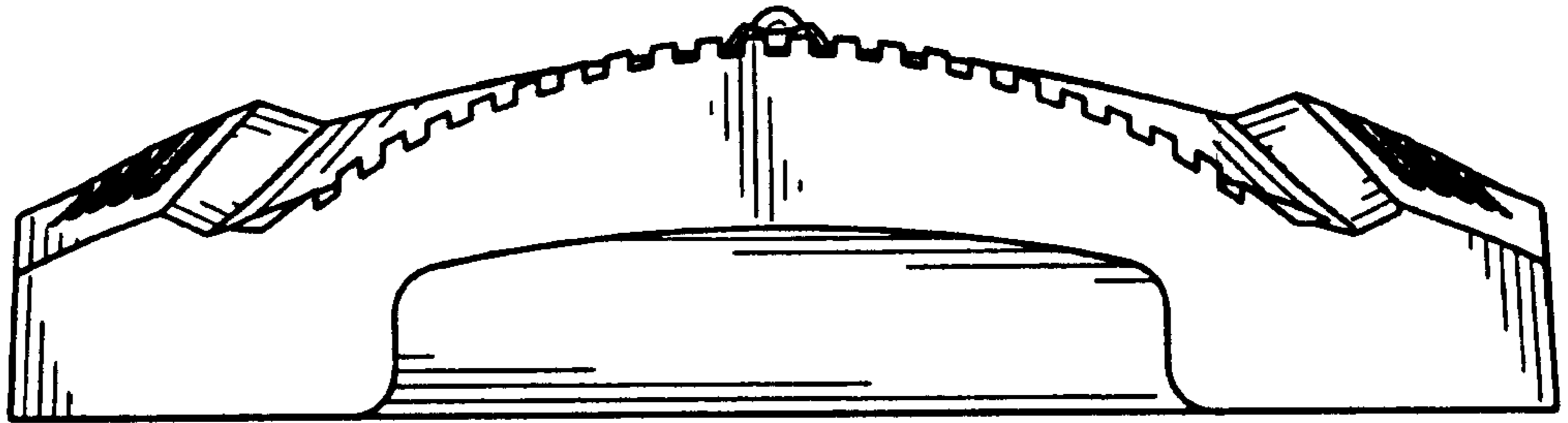

FIG. 6

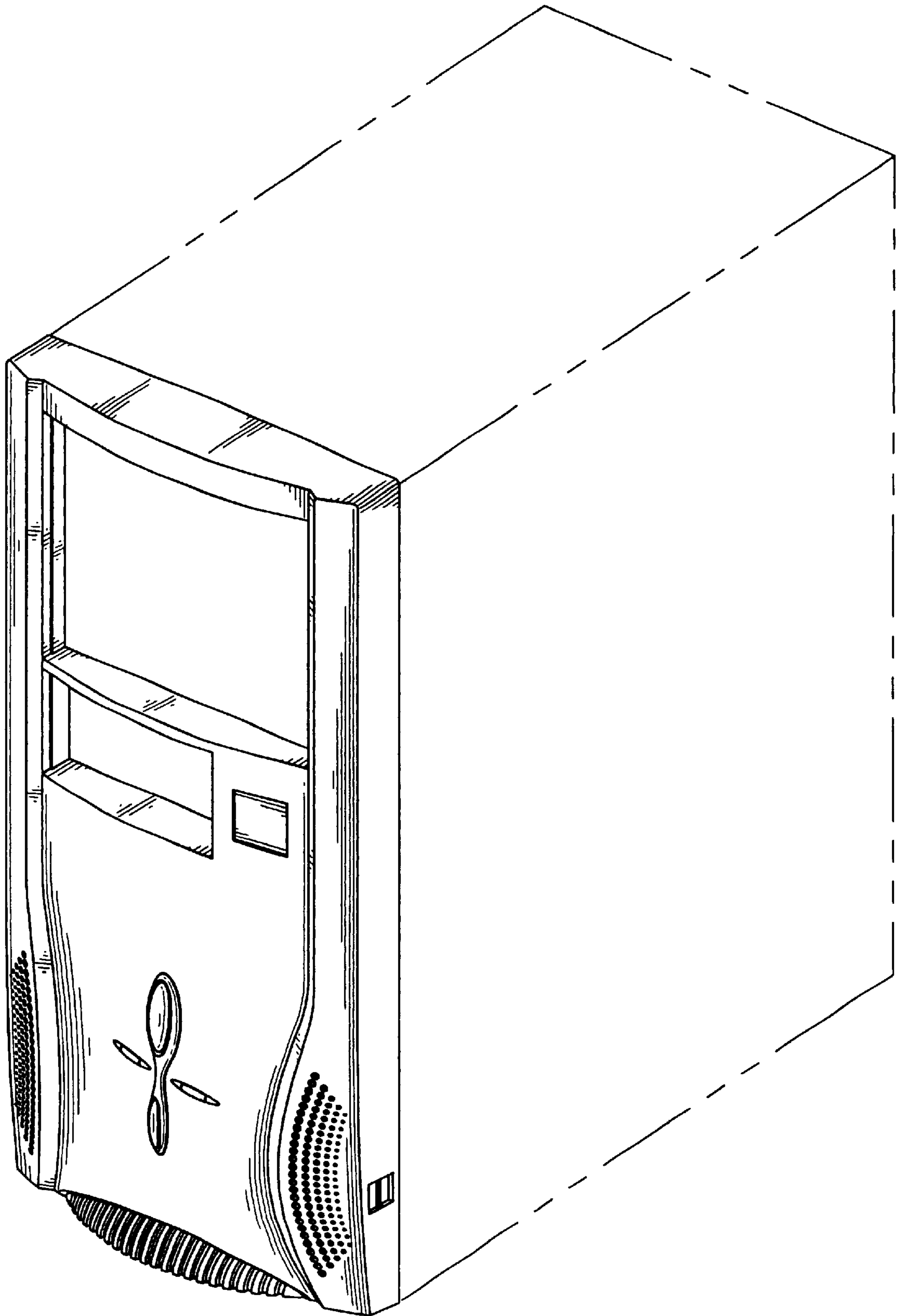

FIG. 7

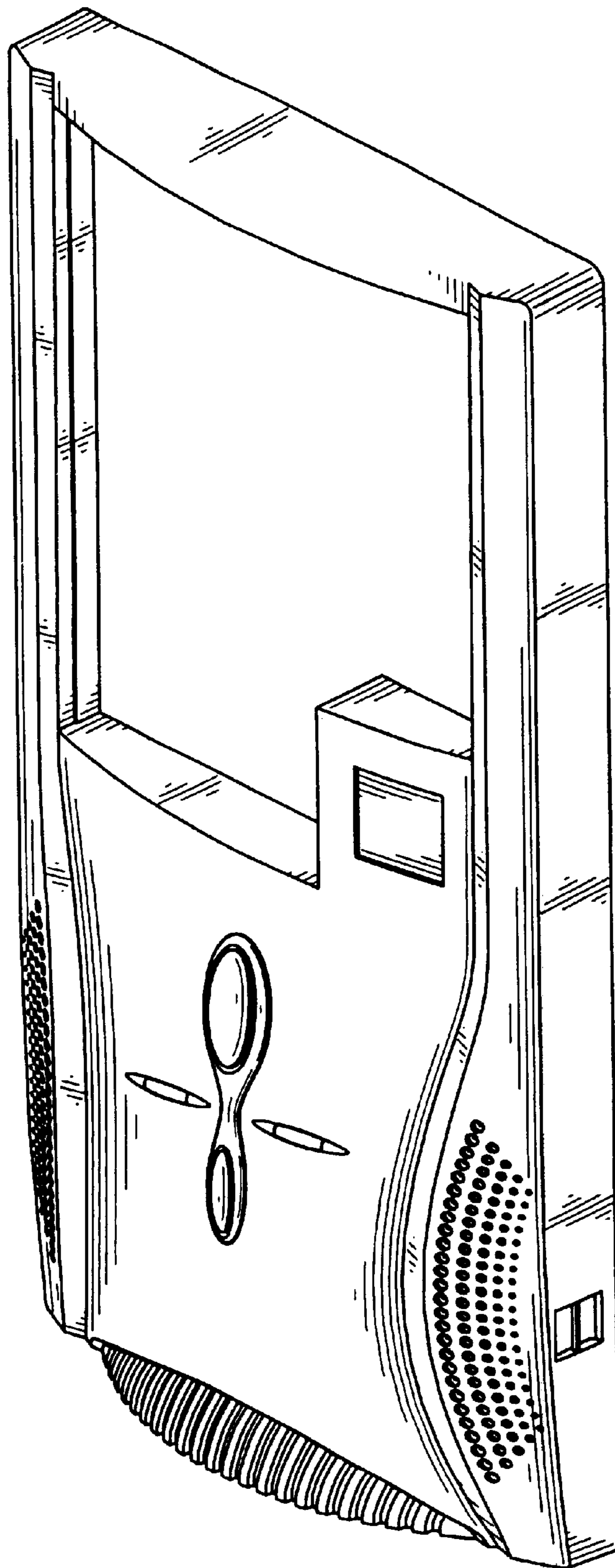

FIG. 8

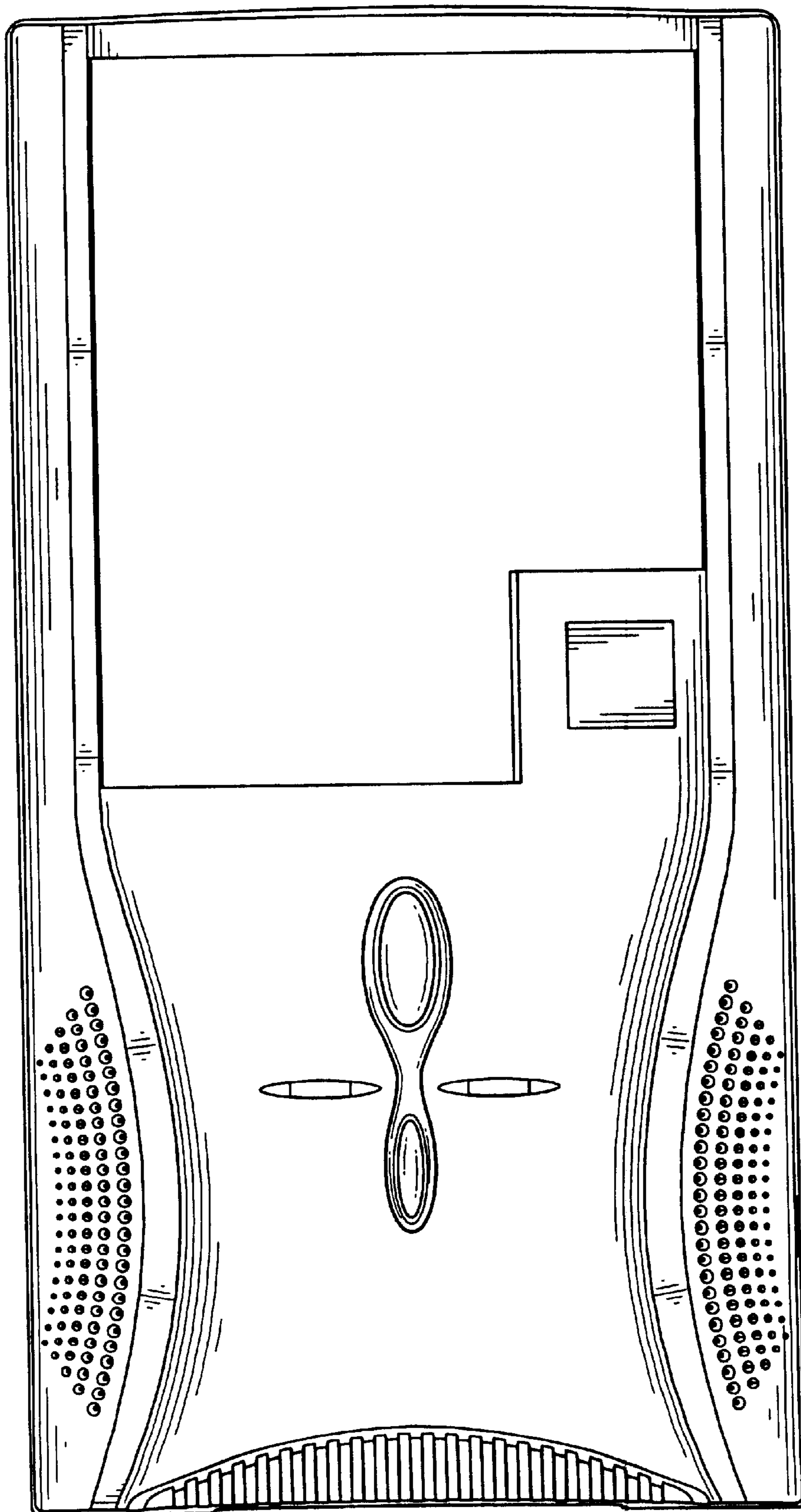

FIG. 9

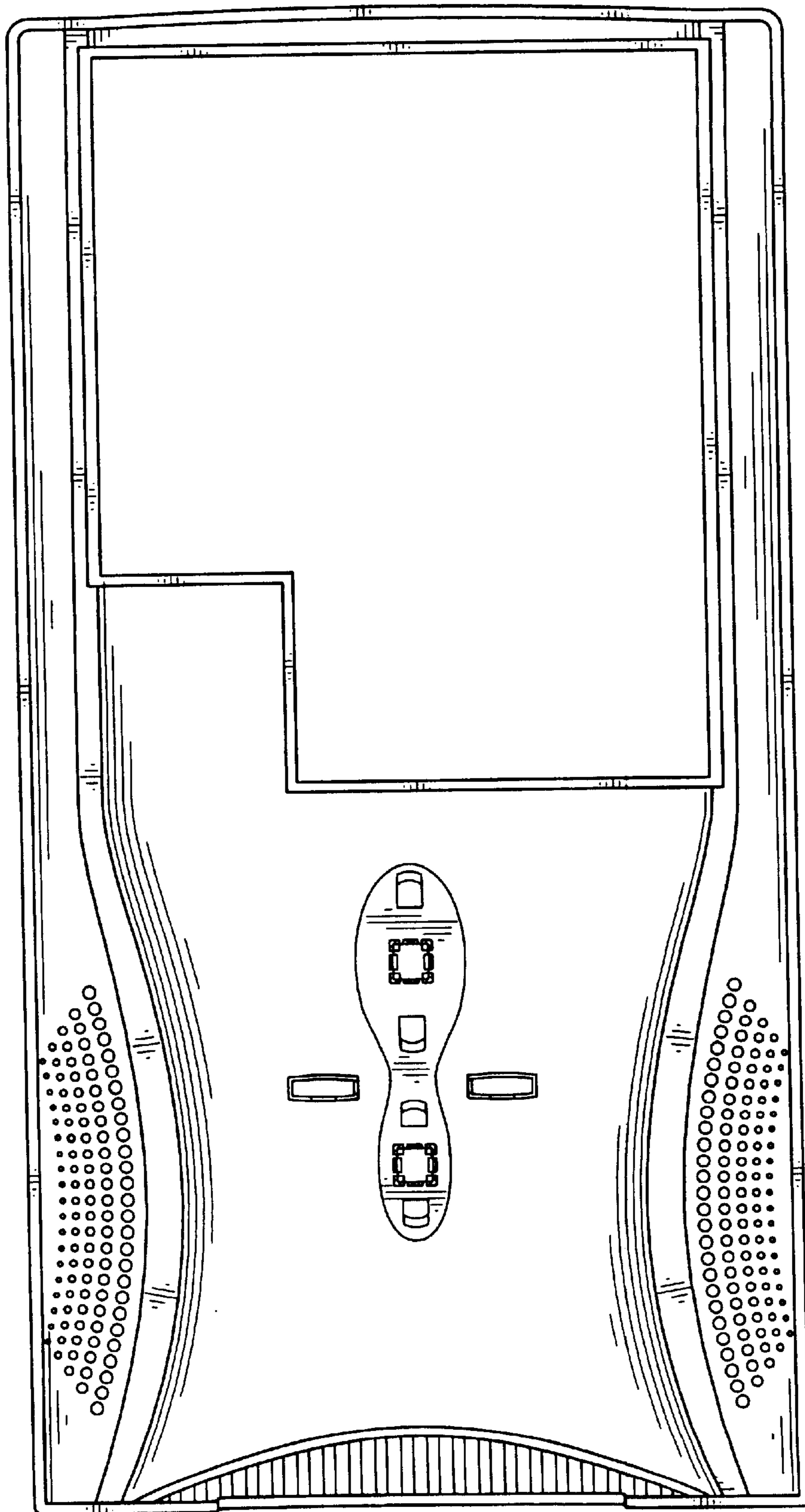

FIG. 10

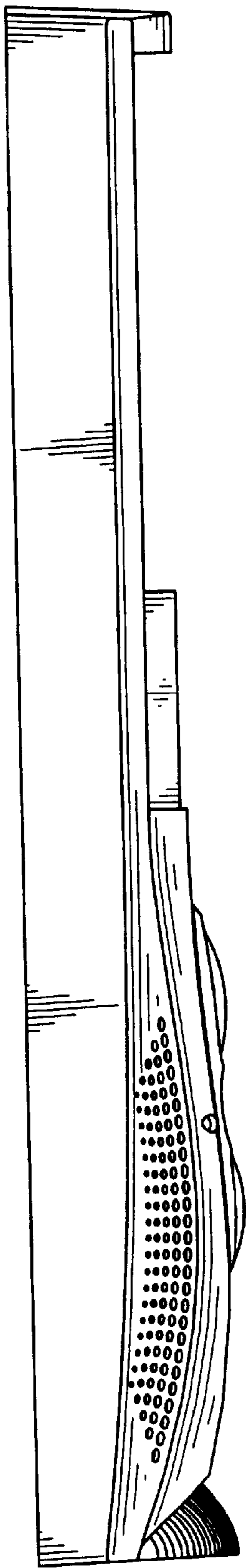

FIG. 11

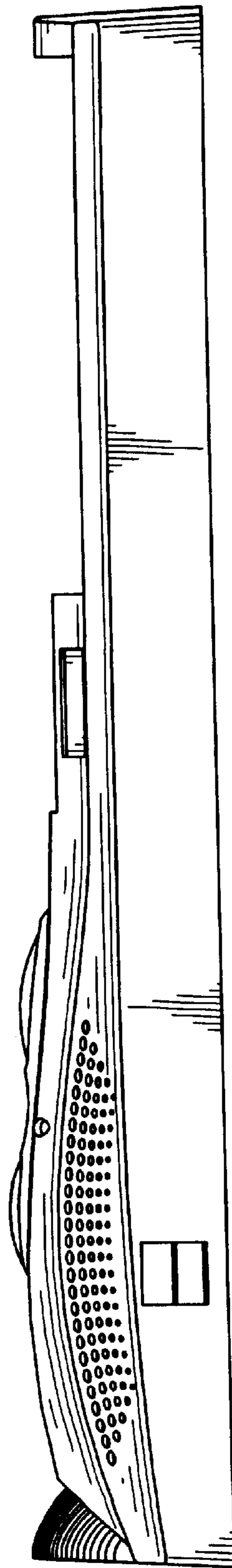

FIG. 12

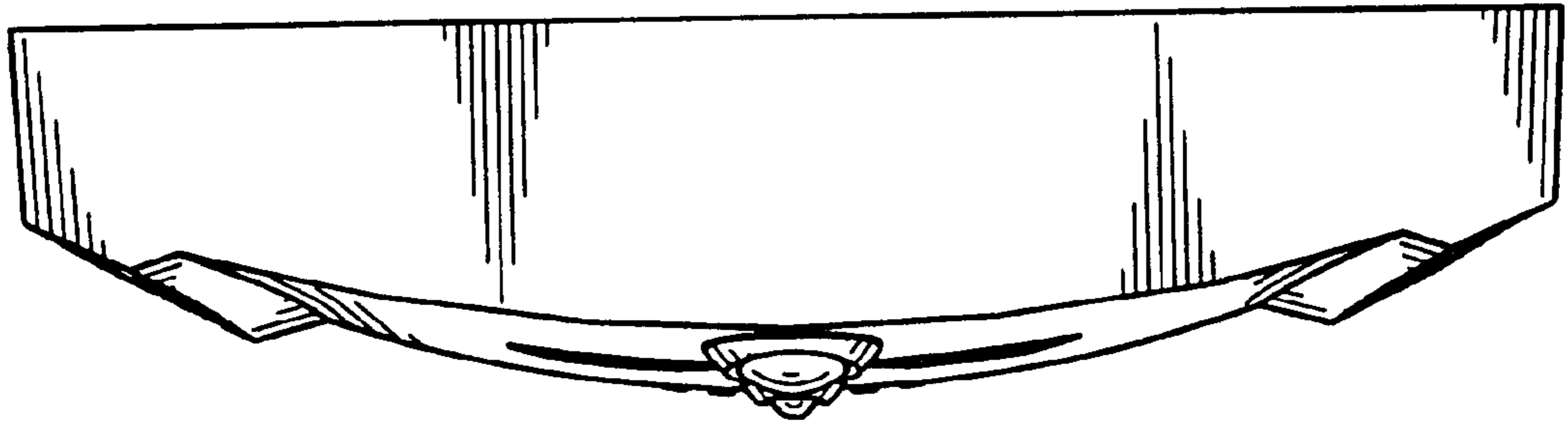

FIG. 13

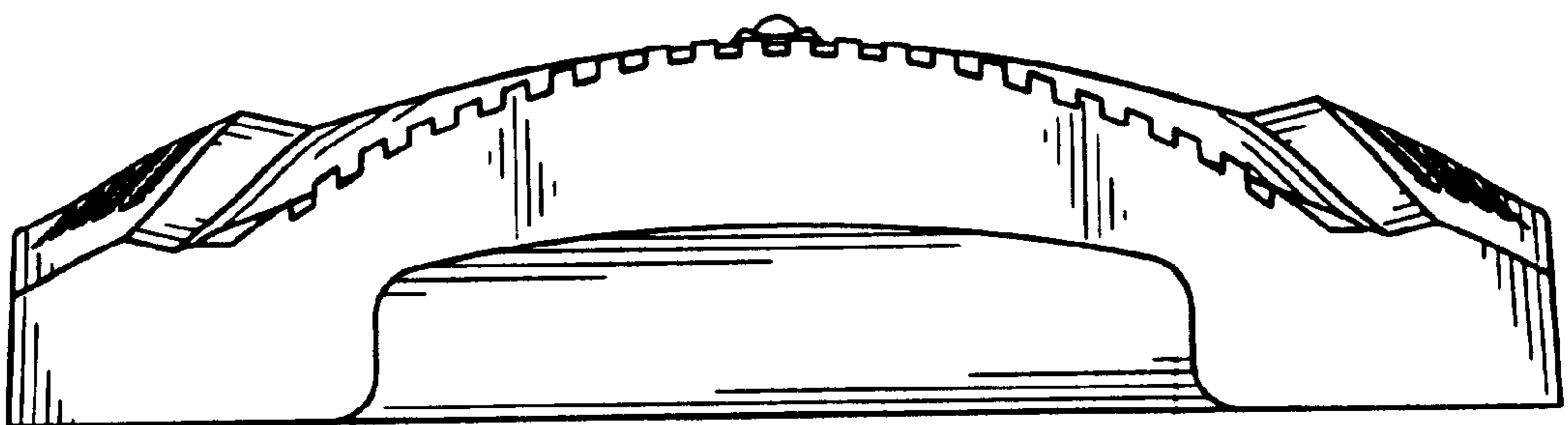

FIG. 14

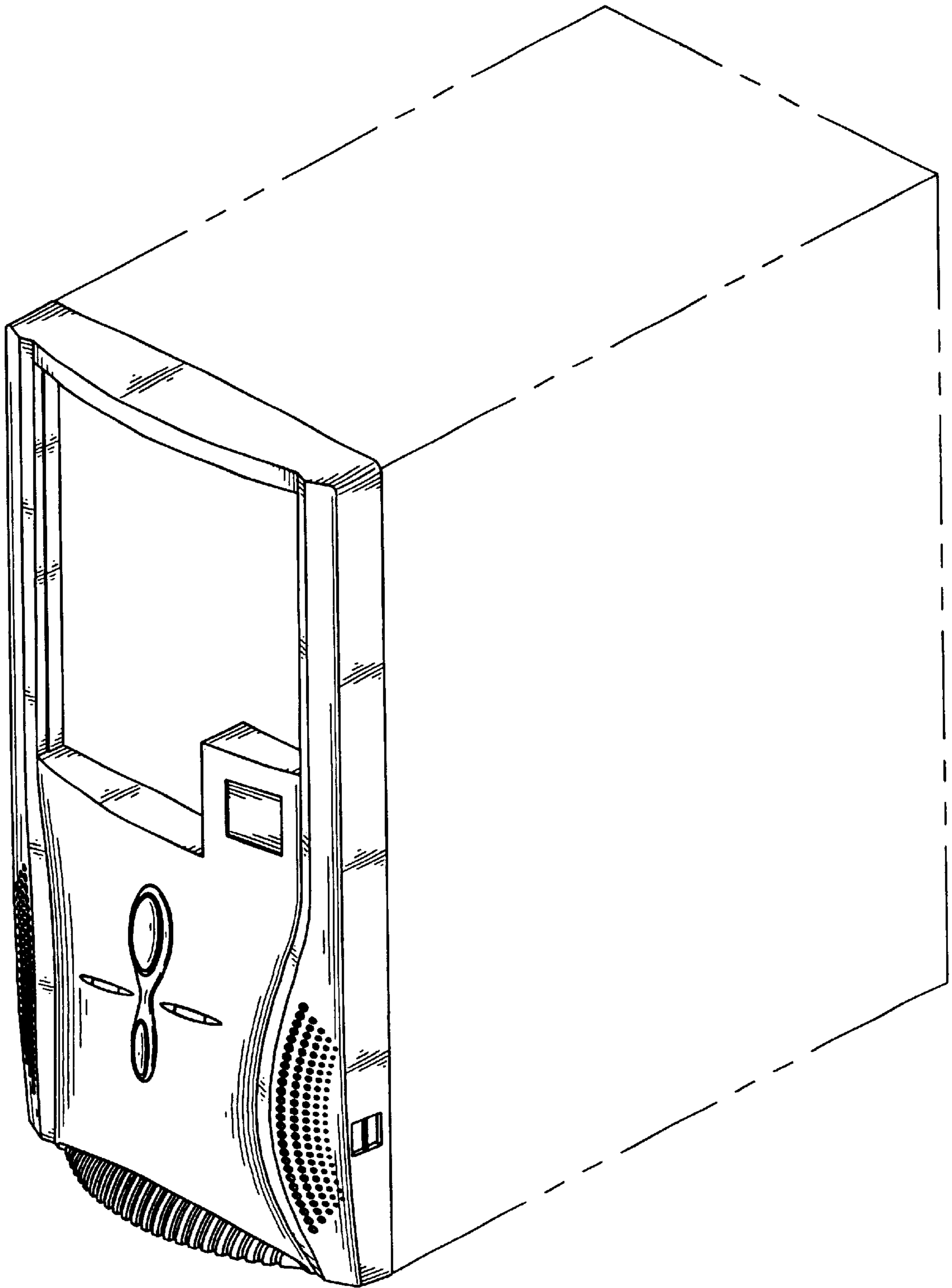

FIG. 15