



US00D464235S

(12) **United States Design Patent**  
**Jeong**

(10) **Patent No.:** **US D464,235 S**

(45) **Date of Patent:** **\*\* Oct. 15, 2002**

(54) **COOLER**

(76) **Inventor:** **Kyu-Hyun Jeong**, Jinho Bldg., 711-8,  
Jeongreung 3-dong, Seongbuk-ku, Seoul  
(KR)

(\*\*) **Term:** **14 Years**

(21) **Appl. No.:** **29/147,974**

(22) **Filed:** **Sep. 13, 2001**

(51) **LOC (7) Cl.** ..... **07-01**

(52) **U.S. Cl.** ..... **D7/607; D3/287; D3/289**

(58) **Field of Search** ..... **D7/605-608; D3/273,**  
**D3/276.283, 287, 289; 190/110; 220/592.2,**  
**592.24, 592.25, 915.1, 915.2; 62/457.1,**  
**457.7, 371, 372; 383/97, 110**

(56) **References Cited**

**U.S. PATENT DOCUMENTS**

4,537,313 A \* 8/1985 Workman ..... 62/457.1 X  
4,620,579 A \* 11/1986 Lowe et al. .... 190/110 X  
4,805,776 A \* 2/1989 Namgyal et al. .... 383/110

D340,840 S \* 11/1993 Melk ..... D7/607

D371,052 S \* 6/1996 Melk ..... D7/607

D371,942 S \* 7/1996 Lippincott et al. .... D7/607

D412,269 S \* 7/1999 Wyant ..... D7/607 X

\* cited by examiner

*Primary Examiner*—Terry A. Wallace

(74) *Attorney, Agent, or Firm*—Birch, Stewart, Kolasch &  
Birch, LLP

(57) **CLAIM**

The ornamental design for a cooler, substantially as shown  
and described.

**DESCRIPTION**

FIG. 1 is a front elevational view of the deep emboss cooler  
bag;

FIG. 2 is a rear elevational view thereof;

FIG. 3 is a top plan view thereof;

FIG. 4 is a bottom plan view thereof;

FIG. 5 is a left side elevational view thereof; and,

FIG. 6 is a right side elevational view thereof.

**1 Claim, 3 Drawing Sheets**

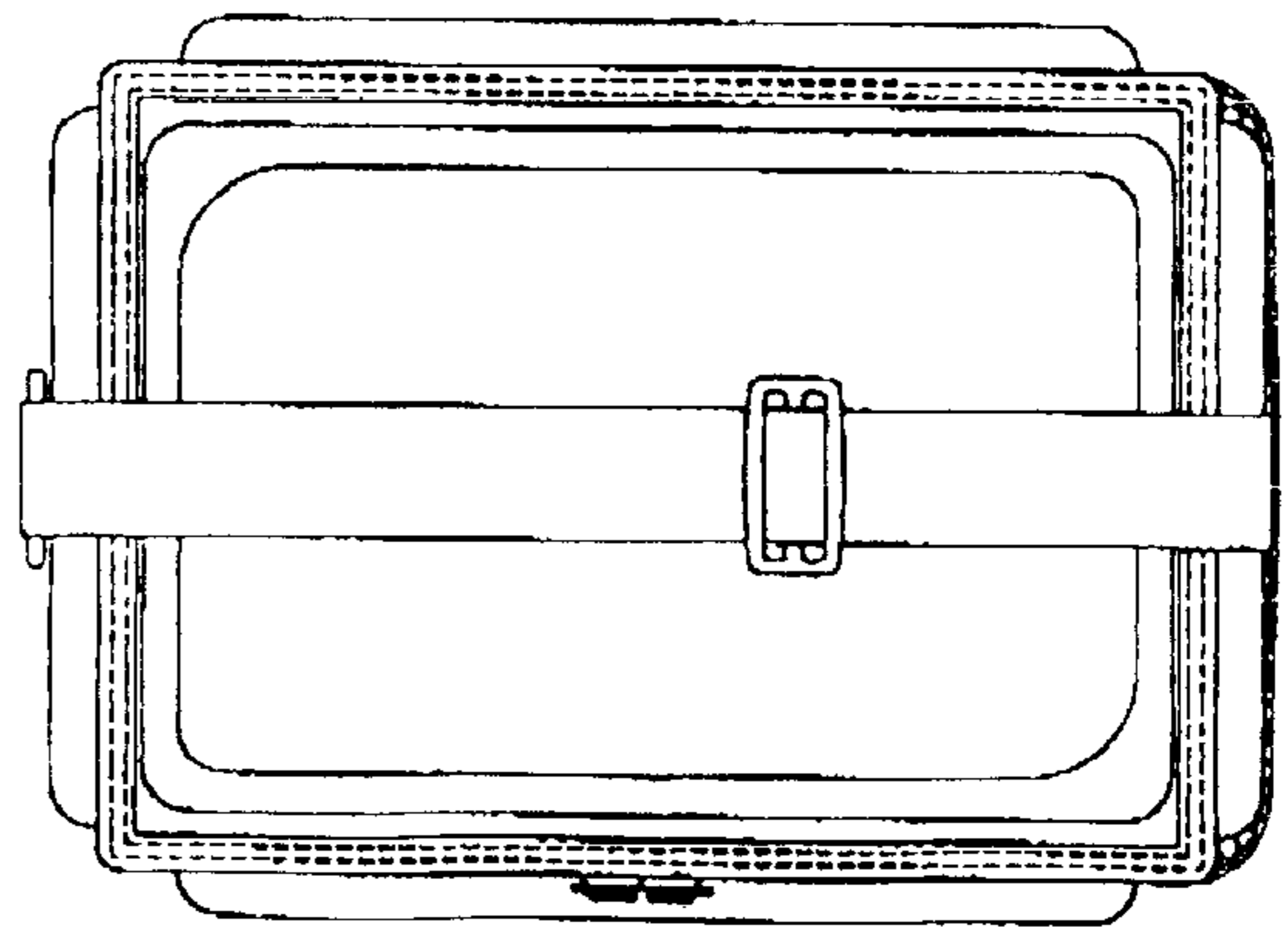
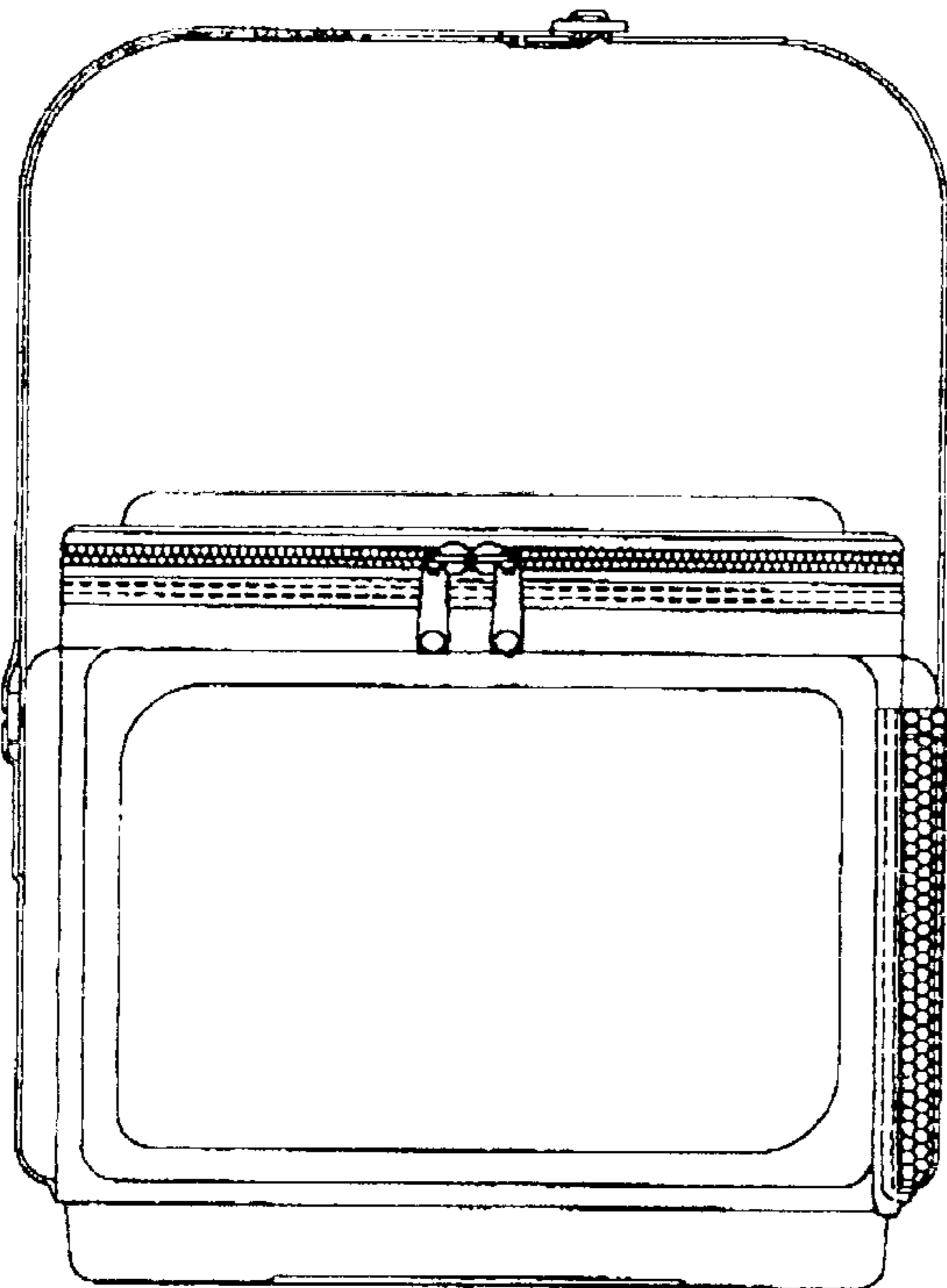

**FIG. 1**

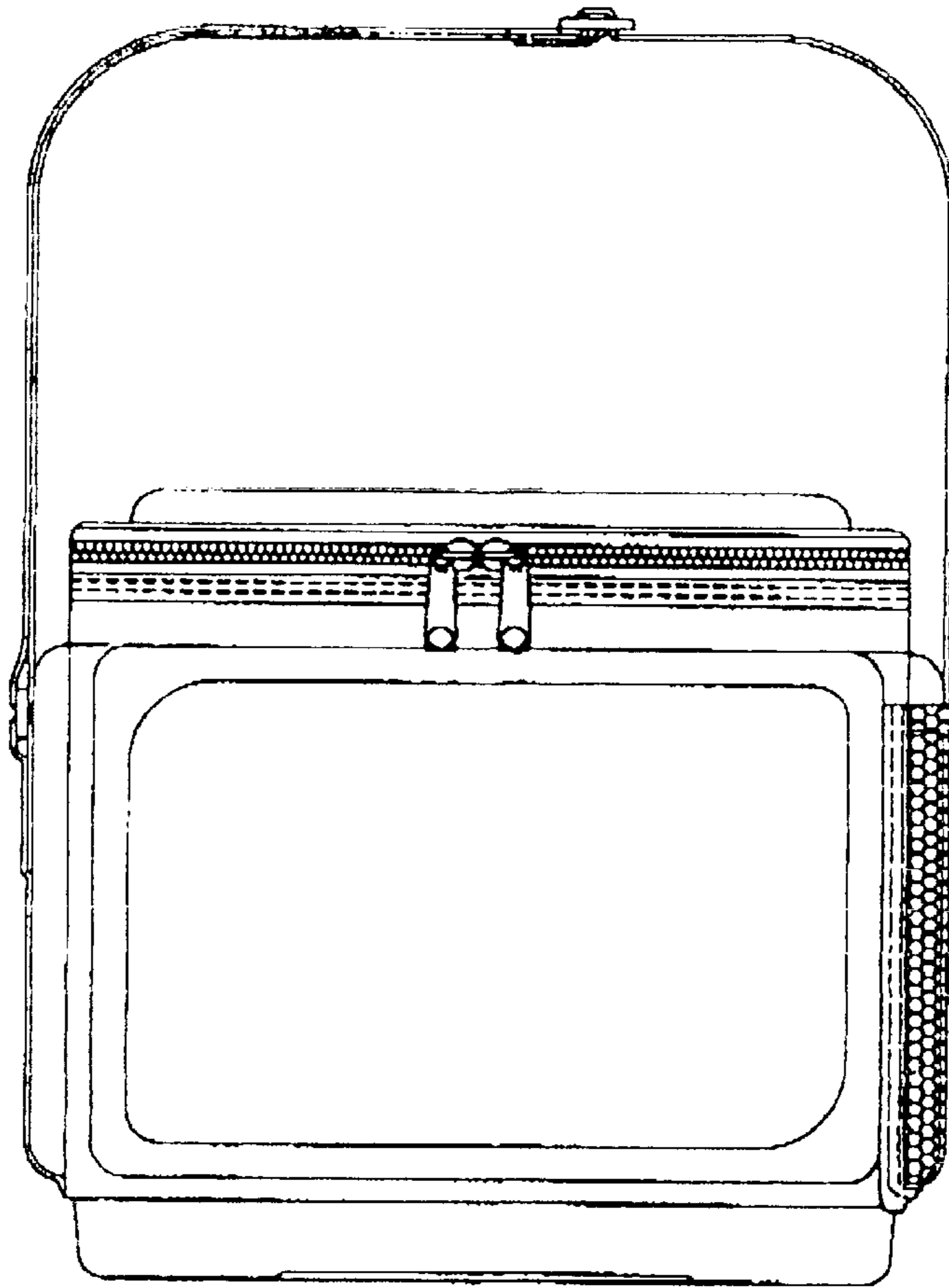

**FIG. 3**

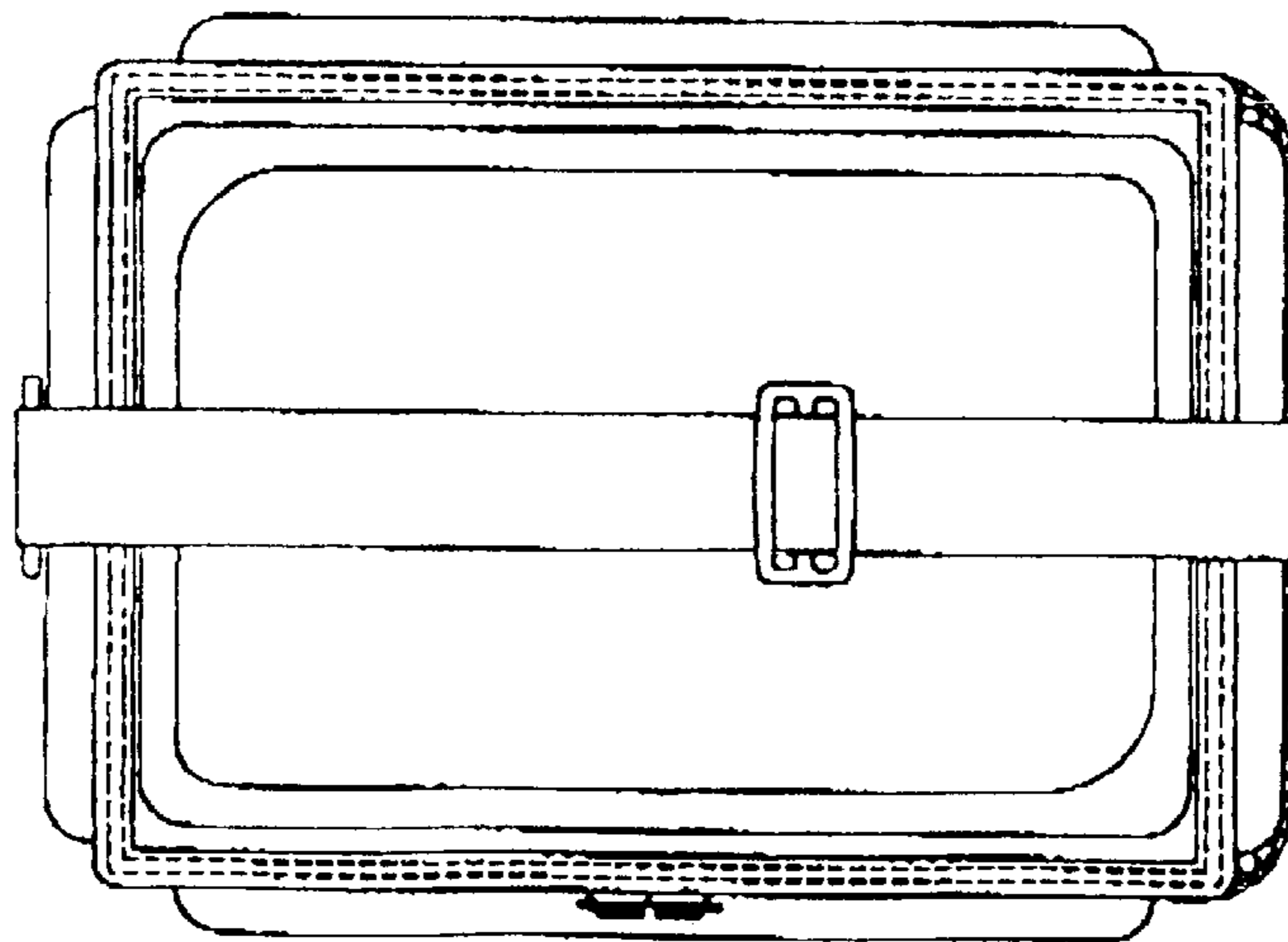

**FIG. 2**

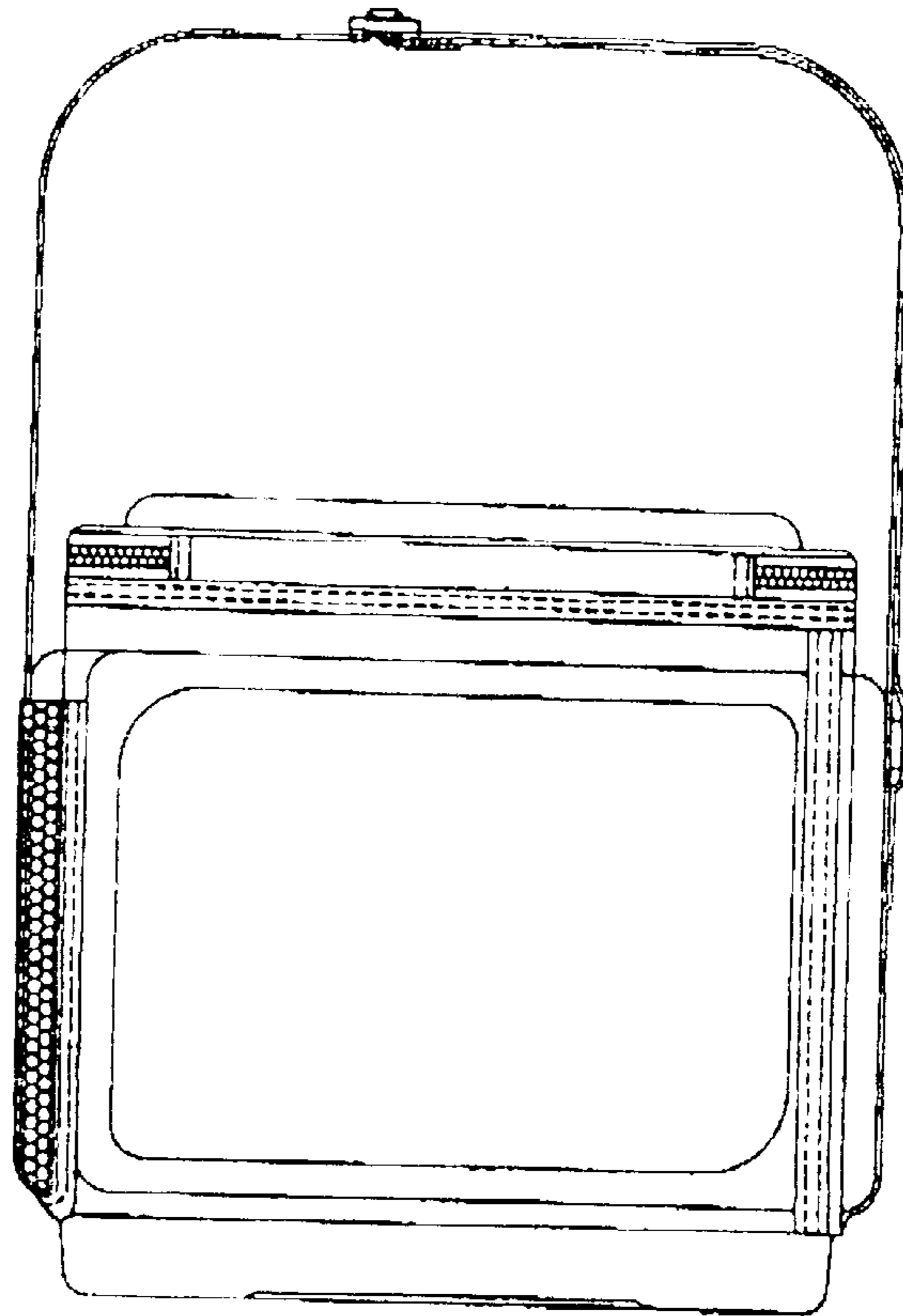

**FIG. 4**

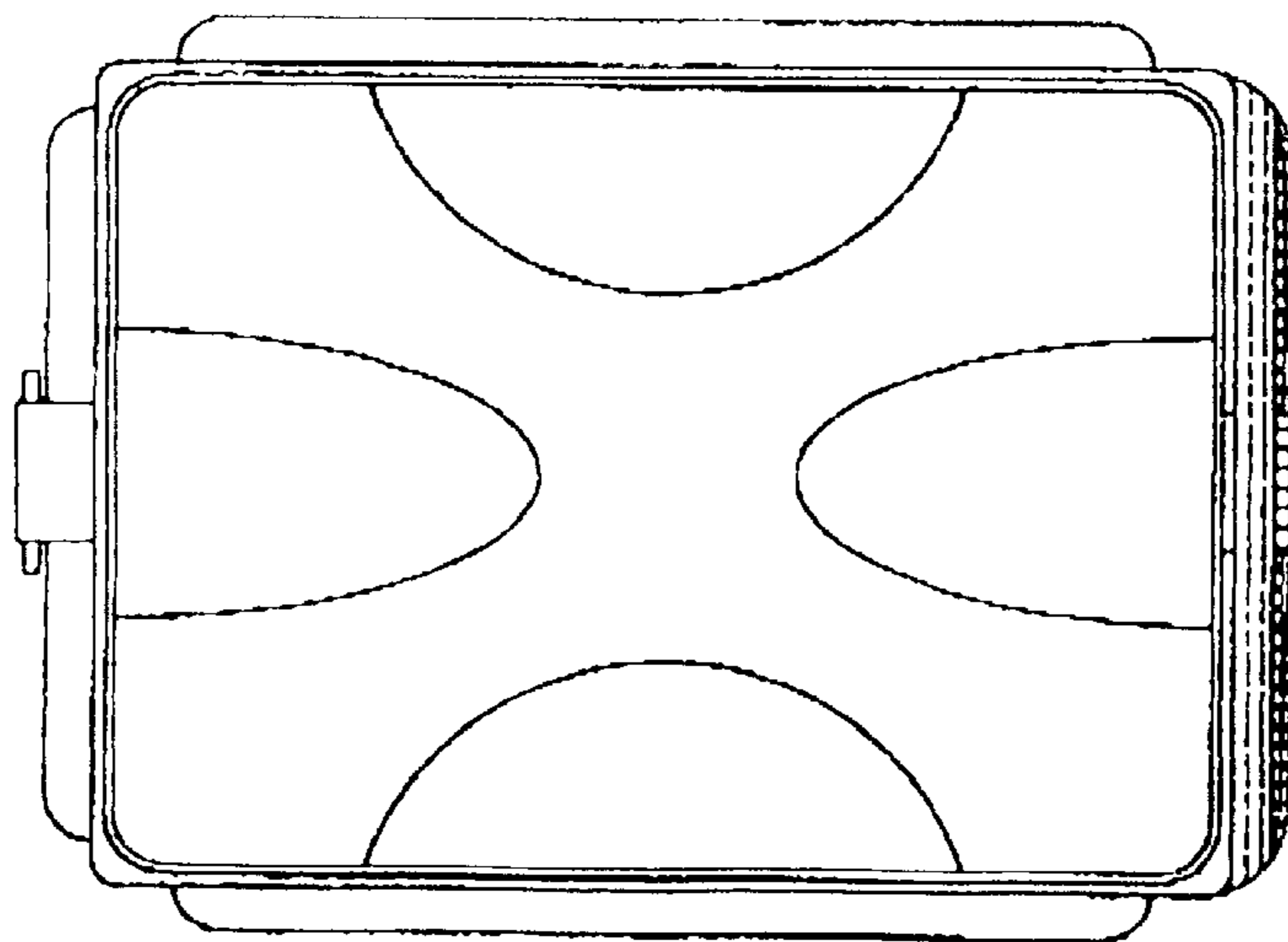

**FIG. 5**

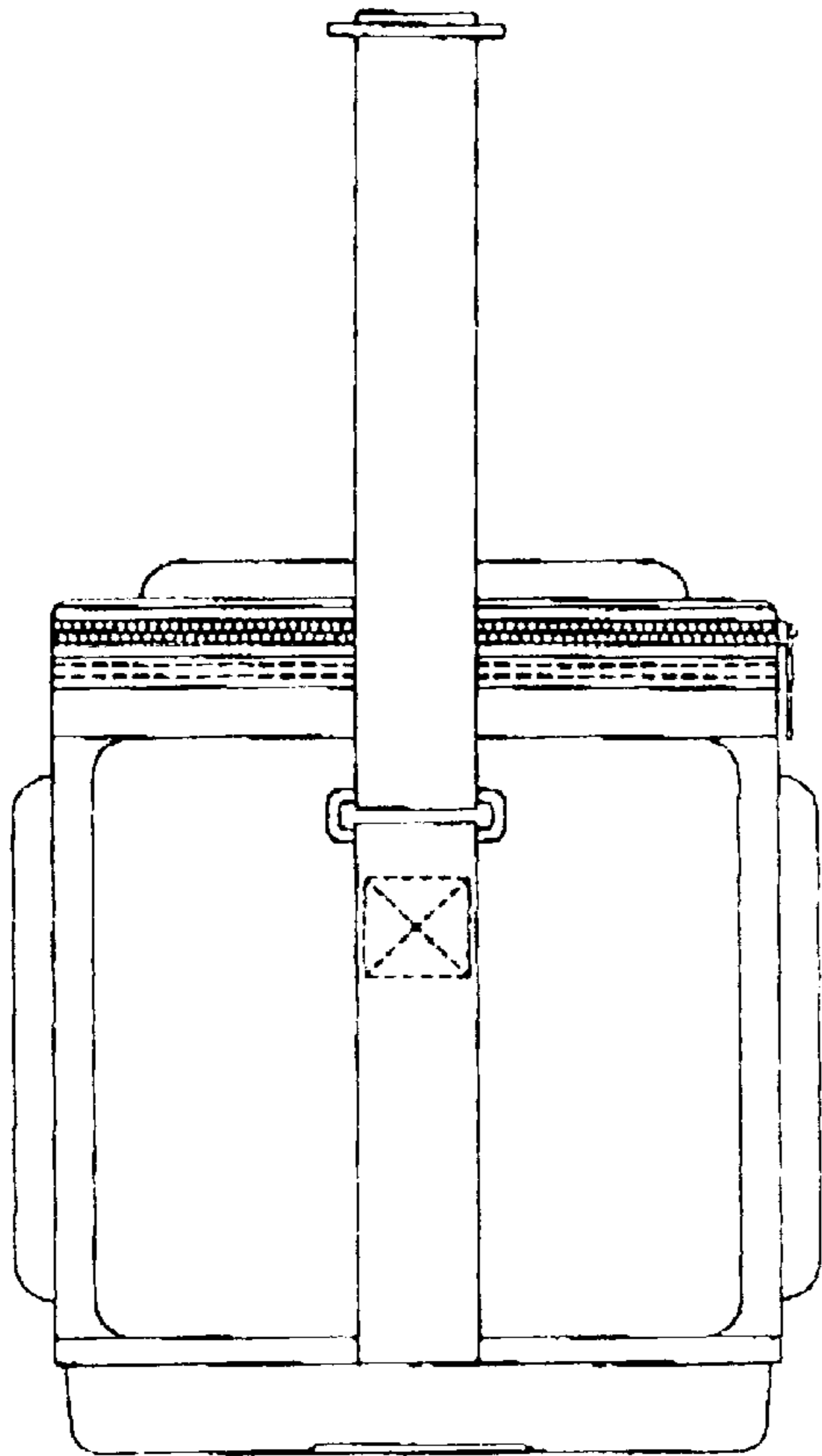

**FIG. 6**

