



US00D464222S

(12) **United States Design Patent**
Coffin et al.

(10) **Patent No.:** **US D464,222 S**

(45) **Date of Patent:** **** Oct. 15, 2002**

(54) **RAZOR HOLDER**

D440,799 S * 4/2001 Christianson D6/528

(75) Inventors: **David Charles Coffin**, Milford, CT
(US); **David Dombrowski**, Milford, CT
(US)

* cited by examiner

Primary Examiner—Brian N. Vinson

(74) *Attorney, Agent, or Firm*—Peter C. Richardson; Gregg
C. Benson; Raymond D. Thompson

(73) Assignee: **Warner-Lambert Company**, Morris
Plains, NJ (US)

(57) **CLAIM**

(**) Term: **14 Years**

The ornamental design for a razor holder, as shown and
described.

(21) Appl. No.: **29/145,459**

DESCRIPTION

(22) Filed: **Jul. 24, 2001**

(51) **LOC (7) Cl.** **28-03**

(52) **U.S. Cl.** **D6/526**

(58) **Field of Search** D6/526; 206/349,
206/351–360; 211/13.1, 70.6, 86.01, 87.01,
88.01; 248/309.1

FIG. 1 is a top, front, perspective view, with certain elements
not being claimed shown in broken line, showing my new
design,

FIG. 2 is a bottom, front perspective view thereof,

FIG. 3 is a right hand side view thereof,

FIG. 4 is a left hand side view thereof,

FIG. 5 is a front elevational view thereof,

FIG. 6 is a rear elevational view thereof,

FIG. 7 is a top elevational view thereof; and,

FIG. 8 is a bottom elevational view thereof.

(56) **References Cited**

U.S. PATENT DOCUMENTS

D370,375 S * 6/1996 Murgida et al. D6/526
D423,845 S * 5/2000 Coffin et al. D6/526

1 Claim, 3 Drawing Sheets

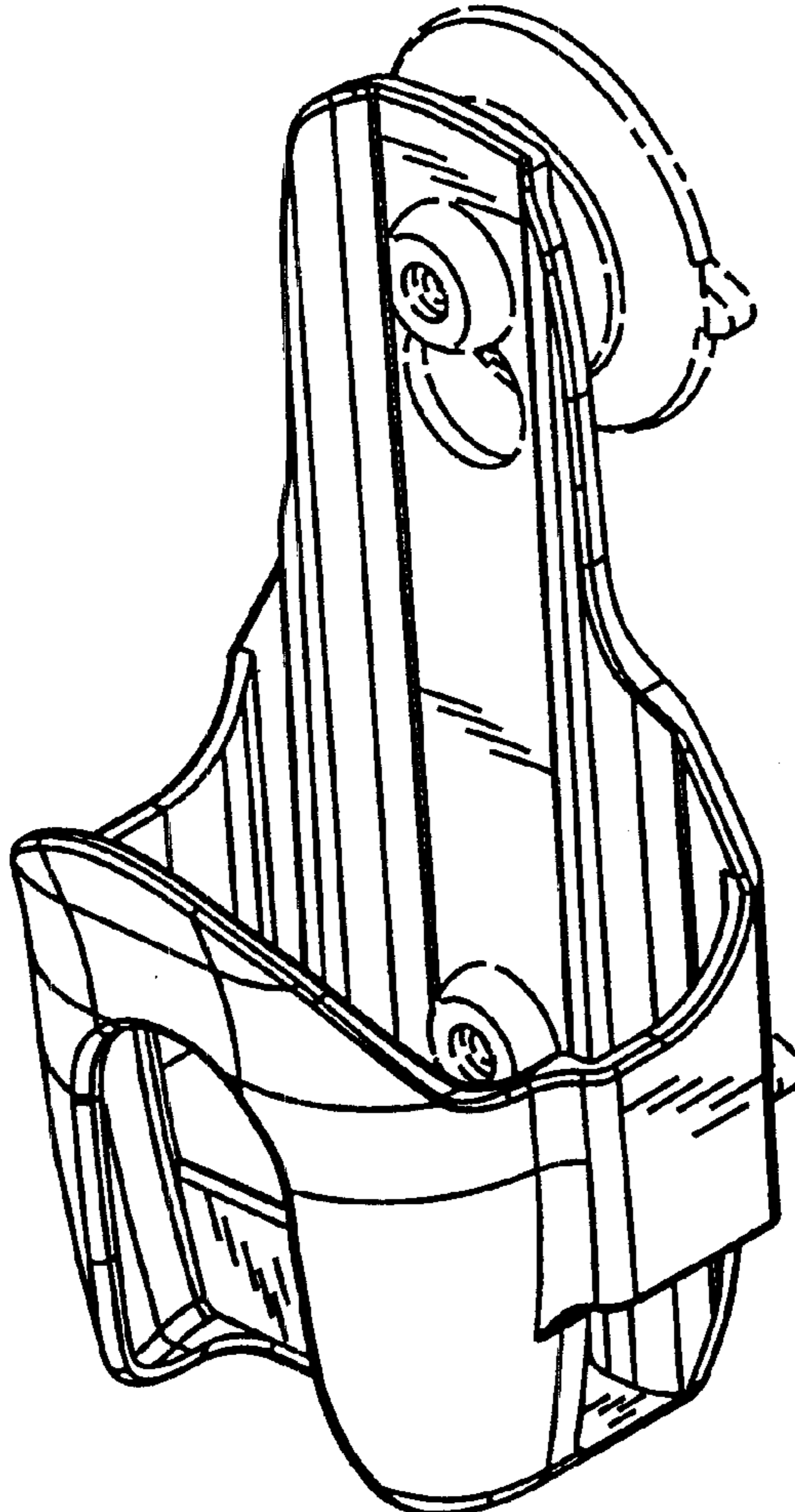

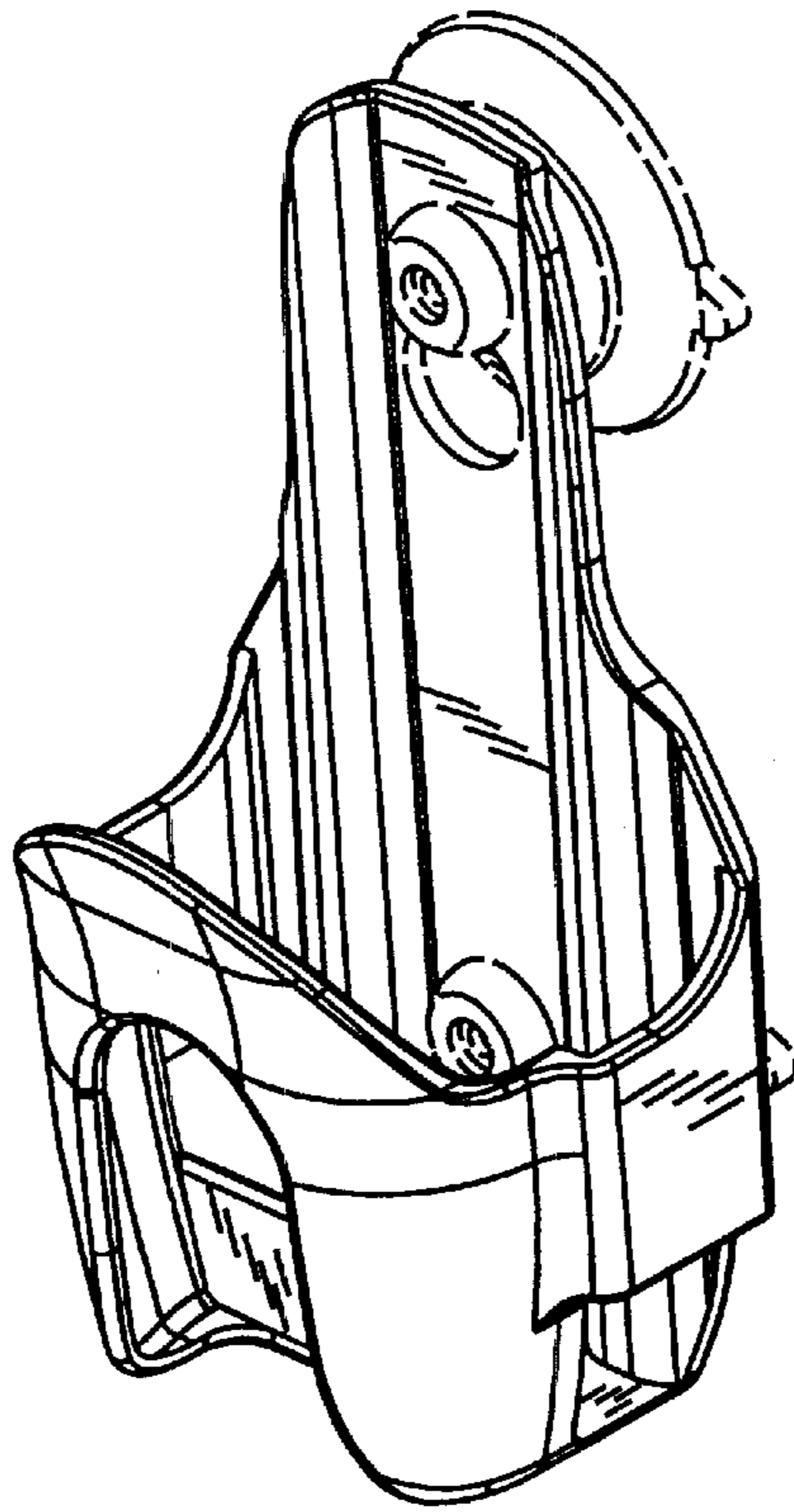

FIG. 1

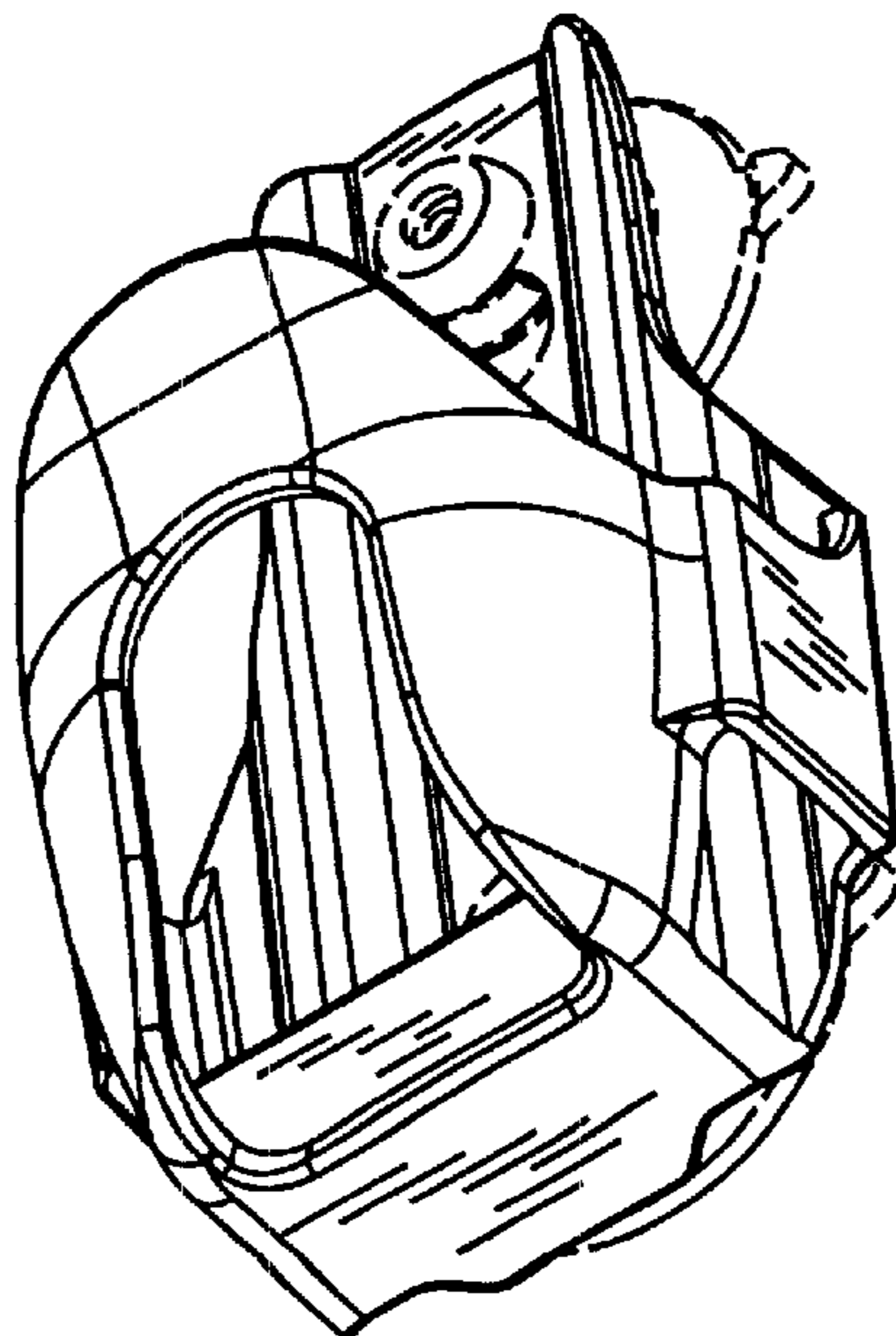

FIG. 2

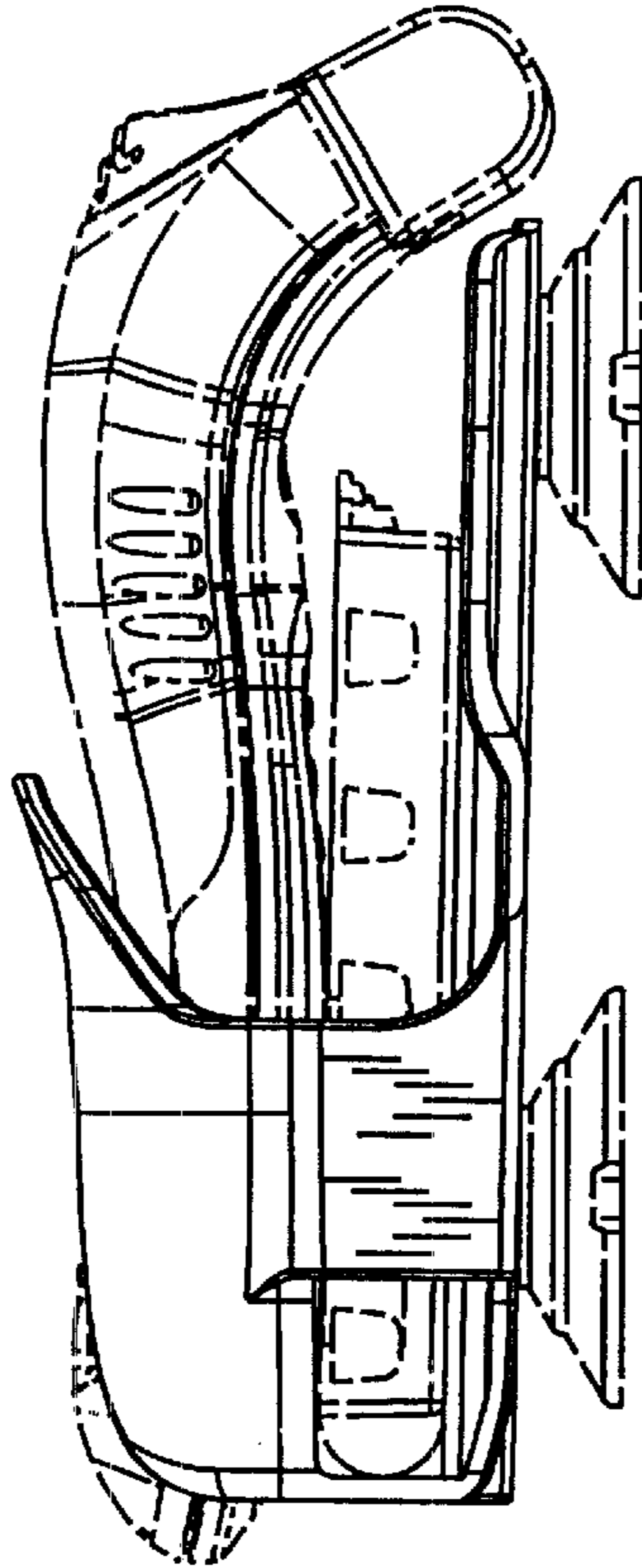

FIG. 3

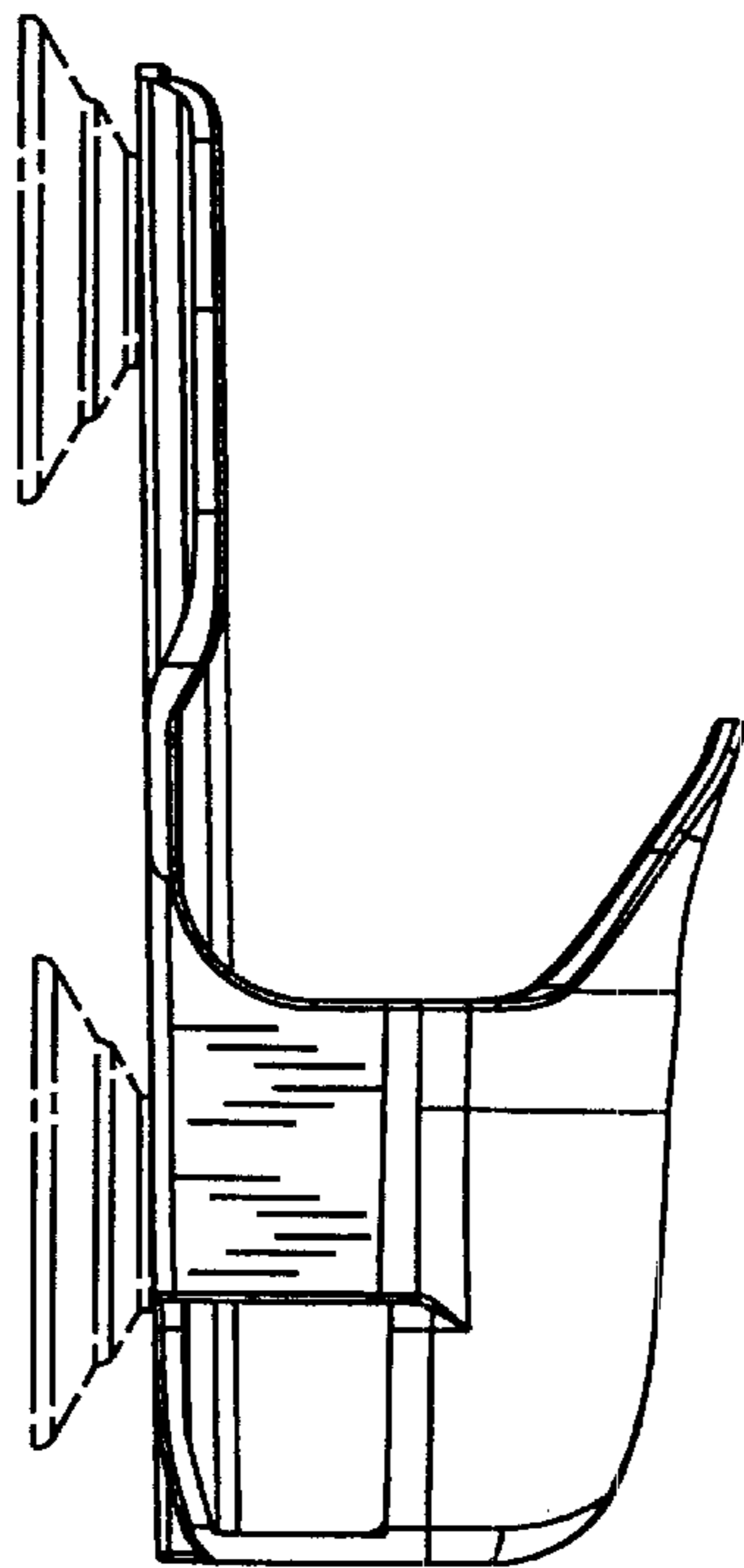

FIG. 4

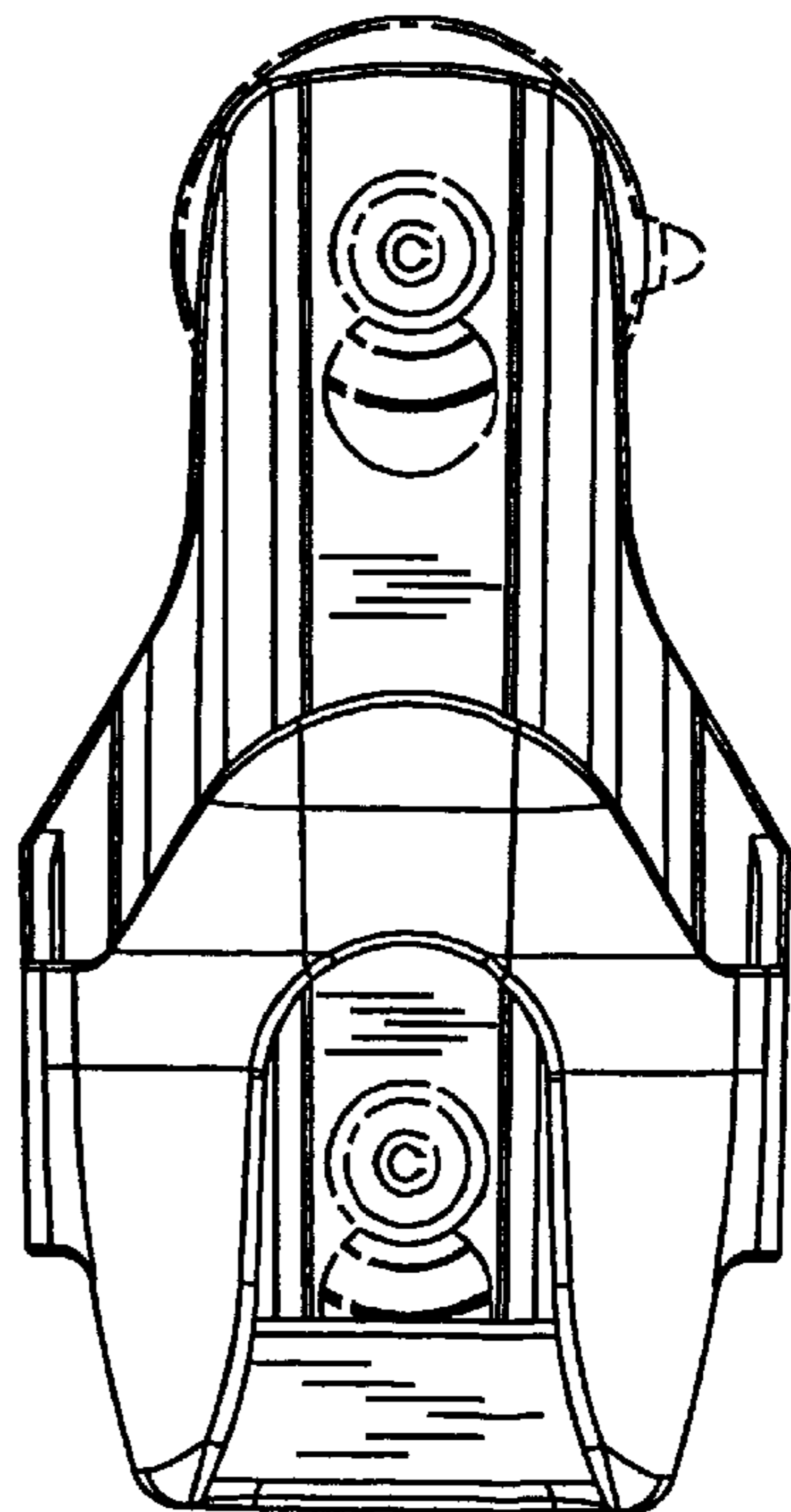

FIG. 5

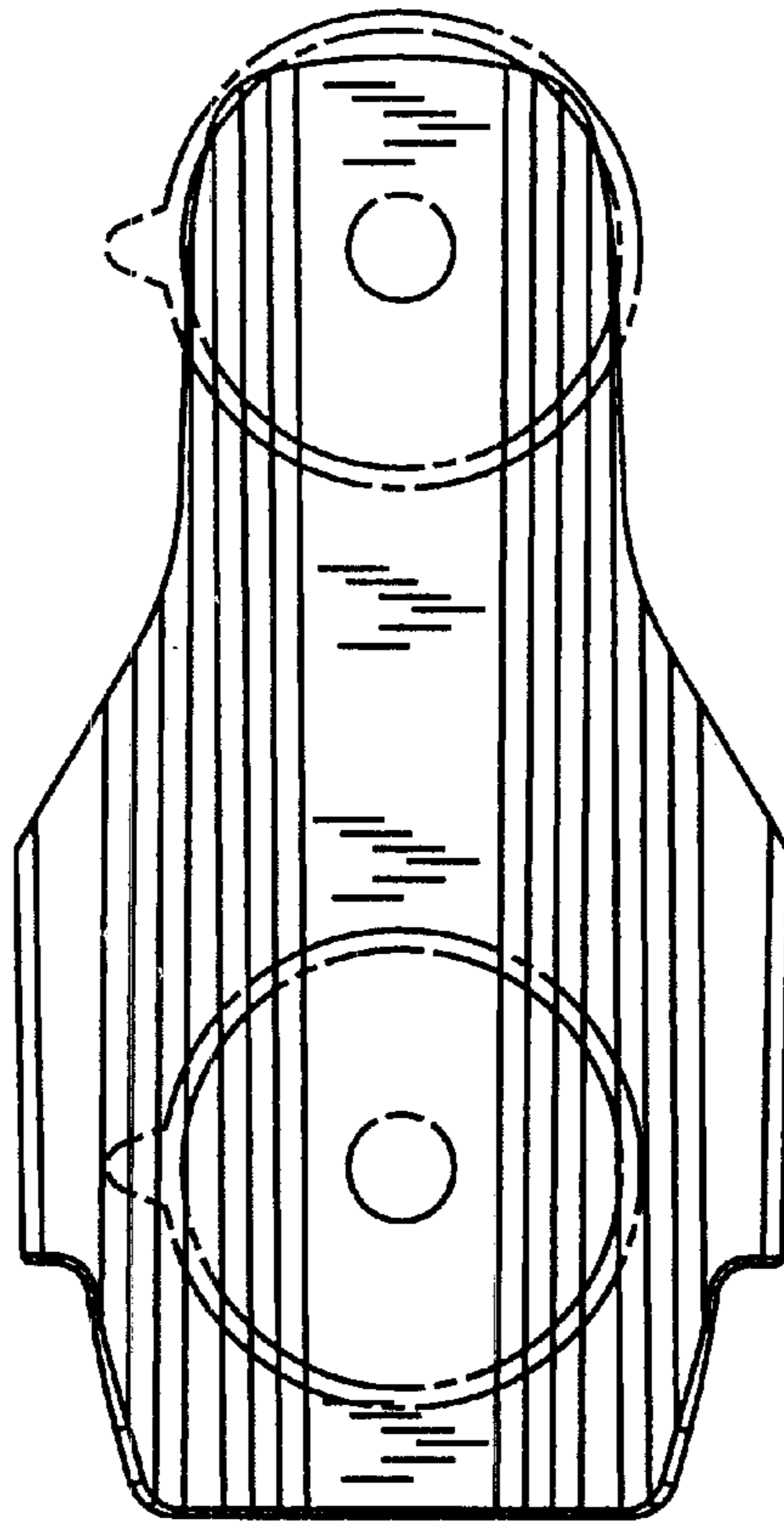

FIG. 6

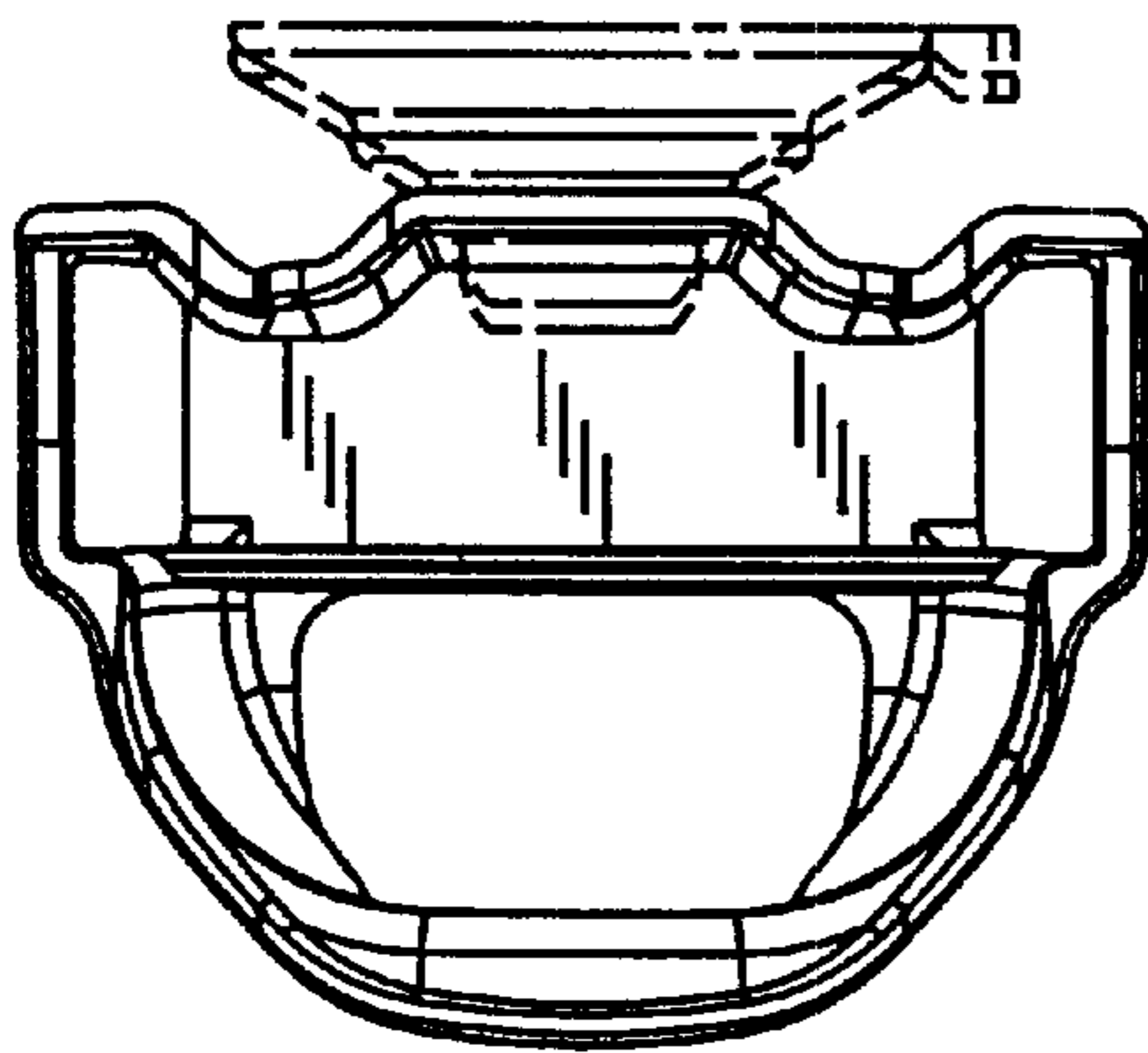

FIG. 7

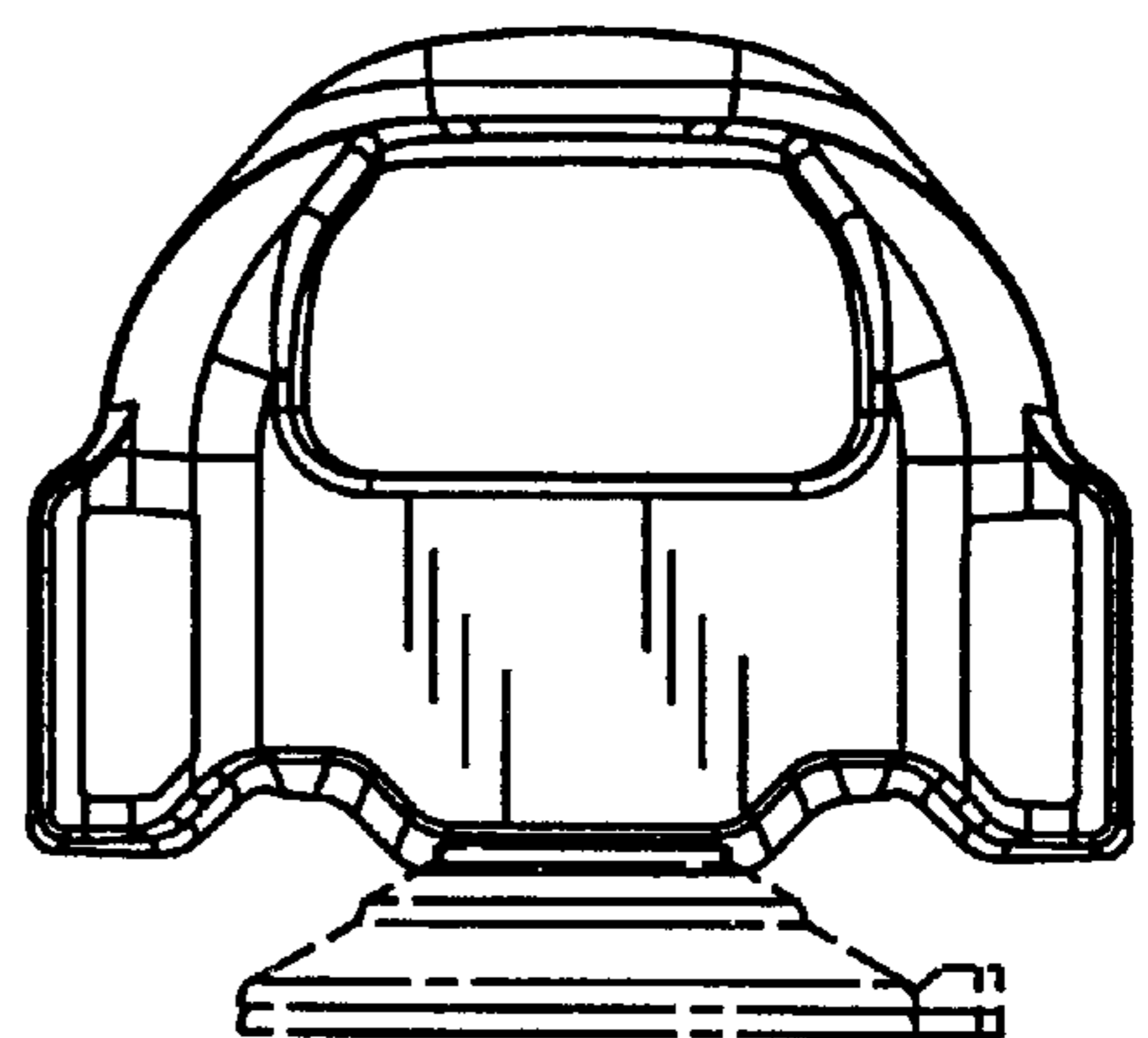

FIG. 8