



US00D464220S

(12) **United States Design Patent**
Hartenstine et al.

(10) **Patent No.:** **US D464,220 S**

(45) **Date of Patent:** **** Oct. 15, 2002**

(54) **END TOP FOR USE WITH A PLAYARD**

(75) Inventors: **Curtis M. Hartenstine**, Birdsboro, PA (US); **Michael L. Longenecker**, Ephrata, PA (US)

(73) Assignee: **Graco Children's Products Inc.**, Elverson, PA (US)

(**) Term: **14 Years**

(21) Appl. No.: **29/155,866**

(22) Filed: **Feb. 21, 2002**

D362,984 S	10/1995	Brunner et al.	
D364,754 S	12/1995	Welsh, Jr. et al.	
D369,490 S	5/1996	Brunner et al.	
D379,128 S	5/1997	Brunner et al.	
D380,918 S	7/1997	Brunner et al.	
D394,768 S	6/1998	Draheim	
D395,565 S	6/1998	Brunner et al.	
D409,025 S	5/1999	Draheim et al.	
D410,161 S	5/1999	Draheim et al.	
D410,162 S	5/1999	Draheim et al.	
D418,995 S	* 1/2000	Blumenthal	D6/385
D440,439 S	* 4/2001	Zaidman	D6/503
D448,218 S	9/2001	Celestina-Krevh	

* cited by examiner

Related U.S. Application Data

(62) Division of application No. 29/141,547, filed on May 9, 2001.

(51) **LOC (7) Cl.** **06-06**

(52) **U.S. Cl.** **D6/505**

(58) **Field of Search** D6/390, 393, 391, D6/333, 331, 503, 491, 505-508; 5/53.1, 907, 279.1, 280, 281, 93.1, 93.2, 98.1, 100, 101

References Cited

U.S. PATENT DOCUMENTS

4,739,527 A	4/1988	Kohus et al.	
D323,589 S	2/1992	Mariol	
D329,955 S	10/1992	Brunner et al.	
D335,057 S	4/1993	Brunner et al.	
D346,927 S	5/1994	Brunner et al.	
D349,199 S	* 8/1994	Woodhams	D6/393
D353,274 S	12/1994	Schwartzkopf	
D353,725 S	12/1994	Brunner et al.	

Primary Examiner—Janice E. Seeger

(74) *Attorney, Agent, or Firm*—Foley & Lardner

(57) **CLAIM**

The ornamental design for an end top for use with a playard, as shown and described.

DESCRIPTION

FIG. 1 is a perspective view of the end top for use with a playard of our new design mounted to a playard; FIG. 2 is a perspective view of the end top; FIG. 3 is a front elevation view thereof; FIG. 4 is a rear elevation view thereof; FIG. 5 is a top plan view thereof; FIG. 6 is a right side elevation view thereof, the left side elevation view being a mirror image of the right side elevation view; and, FIG. 7 is a bottom plan view thereof.

The broken lines are for illustrative purposes only and do not form part of the claimed design.

1 Claim, 4 Drawing Sheets

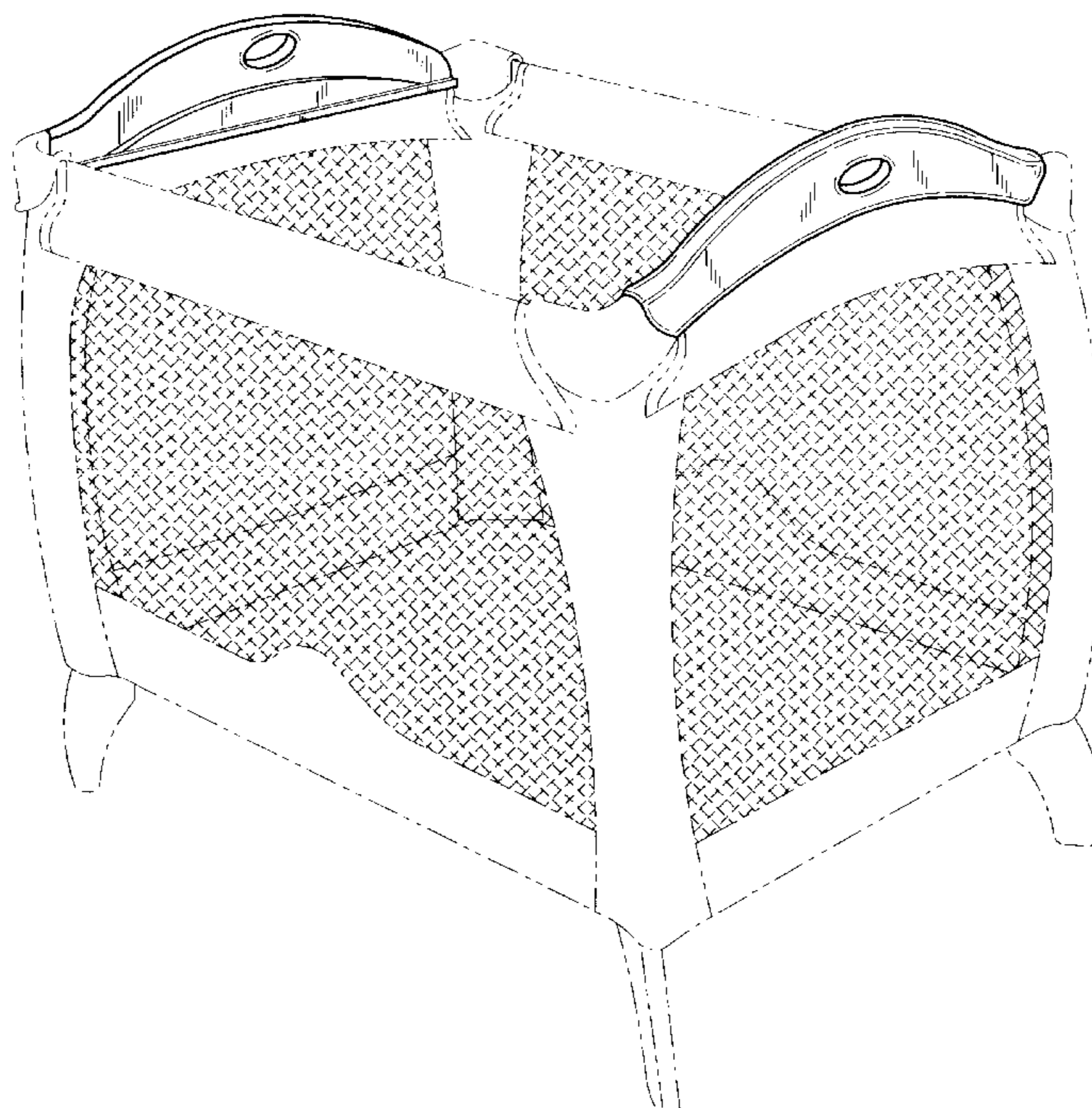

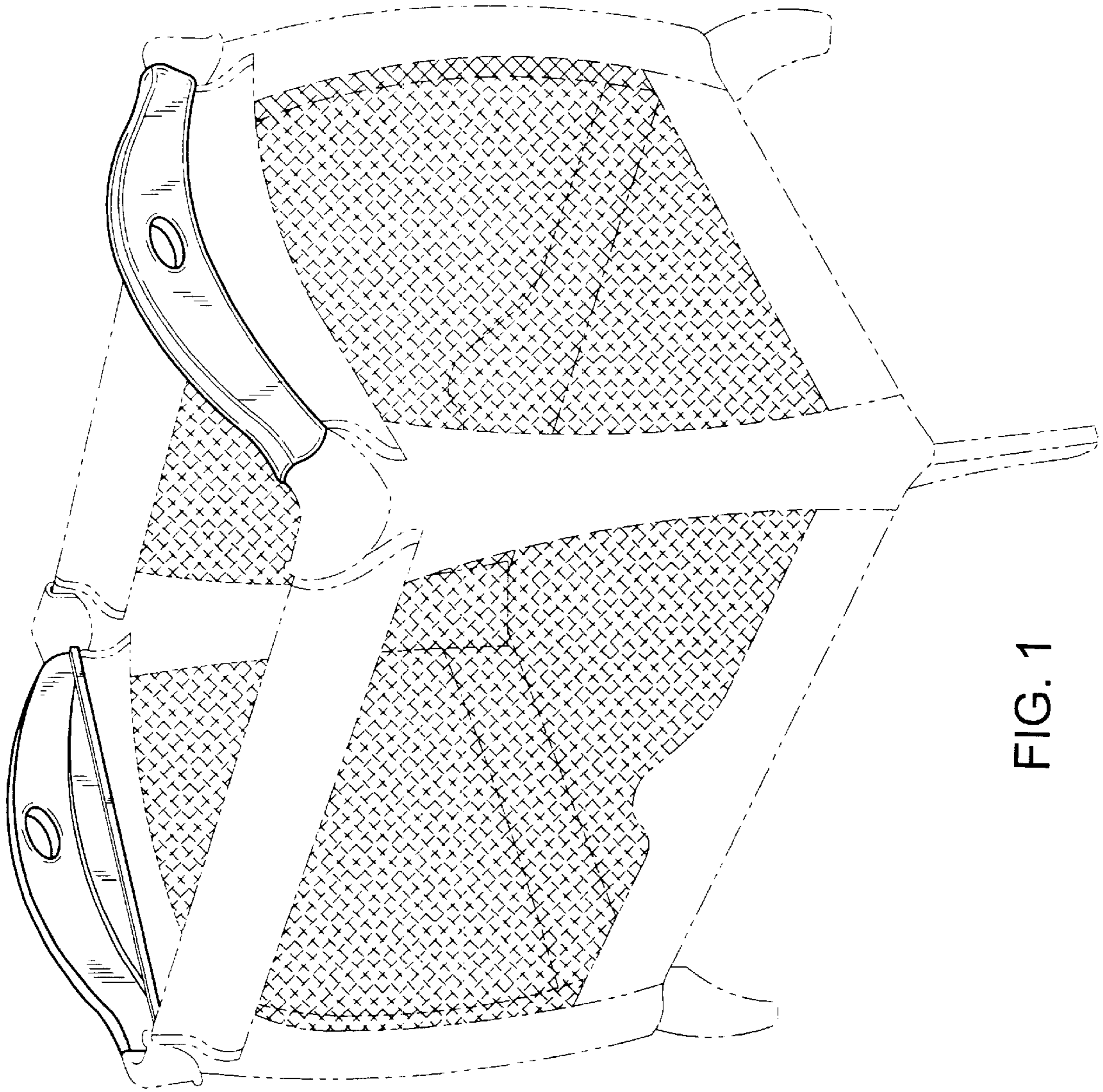
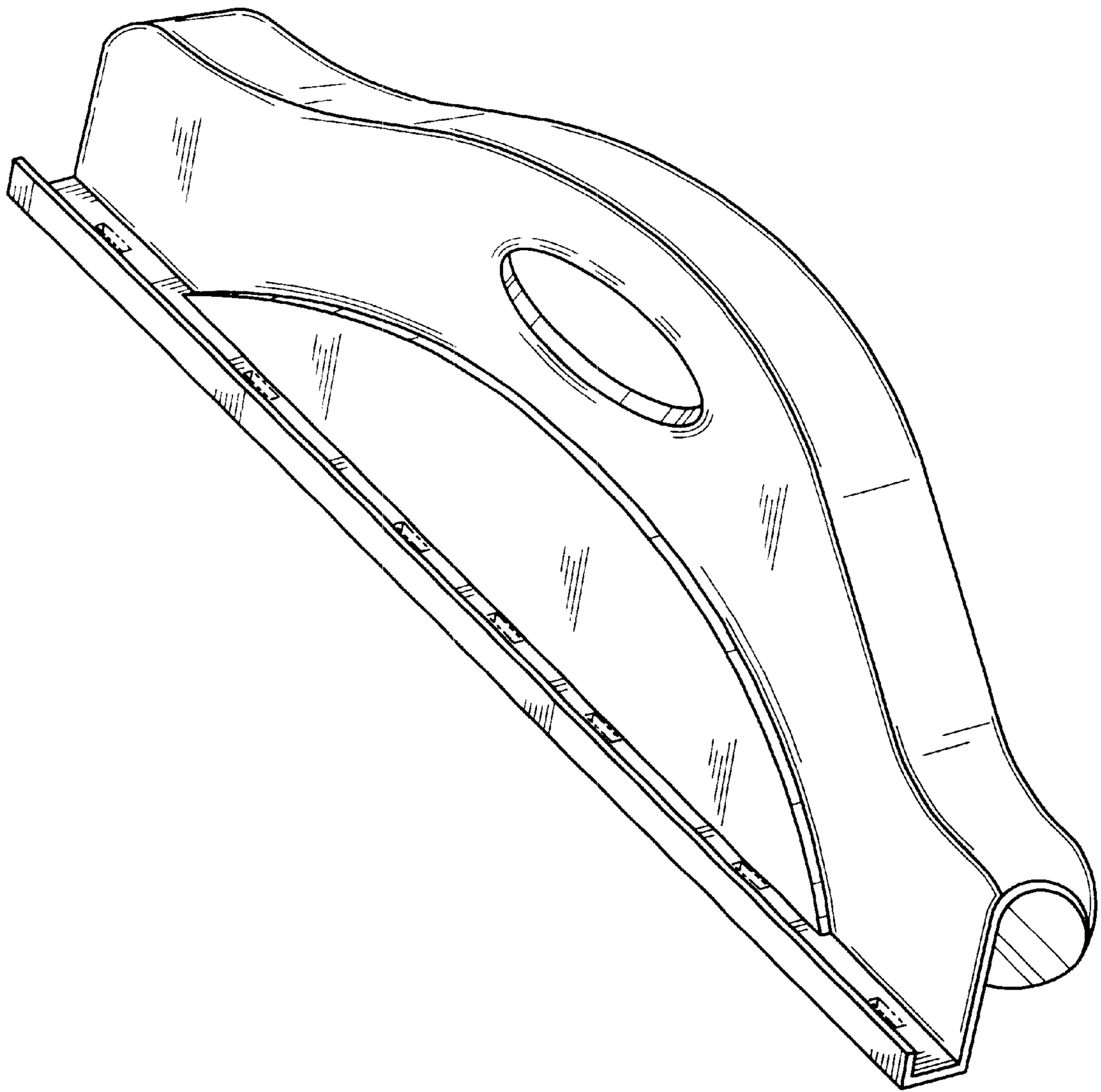

FIG. 1

FIG. 2



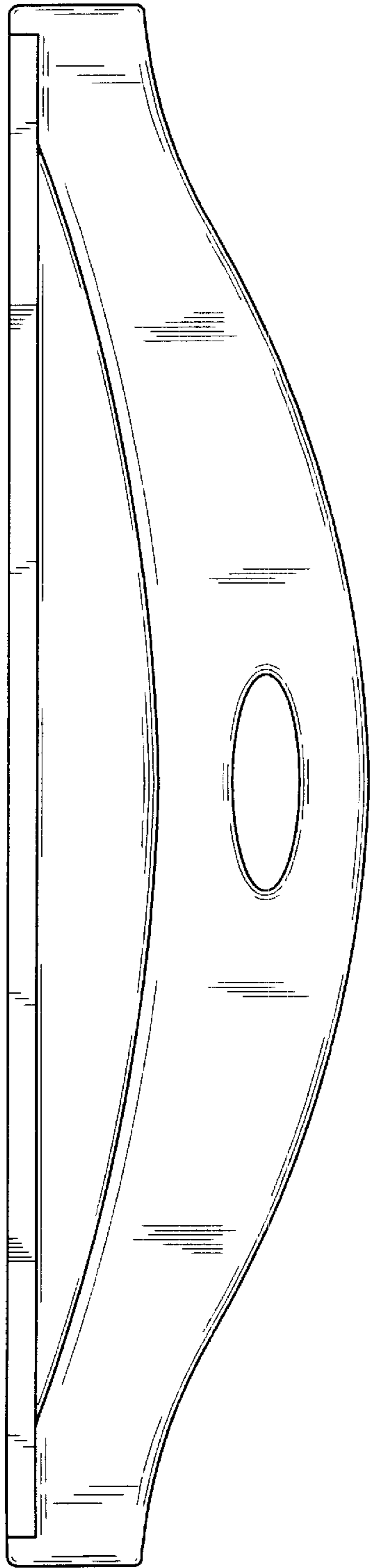

FIG. 3

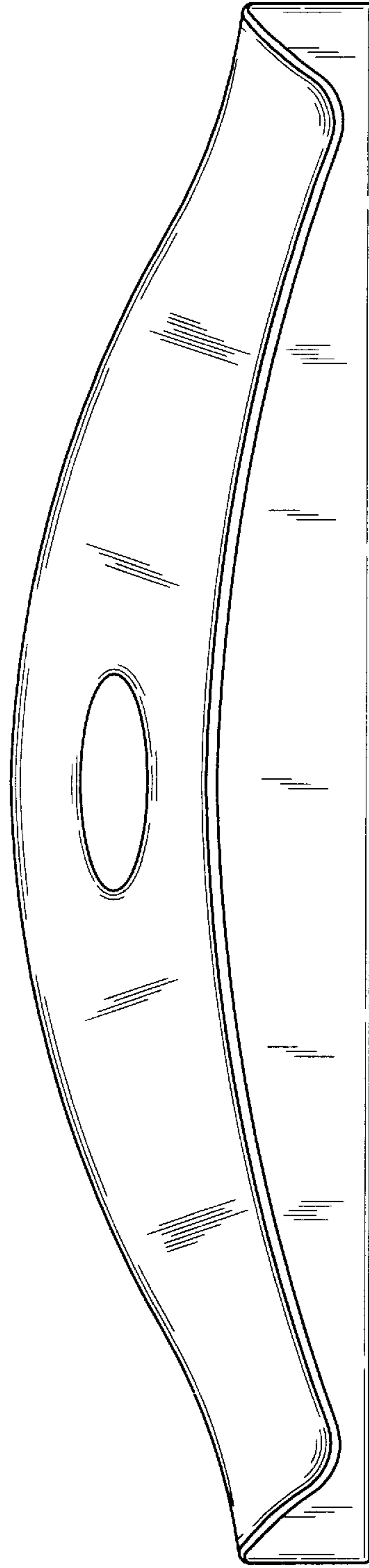

FIG. 4

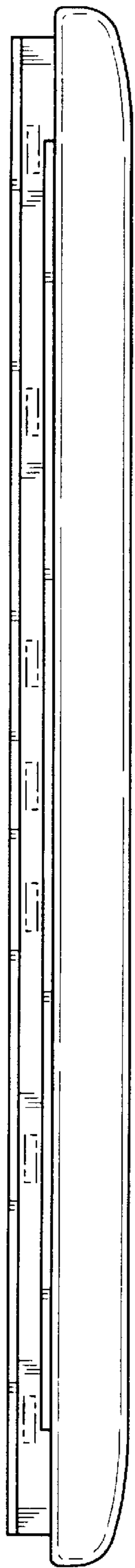

FIG. 5

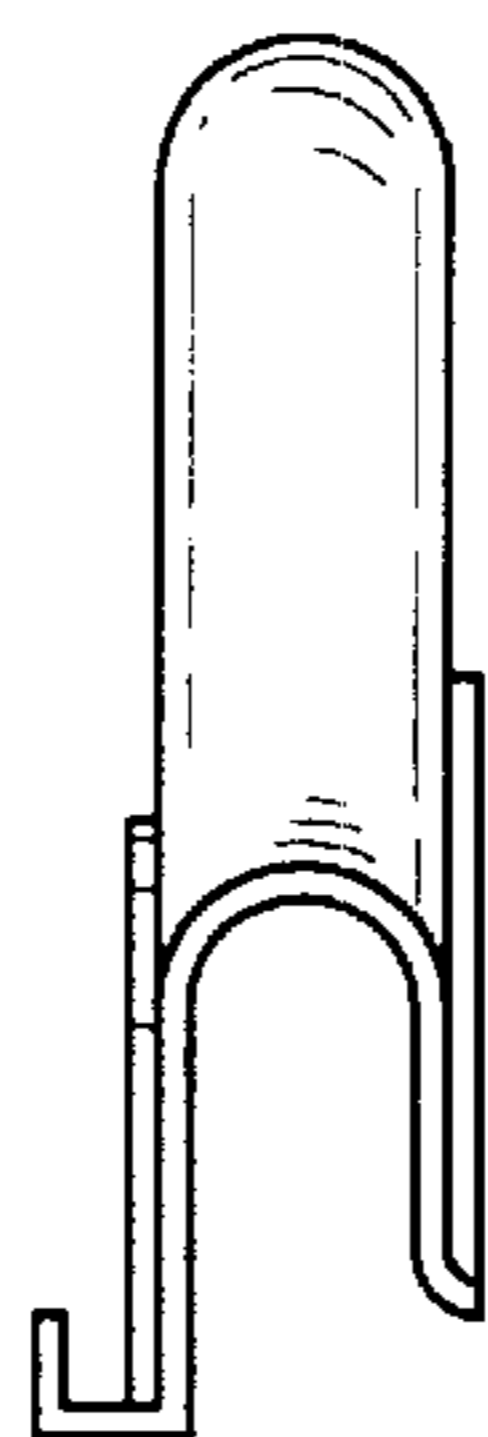

FIG. 6

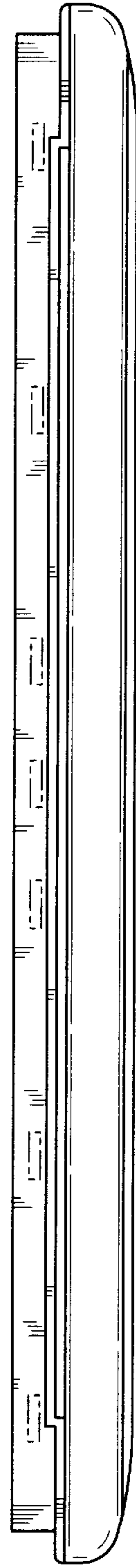

FIG. 7