



US00D464185S

(12) **United States Design Patent**
Olson

(10) **Patent No.:** **US D464,185 S**

(45) **Date of Patent:** **** Oct. 8, 2002**

(54) **HOUSEKEEPING CART**

(75) Inventor: **Jeffrey C. Olson**, Dallas, PA (US)

(73) Assignee: **Metro Industries, Inc.**, Reno, NV (US)

(**) Term: **14 Years**

(21) Appl. No.: **29/147,448**

(22) Filed: **Aug. 30, 2001**

(51) **LOC (7) Cl.** **12-02**

(52) **U.S. Cl.** **D34/21; D34/20**

(58) **Field of Search** **D34/12-27; 280/79.11,**
280/79.2, 79.3, 47.19, 47.34, 47.35; 296/22;
108/59; 312/250

(56) **References Cited**

U.S. PATENT DOCUMENTS

D302,064 S	*	7/1989	Delmerico	D34/20
D371,880 S	*	7/1996	Mestropian	D34/21
D374,532 S	*	10/1996	Pool	D34/21

* cited by examiner

Primary Examiner—**Kay H. Chin**

(74) *Attorney, Agent, or Firm*—**Fitzpatrick, Cella, Harper & Scinto**

(57) **CLAIM**

The ornamental design for a housekeeping cart, as shown and described.

DESCRIPTION

FIG. 1 is a perspective view of the front of a housekeeping cart with the wheels, wire holders on the left side, bottom

shelf, and embossed surface features being shown in phantom (broken lines);

FIG. 2 is a perspective view of the back of the housekeeping cart shown in FIG. 1;

FIG. 3 is a front view of the housekeeping cart shown in FIG. 1;

FIG. 4 is a rear view of the housekeeping cart shown in FIG. 1;

FIG. 5 is a side view of the right side of the housekeeping cart shown in FIG. 1;

FIG. 6 is a side view of the left side of the housekeeping cart shown in FIG. 1;

FIG. 7 is a top view of the housekeeping cart shown in FIG. 1;

FIG. 8 is a perspective view of a second embodiment of the housekeeping cart with the wheels, wire holder on the right side, and embossed surface features being shown in phantom (broken lines);

FIG. 9 is a perspective view of the back of the housekeeping cart shown in FIG. 8;

FIG. 10 is a front view of the housekeeping cart shown in FIG. 8;

FIG. 11 is a rear view of the housekeeping cart shown in FIG. 8;

FIG. 12 is a side view of the right side of the housekeeping cart shown in FIG. 8;

FIG. 13 is a side view of the left side of the housekeeping cart shown in FIG. 8; and,

FIG. 14 is a top view of the housekeeping cart shown in FIG. 8.

In each of the figures, the broken lines illustrate features not claimed.

1 Claim, 14 Drawing Sheets

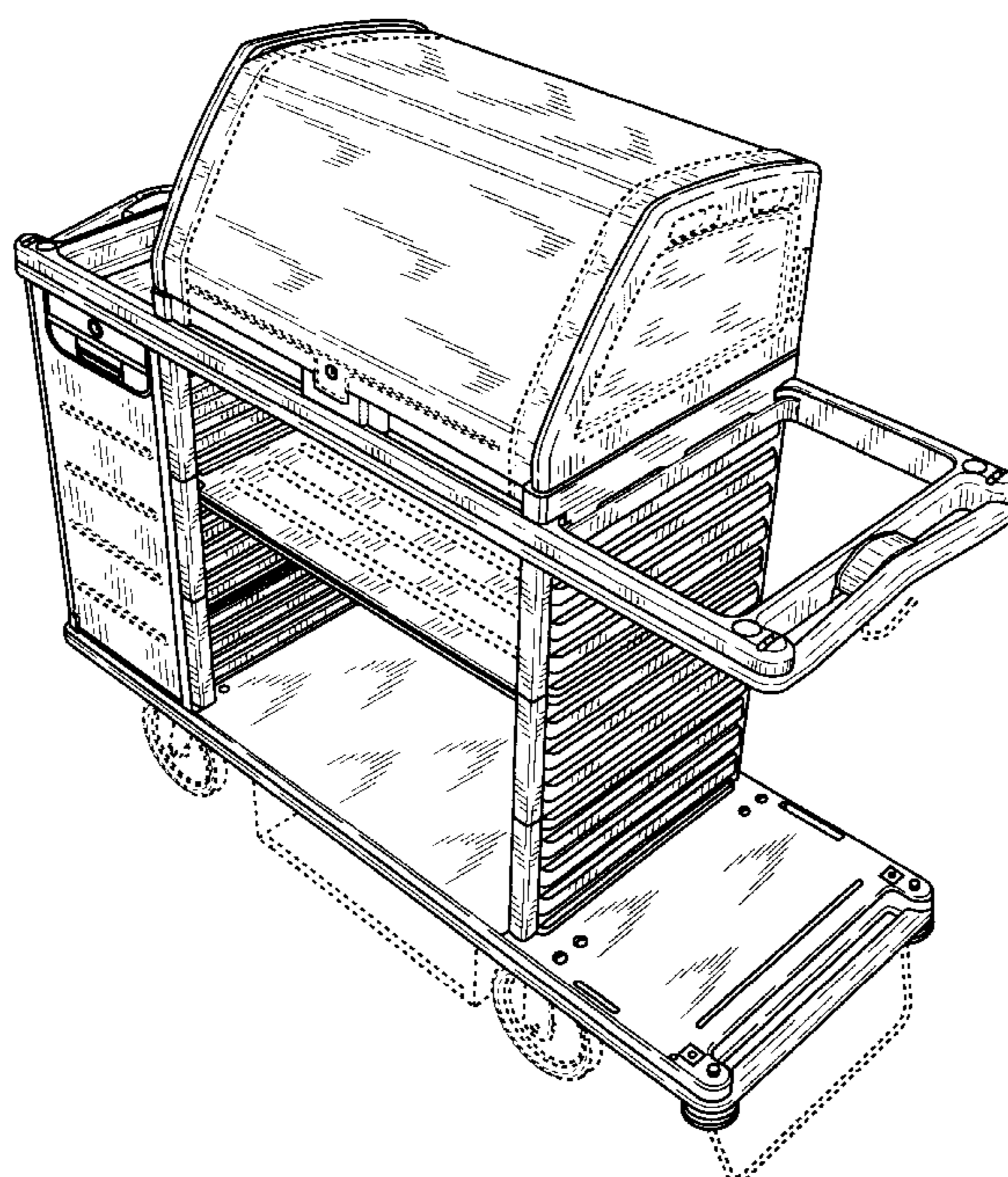

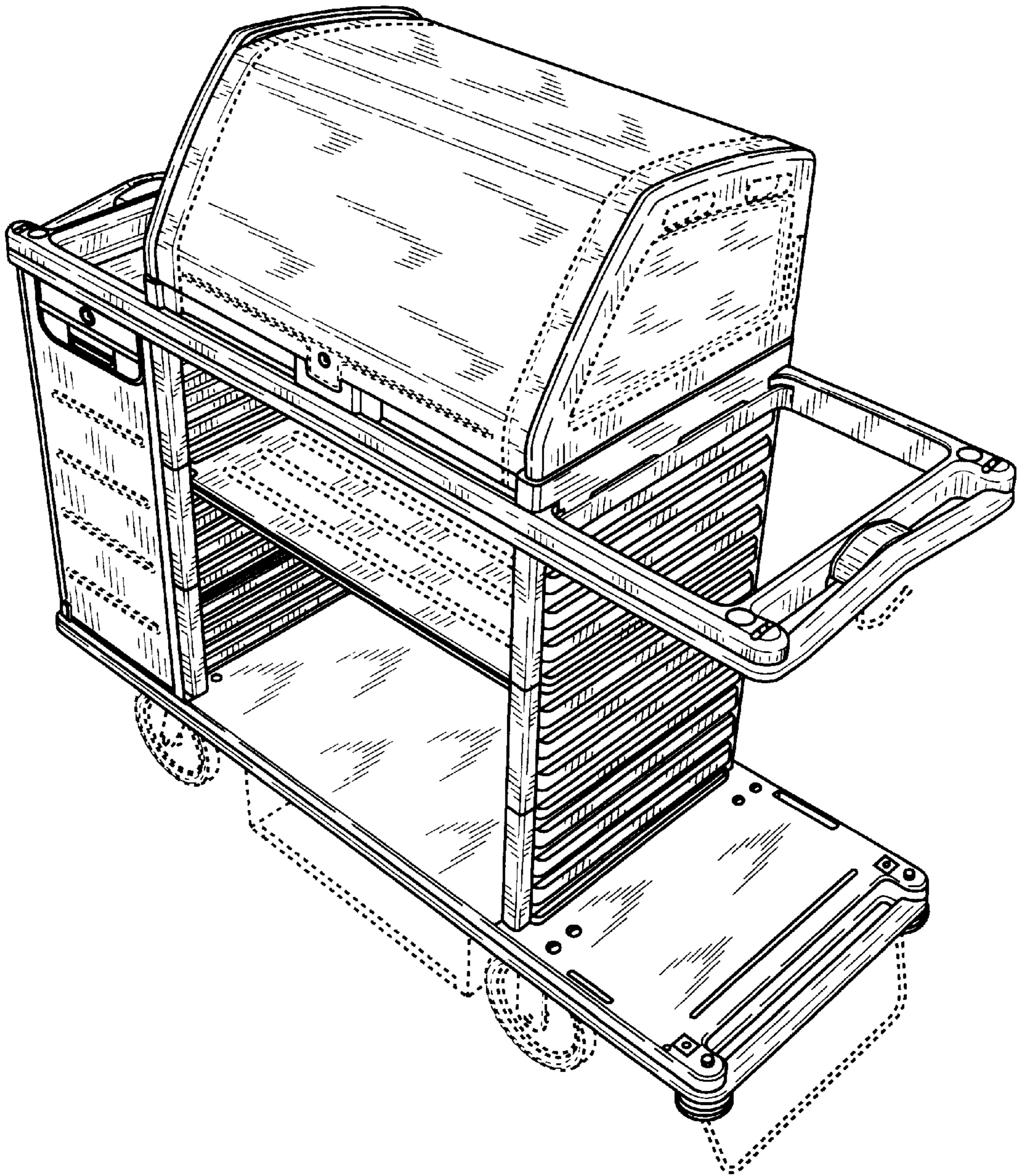

FIG. 1

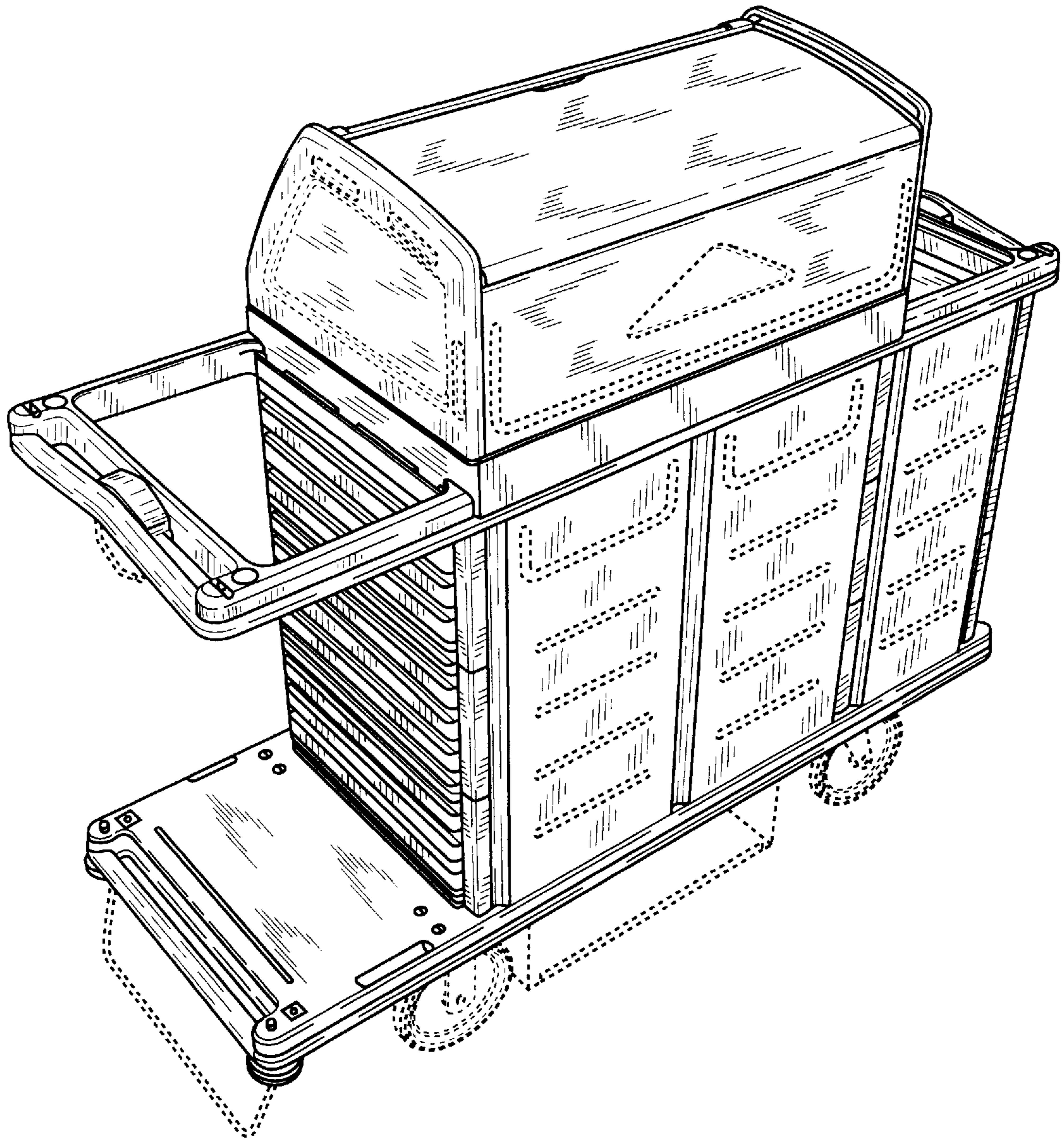

FIG. 2

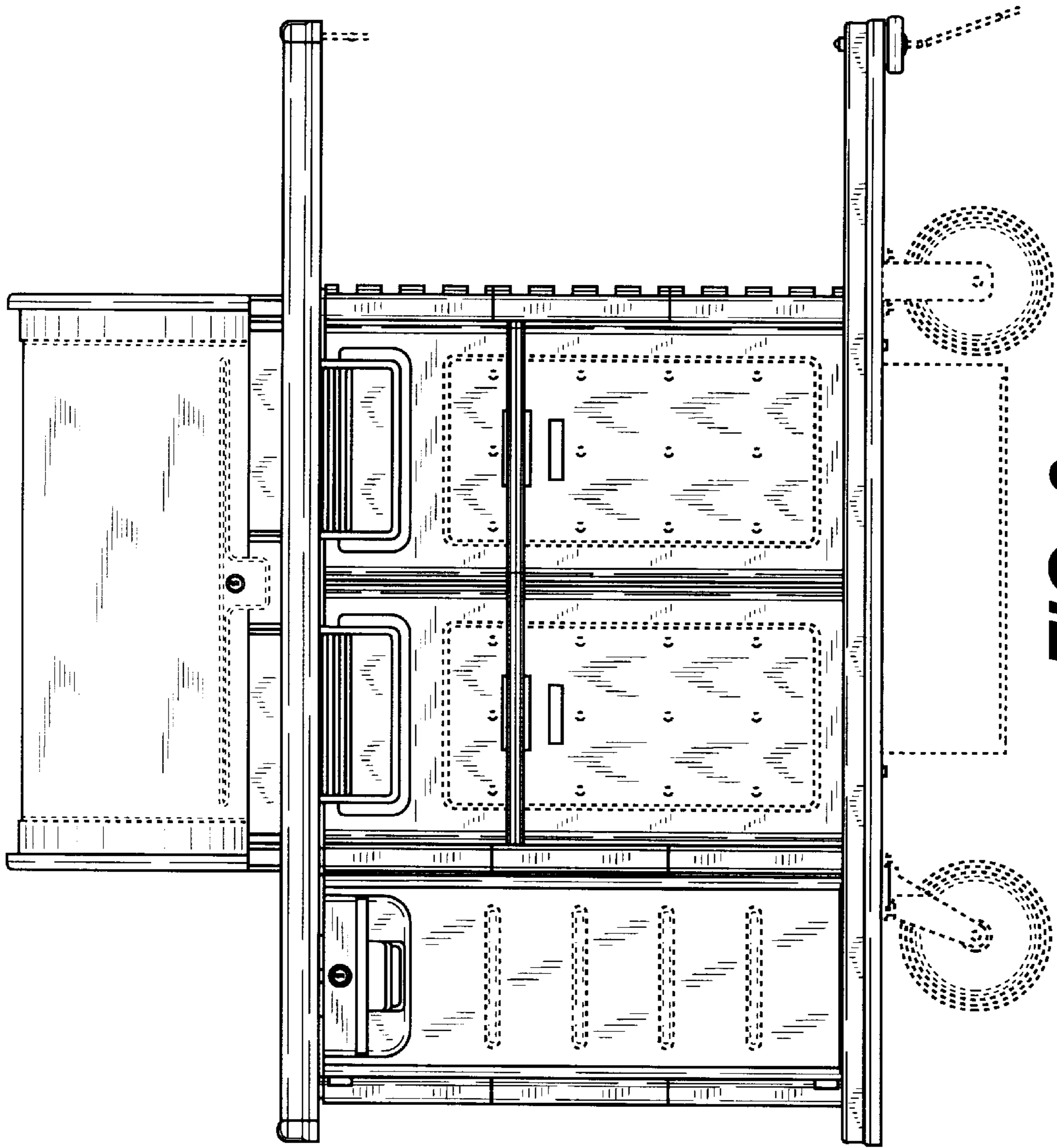

FIG. 3

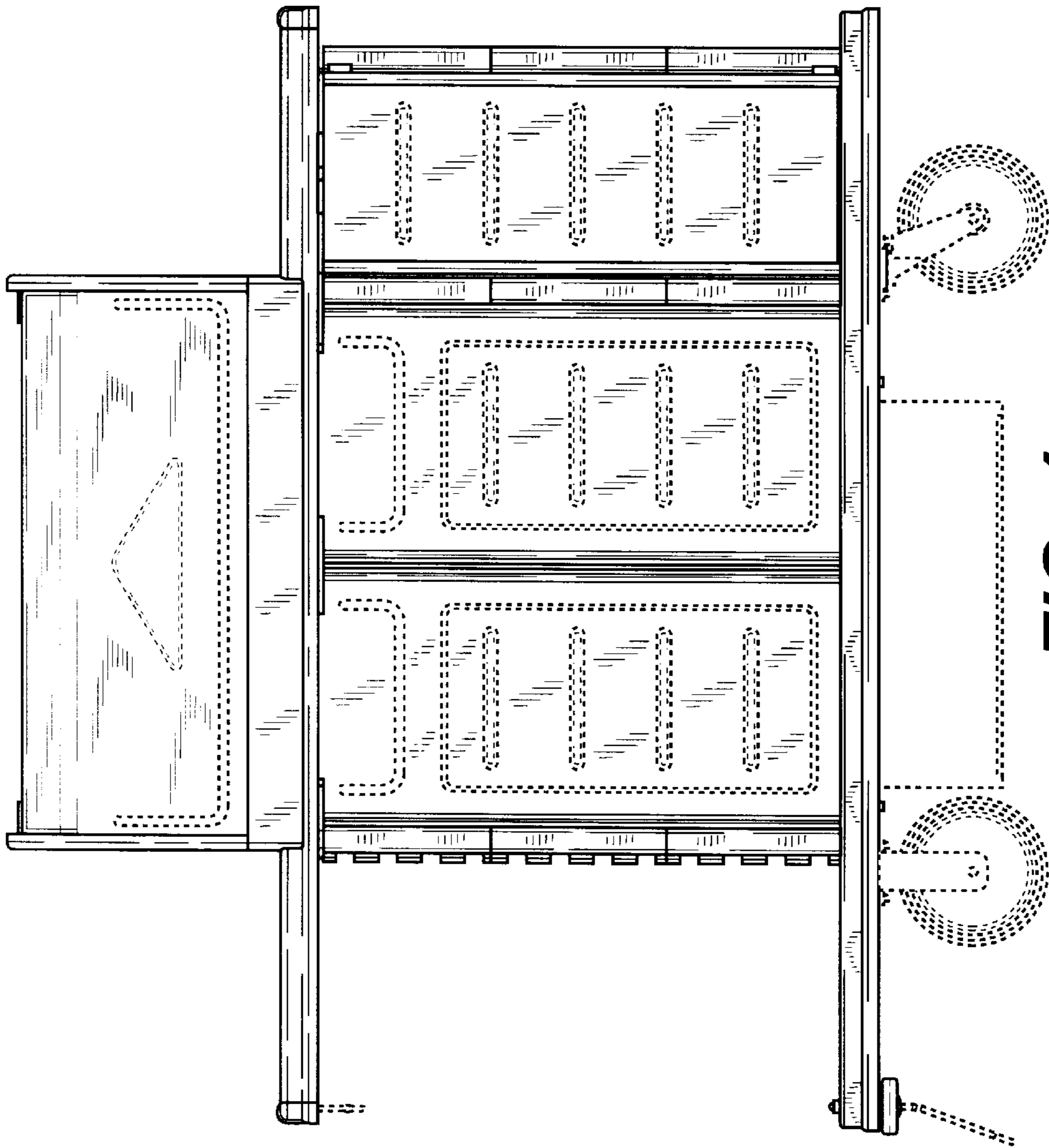

FIG. 4

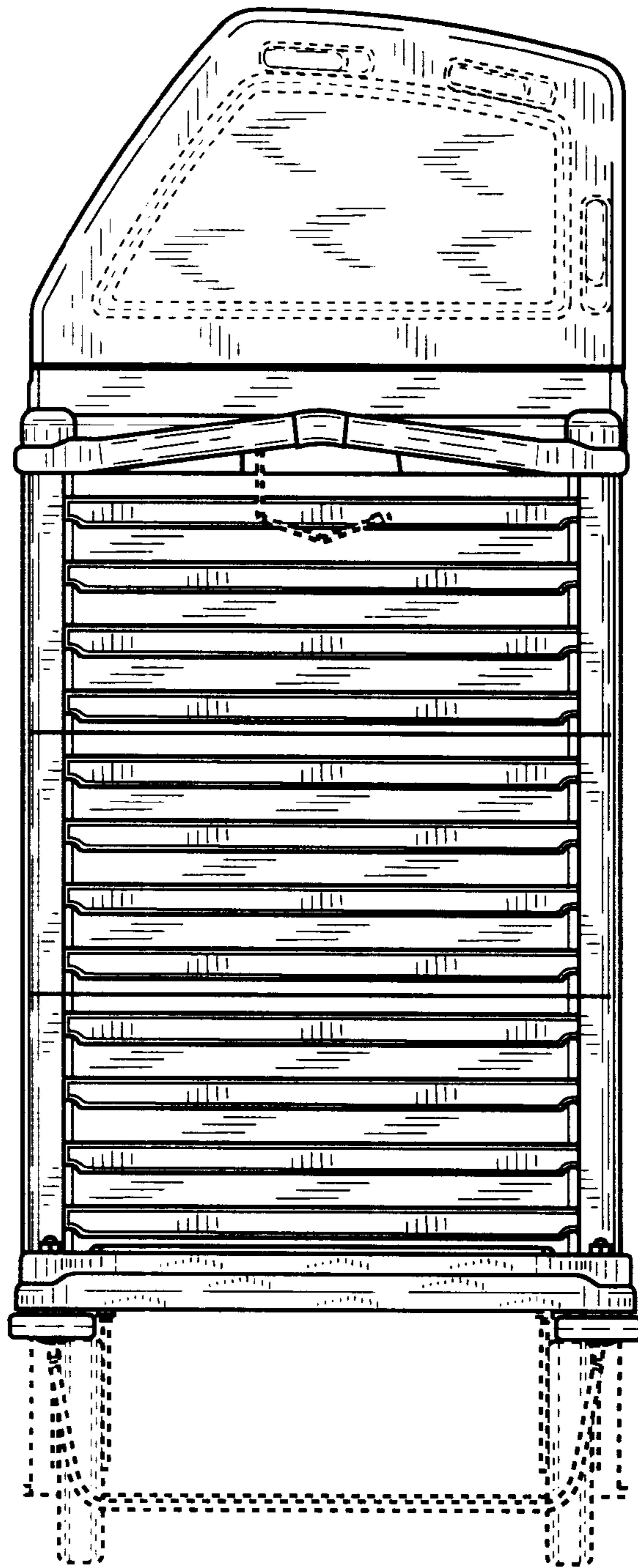

FIG. 5

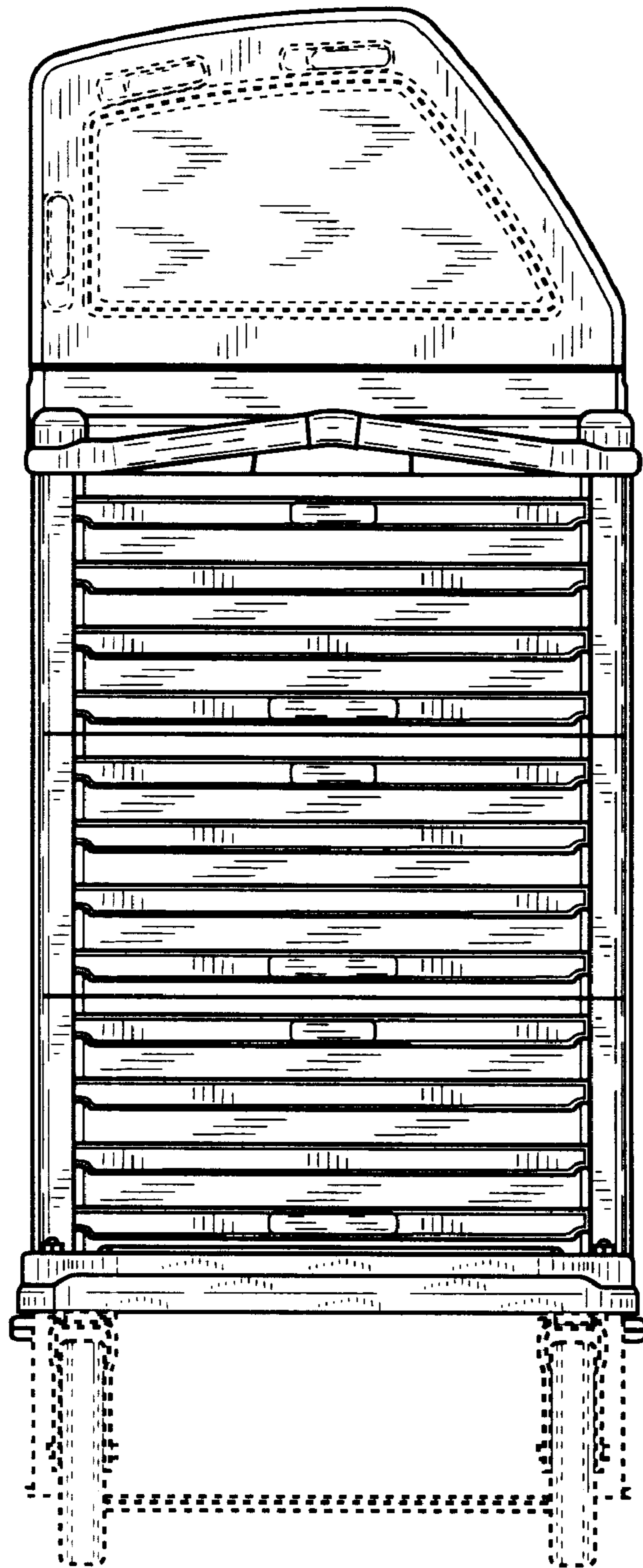

FIG. 6

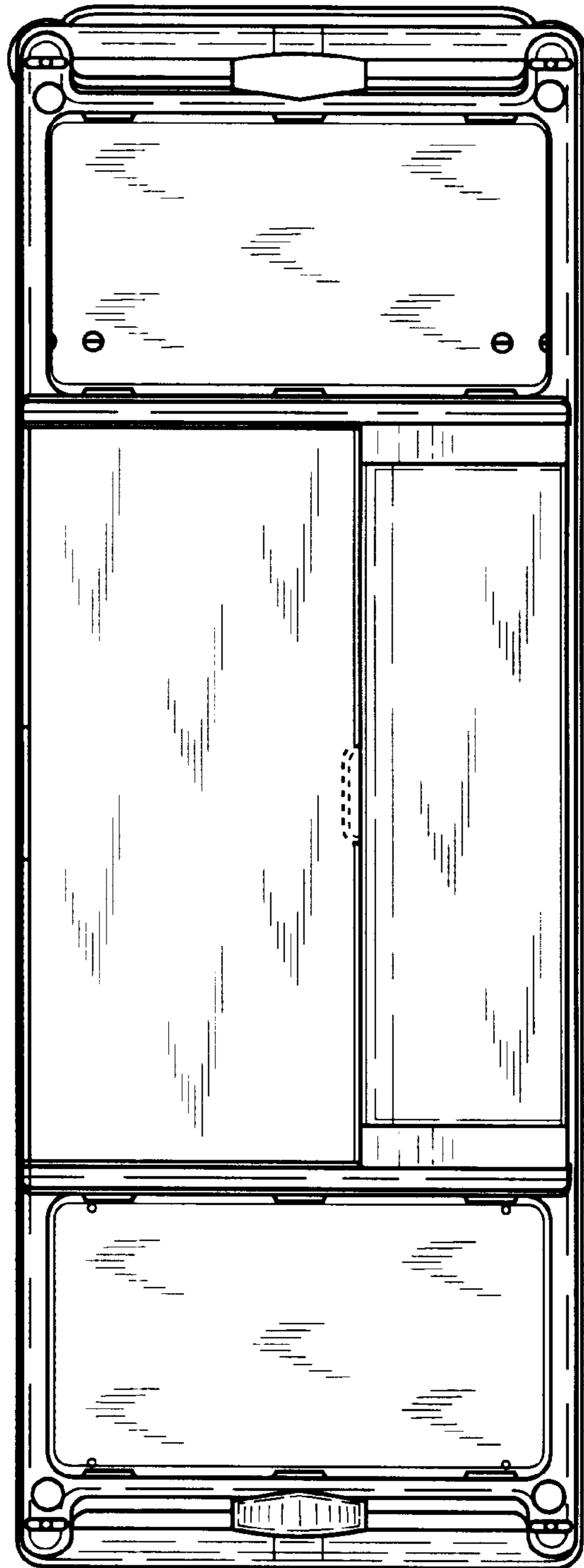

FIG. 7

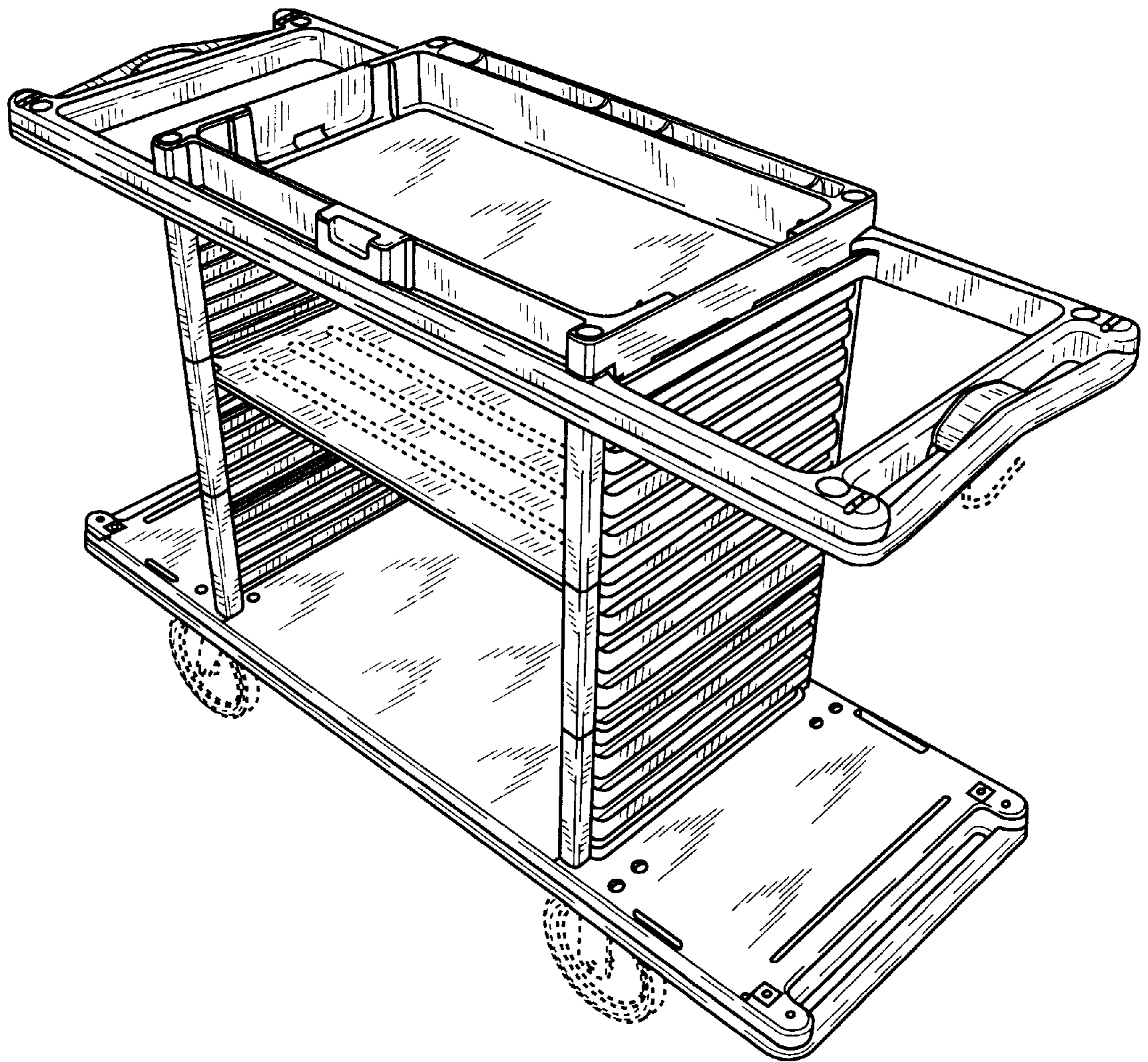

FIG. 8

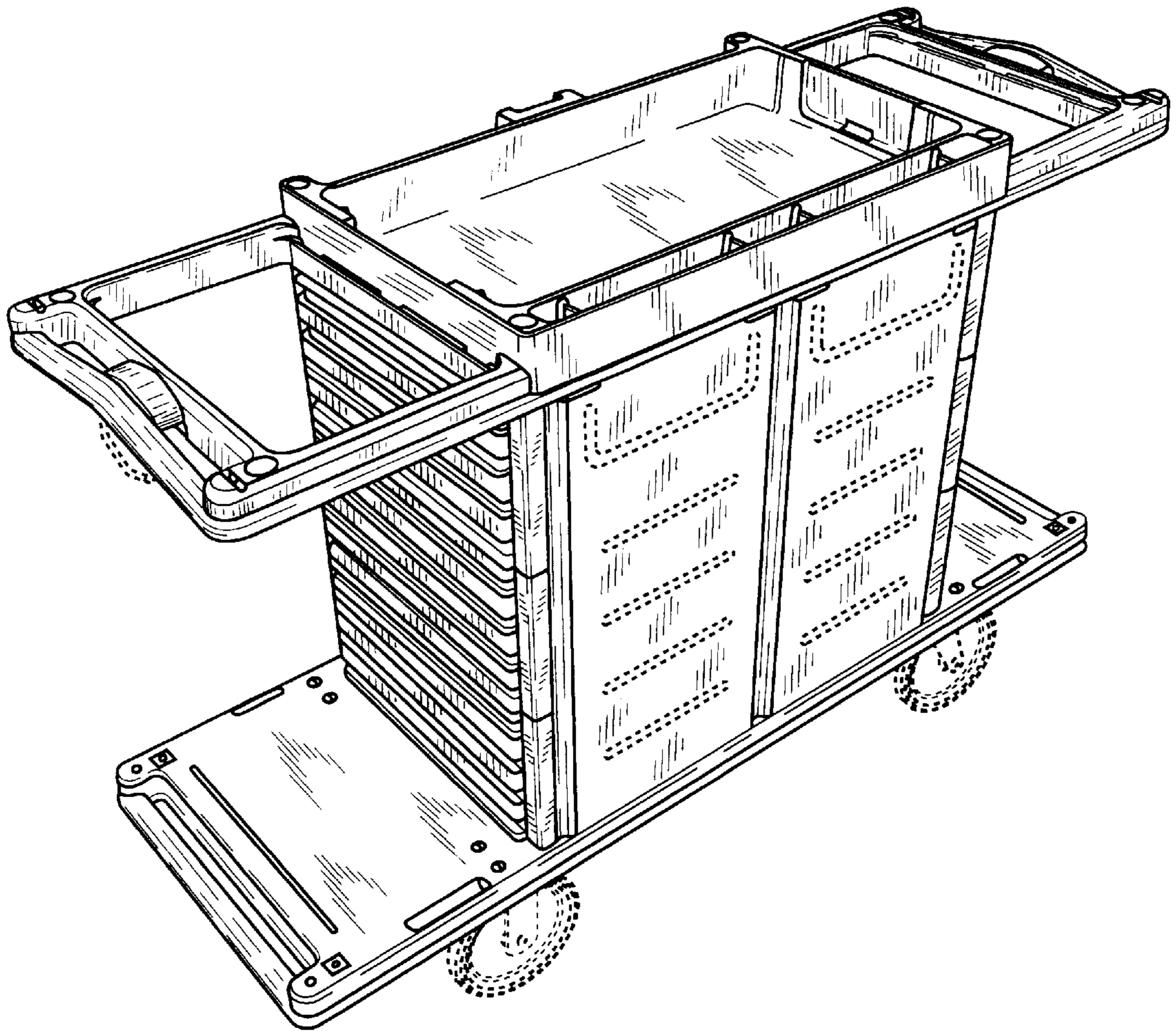

FIG. 9

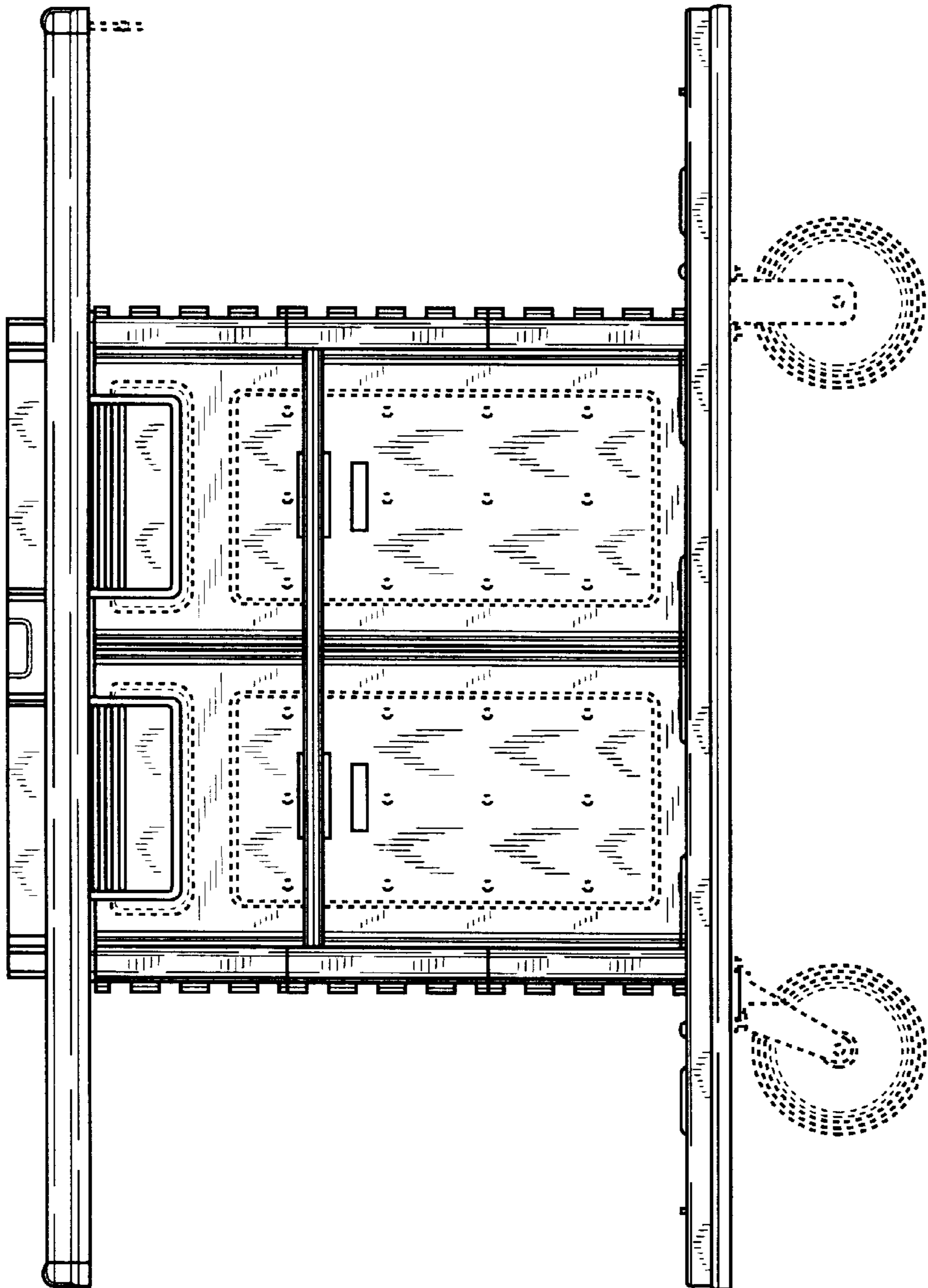

FIG. 10

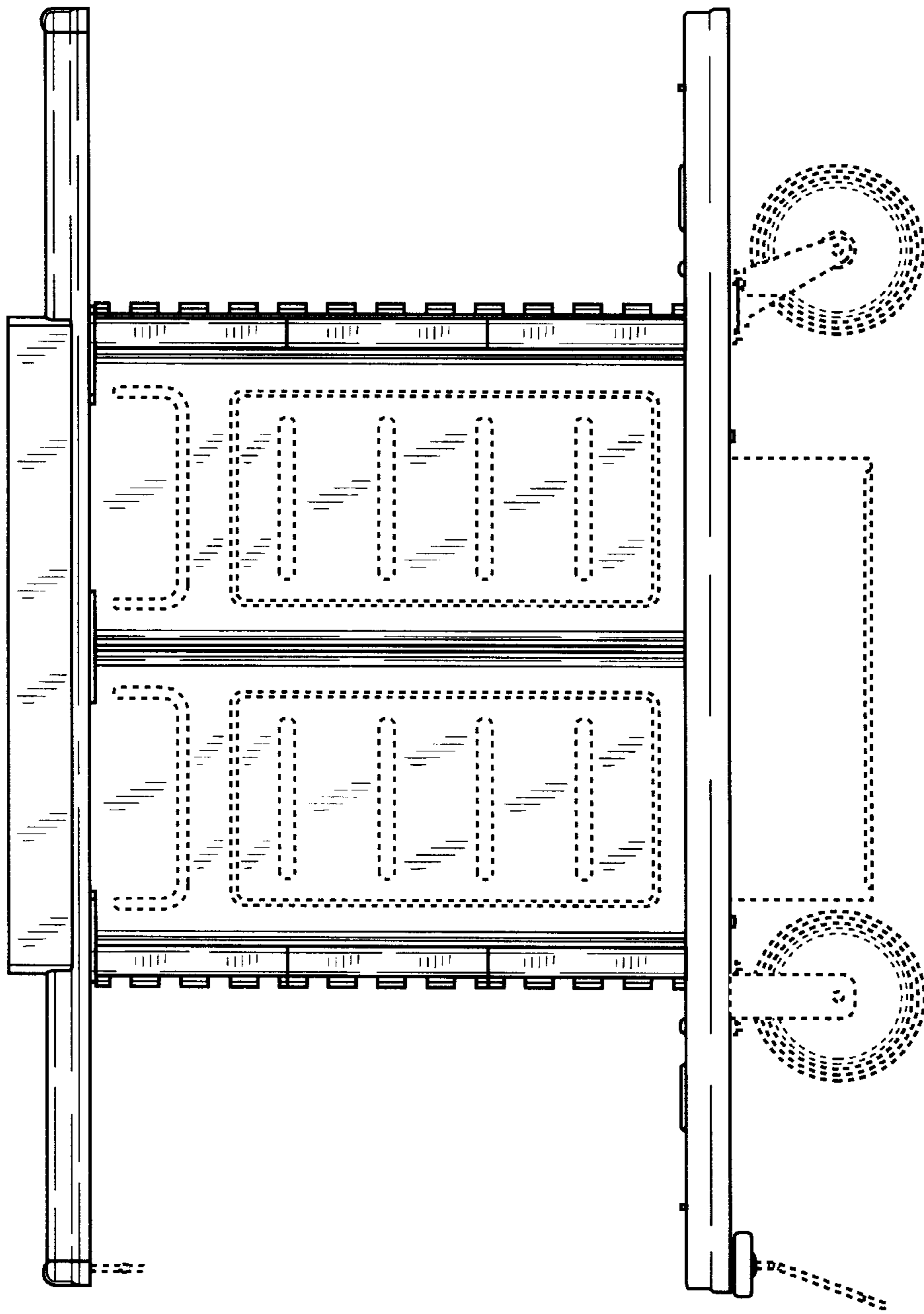

FIG. 11

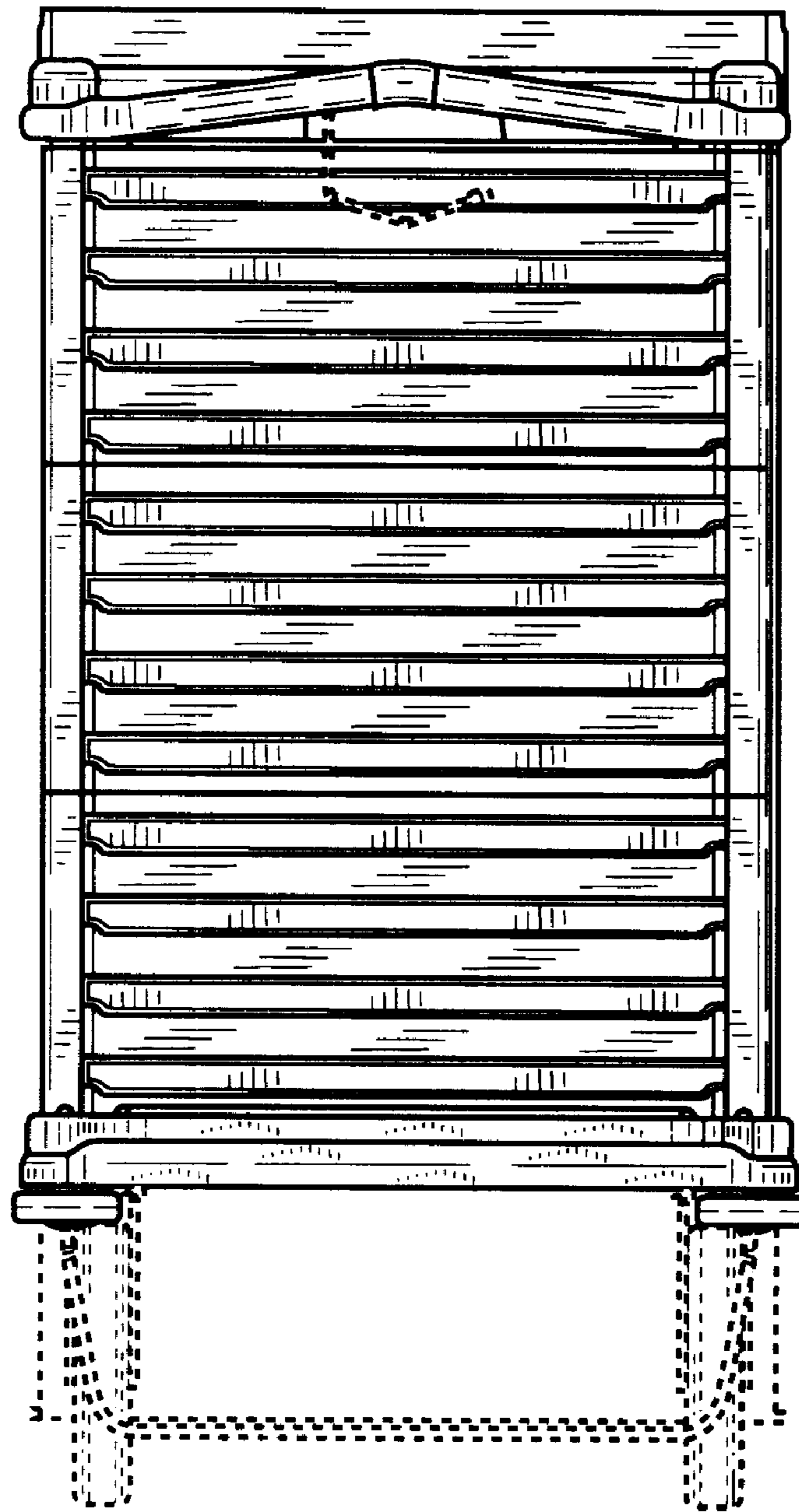

FIG. 12

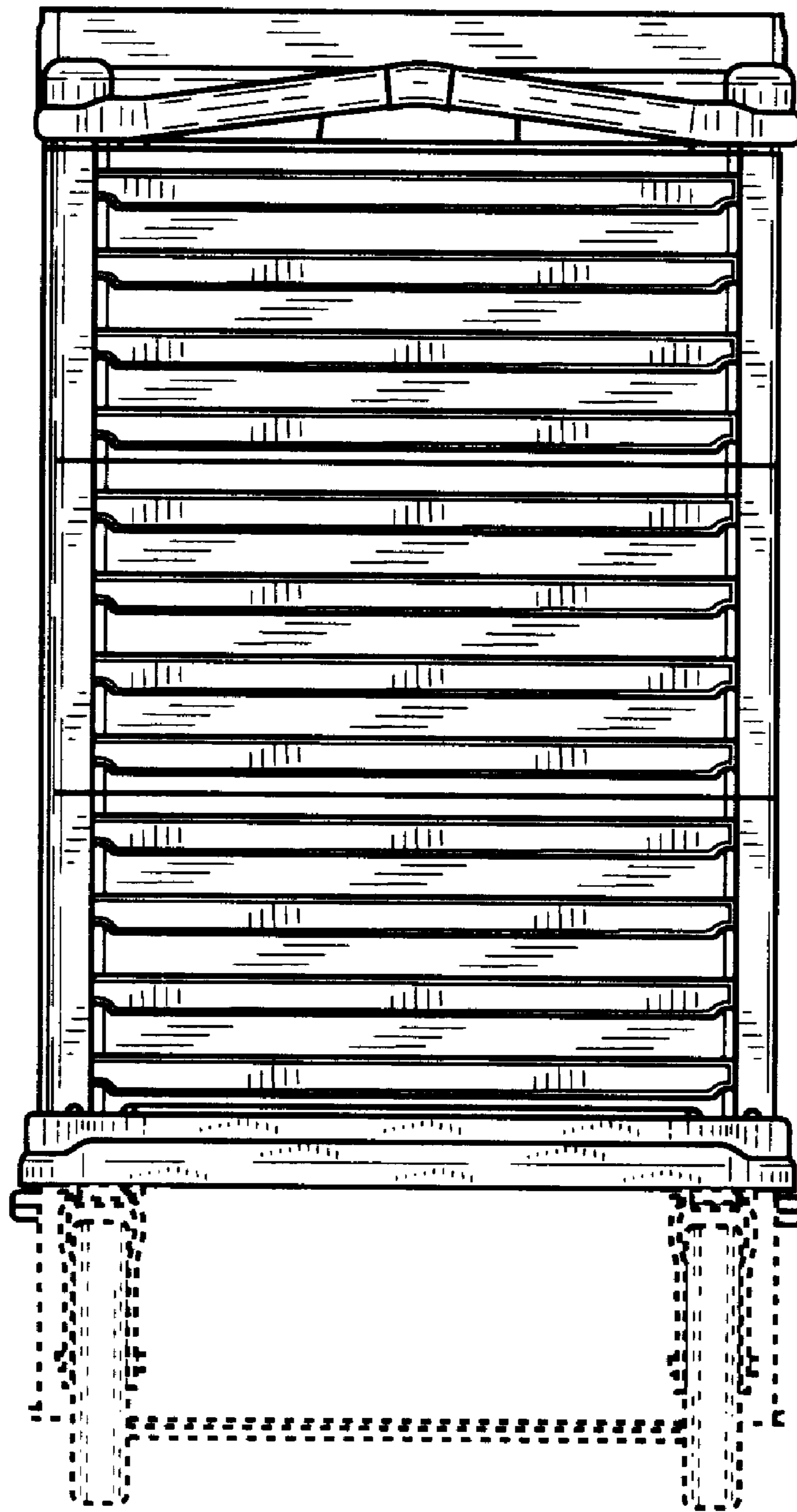

FIG. 13

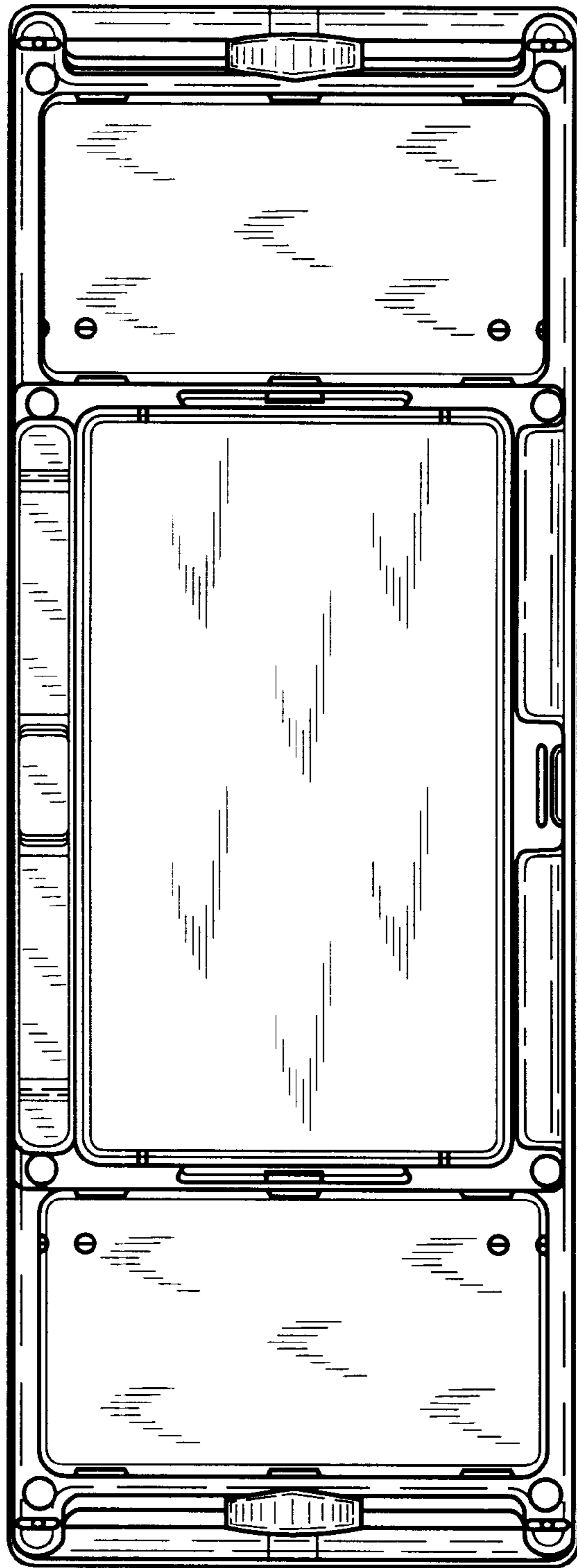

FIG. 14