



US00D464168S

(12) **United States Design Patent**  
**Reynolds et al.**

(10) **Patent No.: US D464,168 S**

(45) **Date of Patent: \*\* Oct. 8, 2002**

(54) **MULTI-FUNCTION CIGARETTE LIGHTER**

D452,037 S \* 12/2001 Smith ..... D27/143

(75) Inventors: **Michael P. Reynolds**, Warwick, RI  
(US); **Hwa Cheol Lim**, Seoul (KR)

\* cited by examiner

*Primary Examiner*—Jennifer Rivard

(73) Assignee: **Colibri Corporation**, Providence, RI  
(US)

(74) *Attorney, Agent, or Firm*—Salter & Michaelson

(\*\*) Term: **14 Years**

(57) **CLAIM**

The ornamental design for a multi-function cigarette lighter,  
as shown and described.

(21) Appl. No.: **29/156,248**

**DESCRIPTION**

(22) Filed: **Feb. 26, 2002**

(51) **LOC (7) Cl.** ..... **27-05**

(52) **U.S. Cl.** ..... **D27/142; D8/34; D8/105**

(58) **Field of Search** ..... D27/141-143,  
D27/154, 155, 157, 159; D8/34, 105; 431/253

FIG. 1 is a perspective view of a multi-function cigarette  
lighter showing our new design;

FIG. 2 is a rear elevational view thereof;

FIG. 3 is a front elevational view thereof;

FIG. 4 is a left side view thereof;

FIG. 5 is a right side view thereof;

FIG. 6 is a top plan view thereof;

FIG. 7 is a bottom plan view thereof; and,

FIG. 8 is a perspective view thereof showing the knife blade  
and bottle opener in partially open position and the cigarette  
lighter cap in open position.

(56) **References Cited**

**U.S. PATENT DOCUMENTS**

5,169,305	A	*	12/1992	Kee	.....	431/253
5,653,525	A	*	8/1997	Park	.....	431/253
5,829,965	A	*	11/1998	Rubalcava	.....	431/253
D435,141	S		12/2000	Reynolds		

**1 Claim, 5 Drawing Sheets**

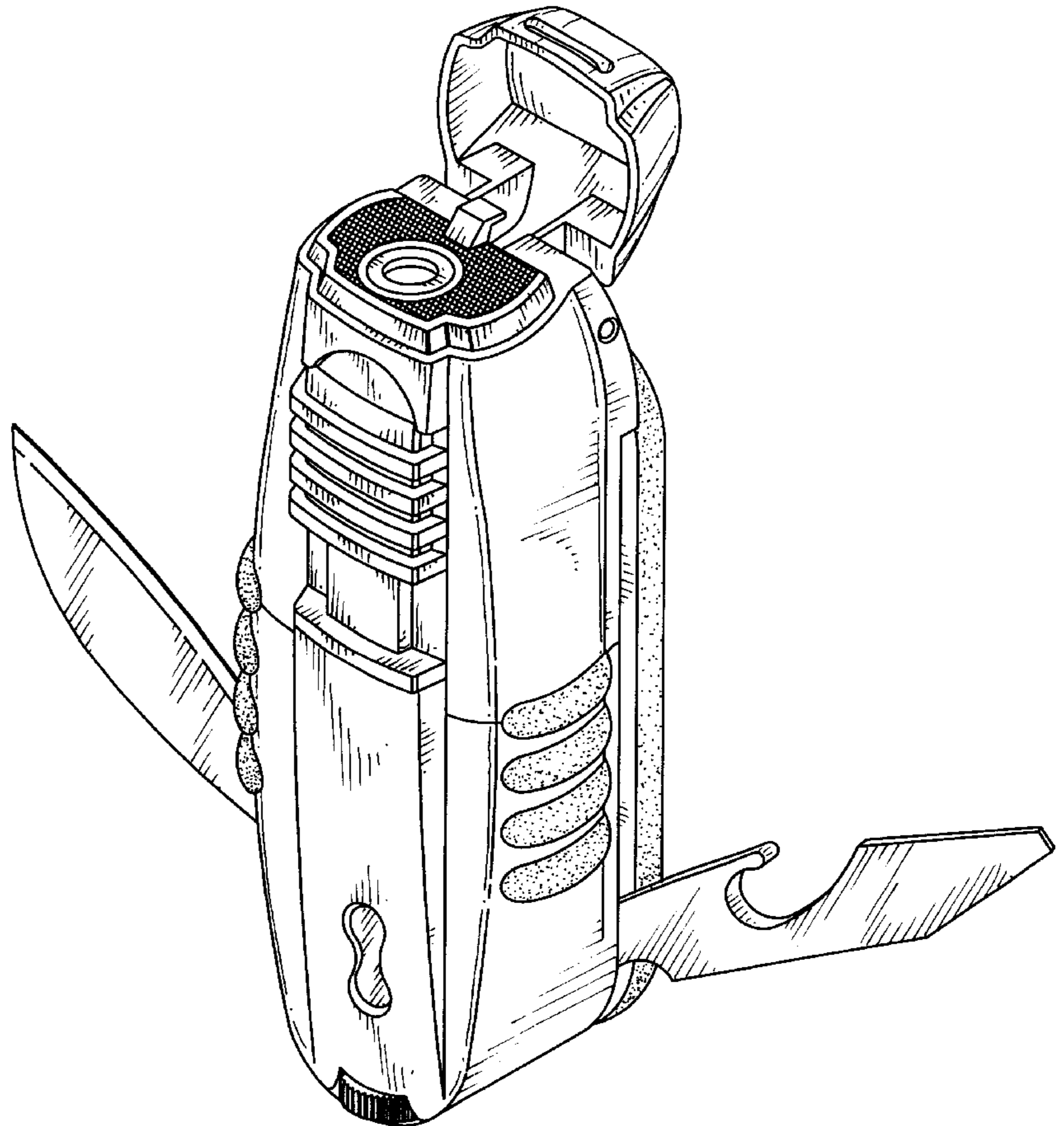
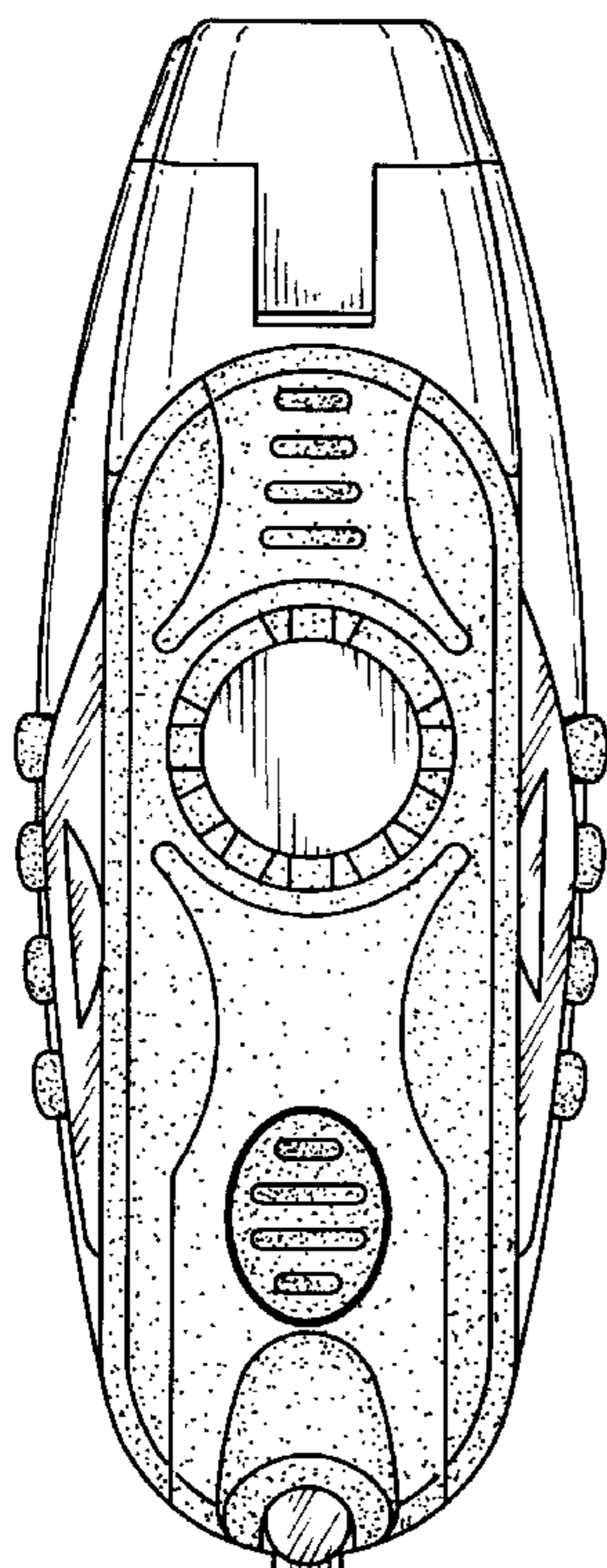

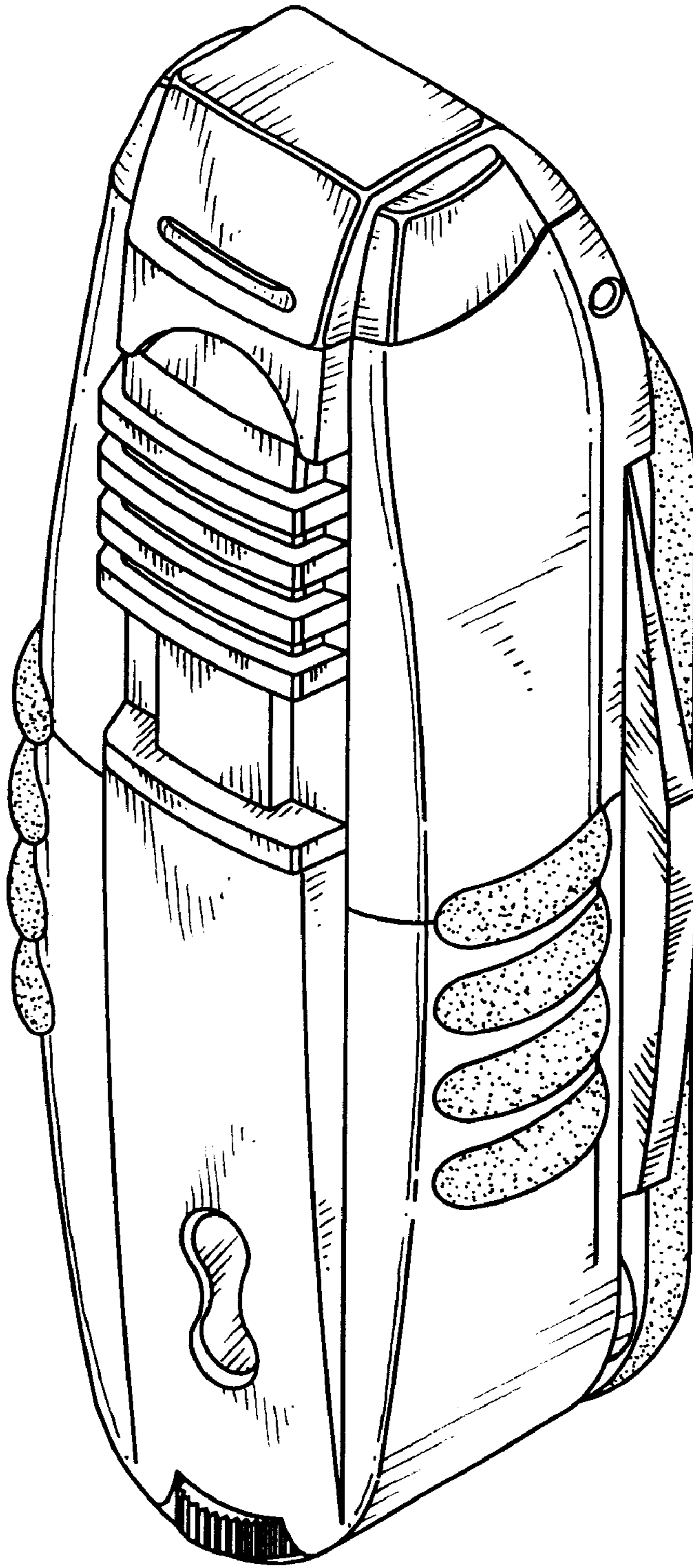

FIG. 1

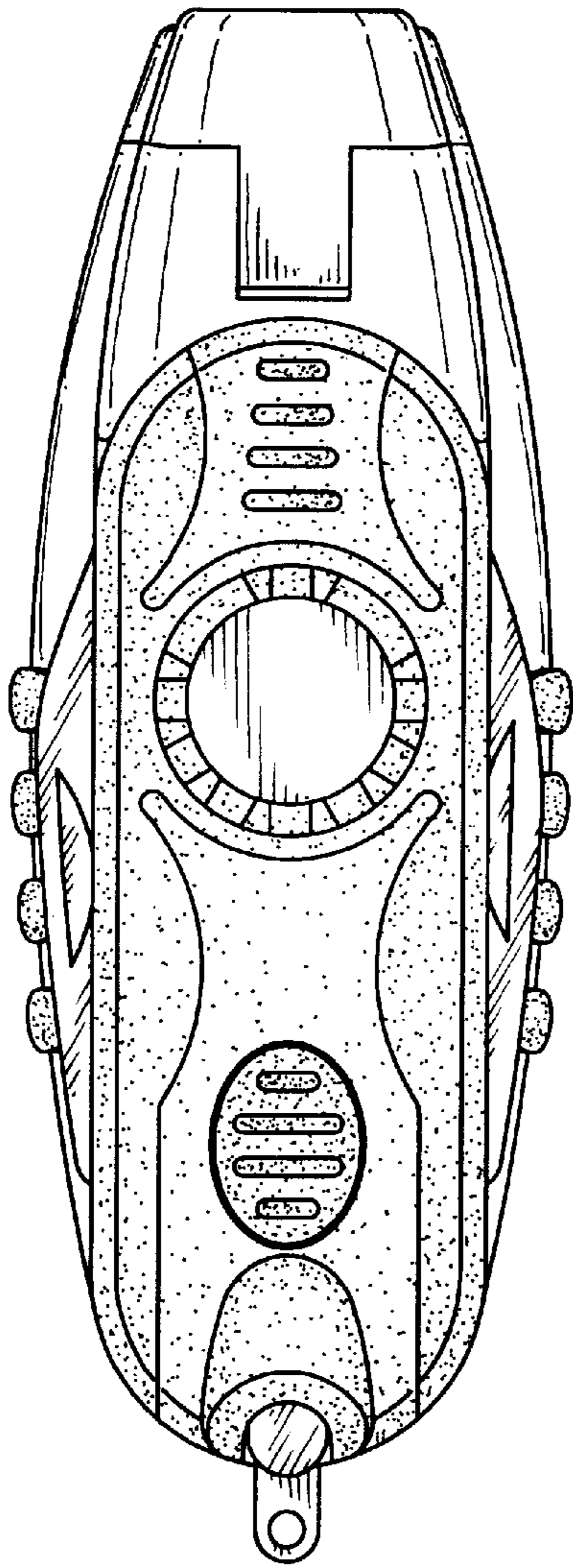
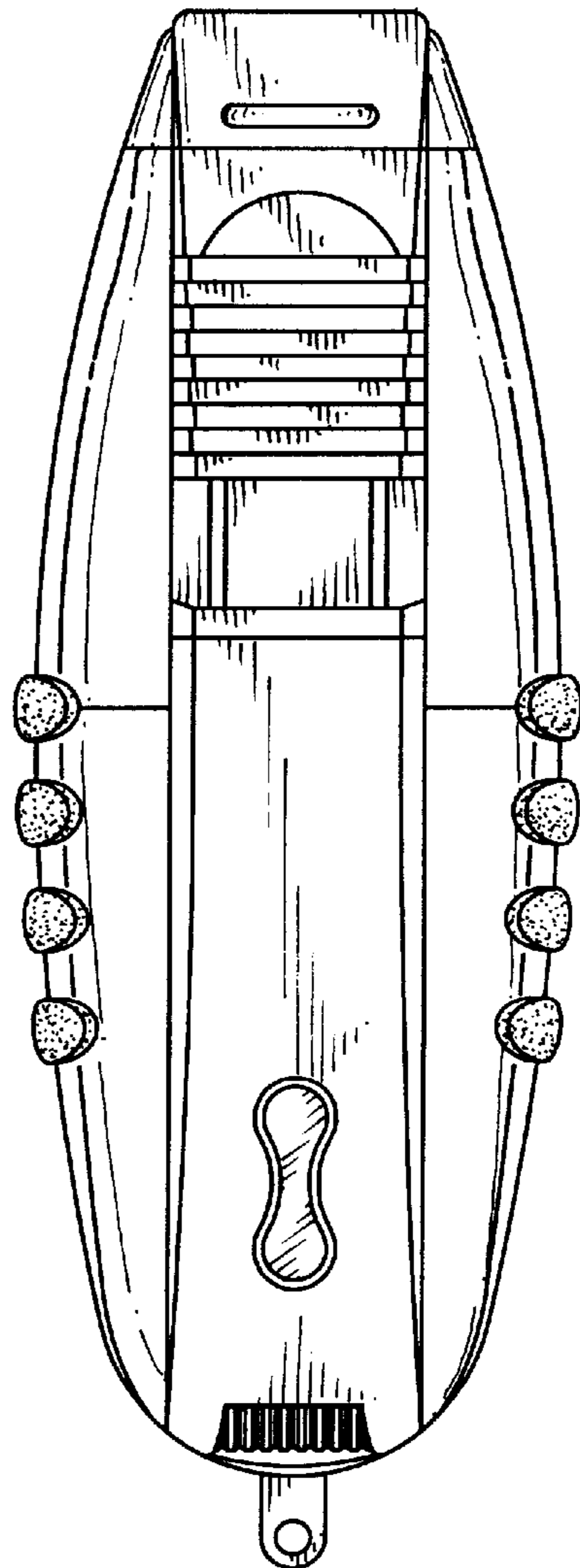

FIG. 2

FIG. 3



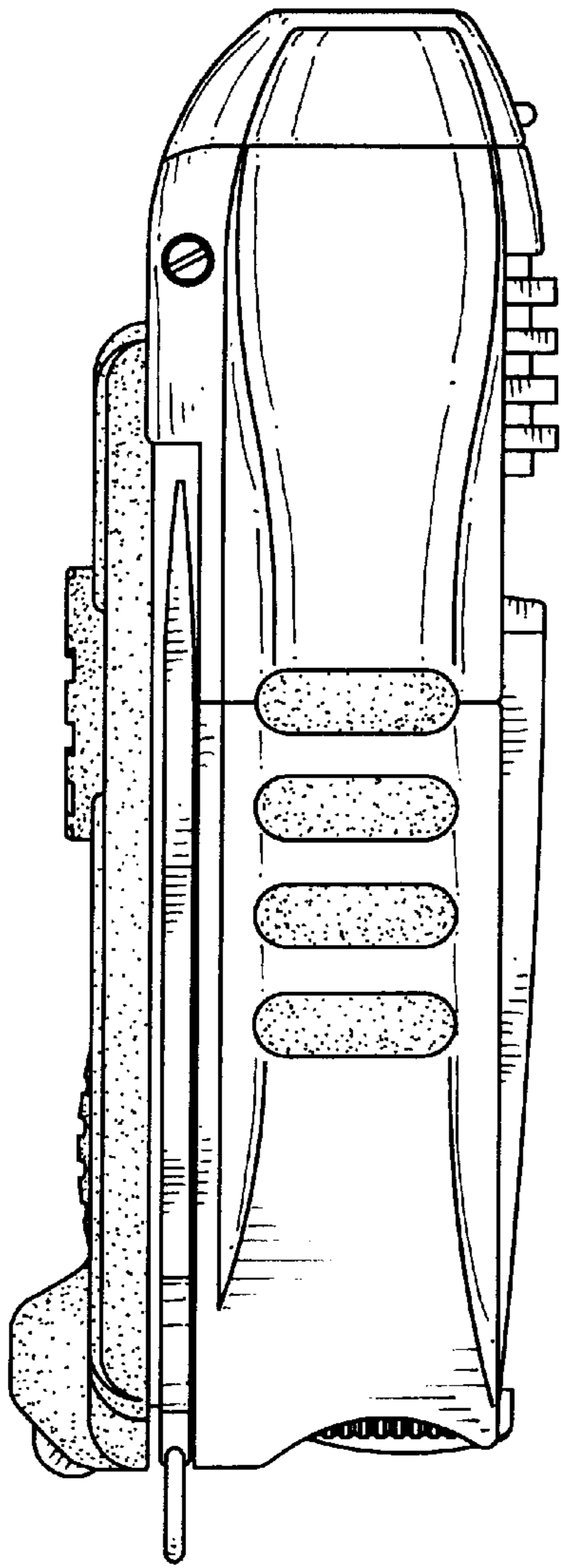

FIG. 4

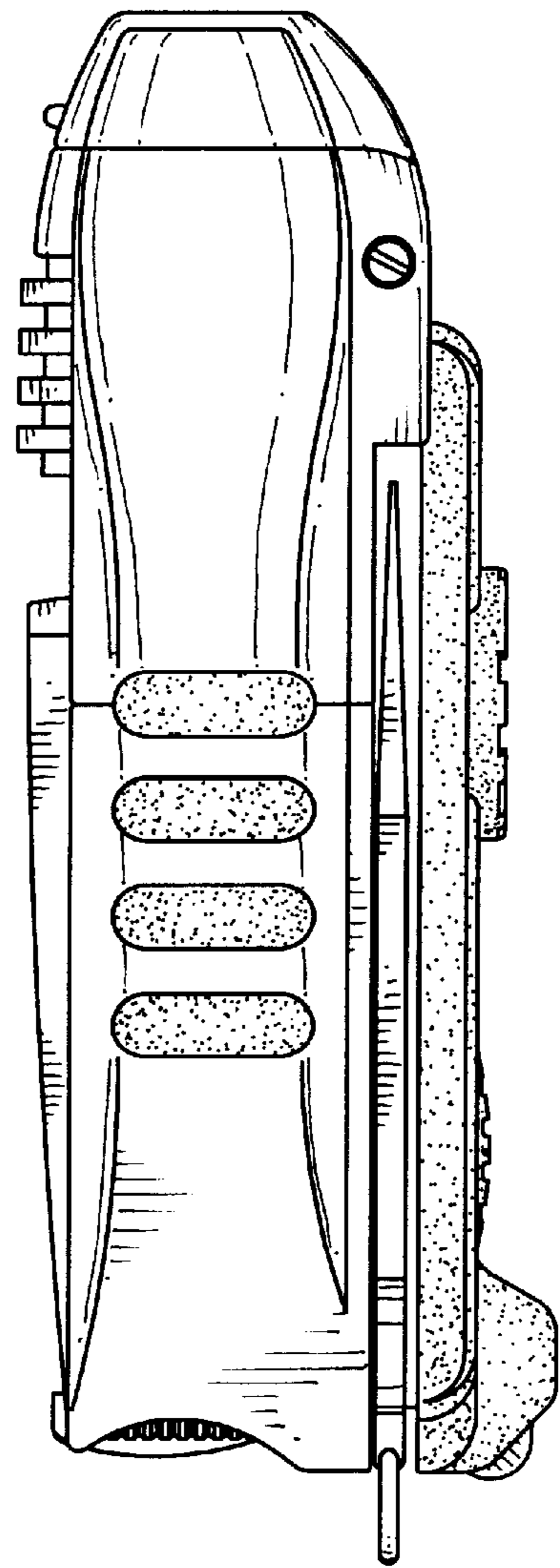

FIG. 5

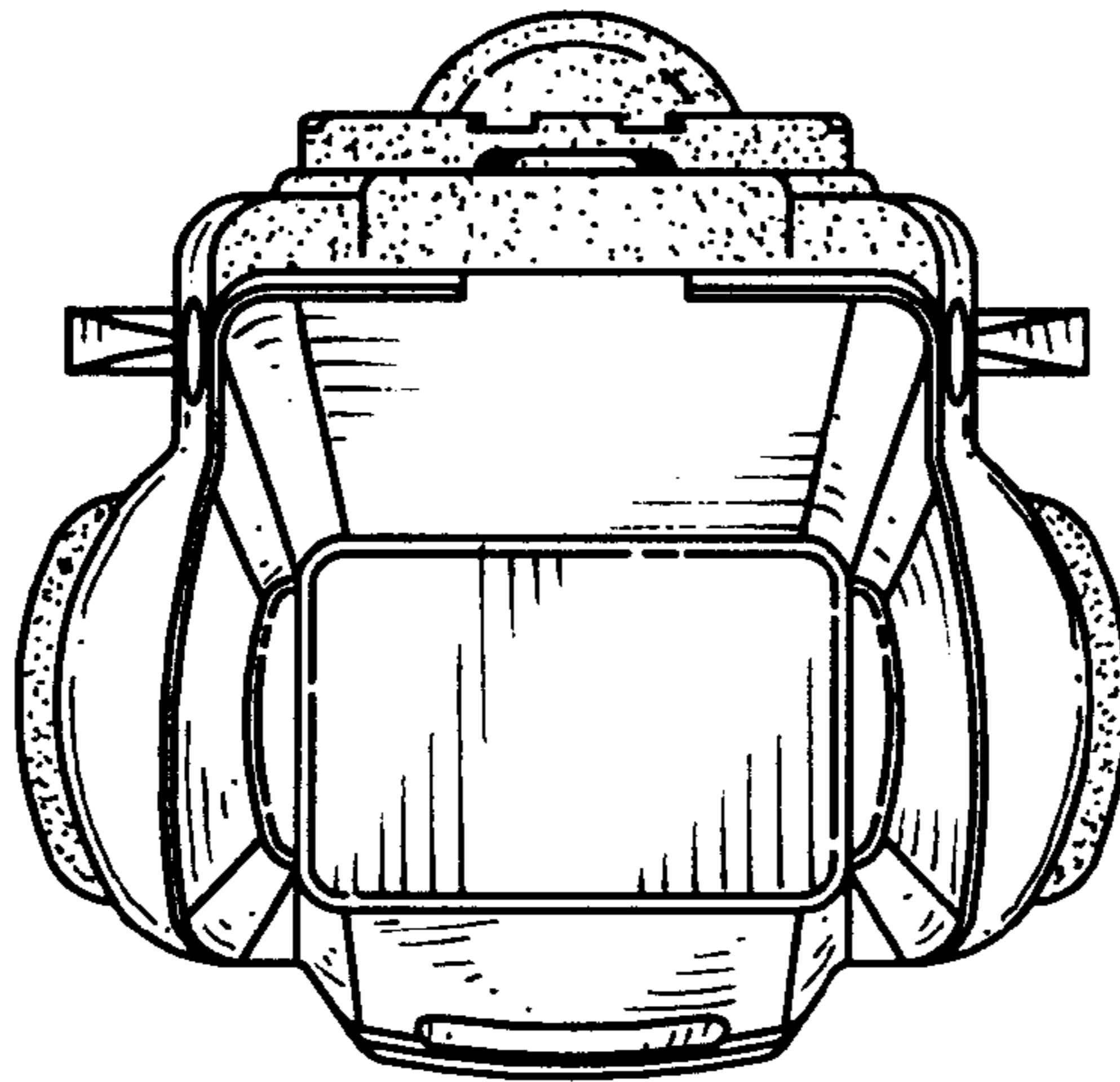

FIG. 6

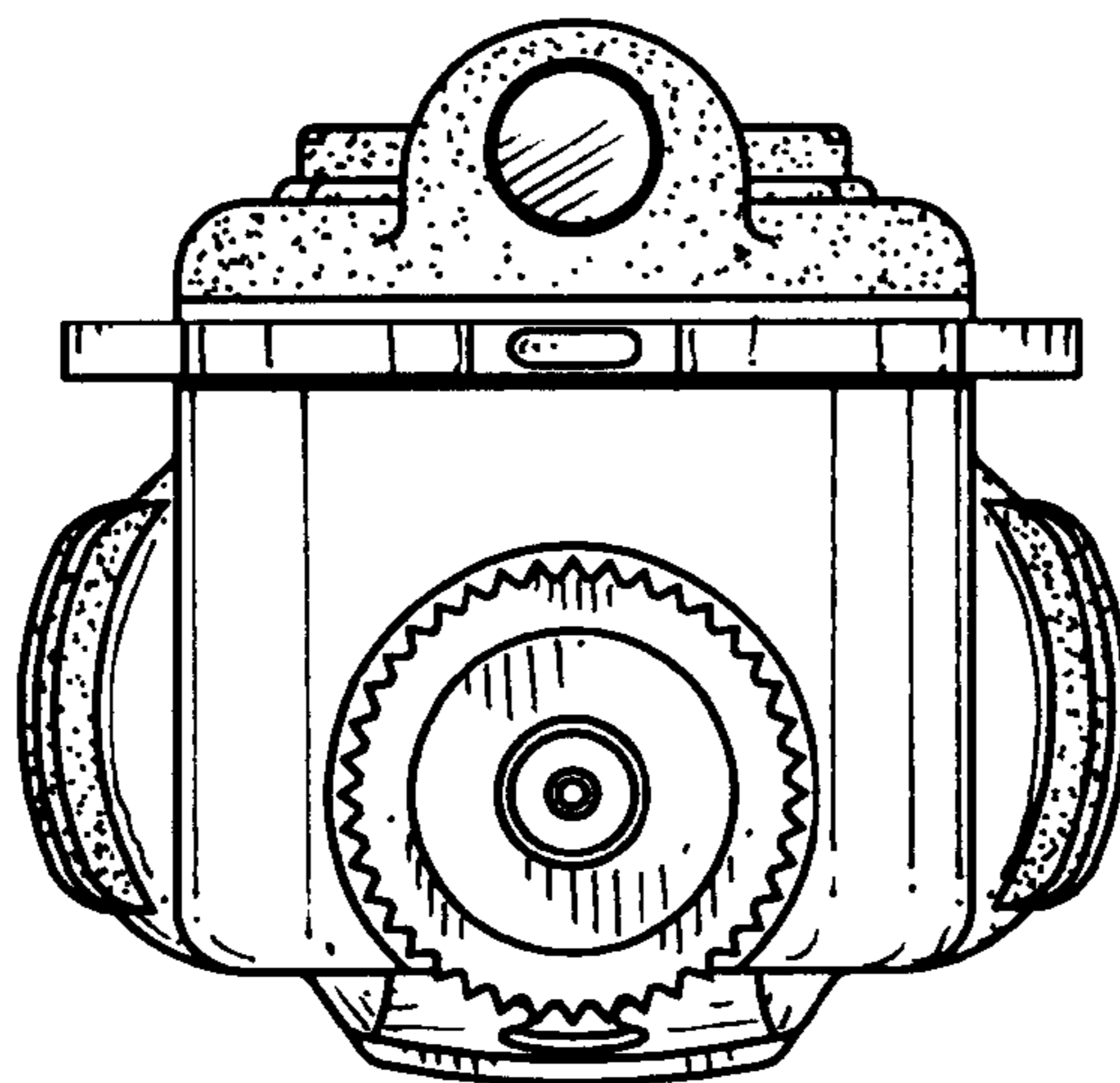

FIG. 7

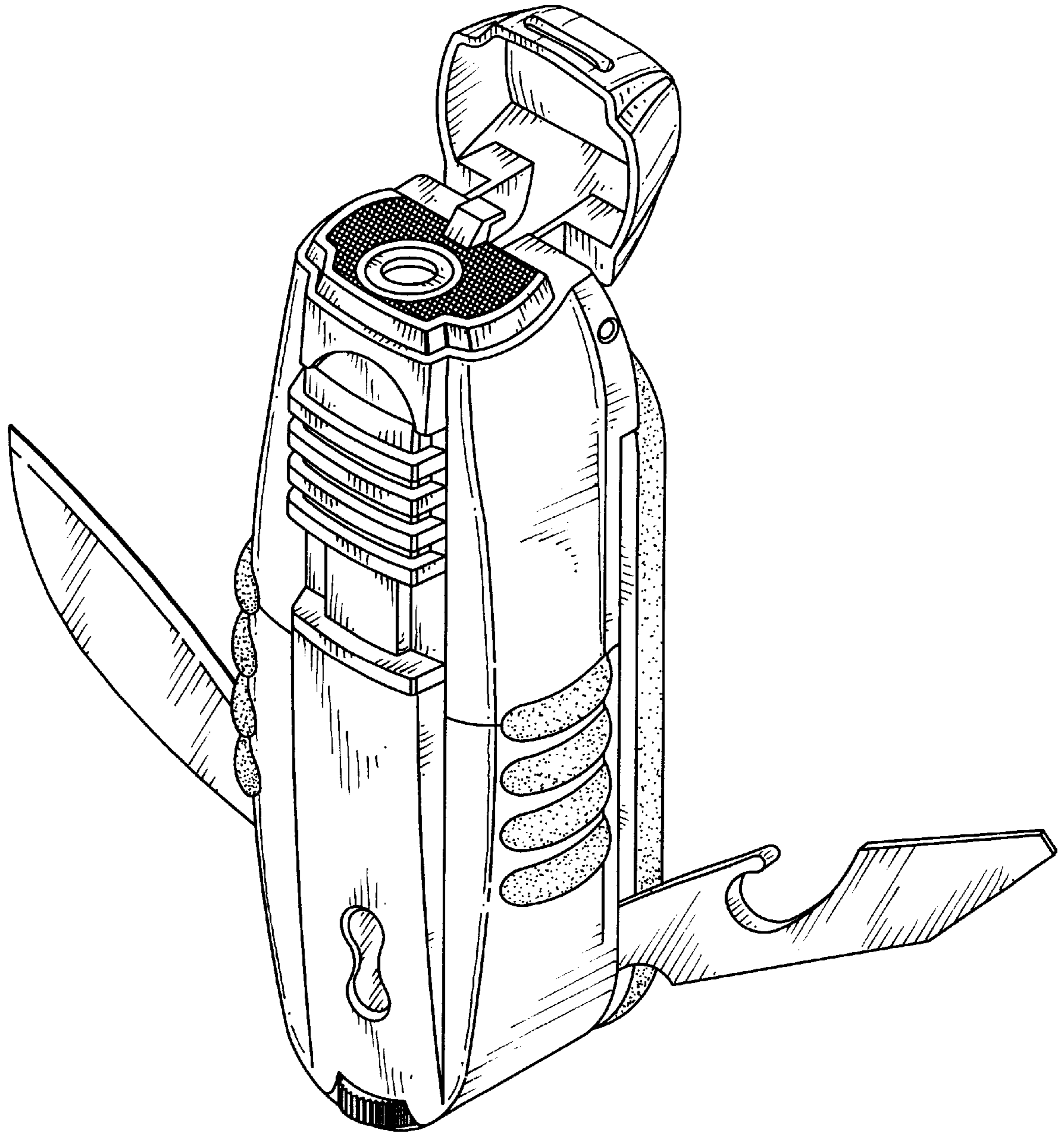

FIG. 8