



US00D464152S

(12) **United States Design Patent**
Nelson et al.

(10) **Patent No.:** **US D464,152 S**

(45) **Date of Patent:** **** Oct. 8, 2002**

(54) **THRESHOLD MOLDING**

(76) Inventors: **Richard C. Nelson**, 312 Preakness La., Sneads Ferry, NC (US) 28460; **Roger C. Jones**, 151 Grace La., Richlands, NC (US) 28574

(**) Term: **14 Years**

(21) Appl. No.: **29/137,176**

(22) Filed: **Feb. 14, 2001**

(51) **LOC (7) Cl.** **25-01**

(52) **U.S. Cl.** **D25/136**

(58) **Field of Search** 52/287.1, 312, 52/717.01, 717.03; D25/136; 49/467-471

(56) **References Cited**

U.S. PATENT DOCUMENTS

3,077,012 A	*	2/1963	Speraw	52/287.1
D327,747 S	*	7/1992	Wildening	D25/136
D330,434 S	*	10/1992	Watters	D25/136
D373,203 S	*	8/1996	Kornfalt et al.	D25/136

* cited by examiner

Primary Examiner—Doris Clark

(74) *Attorney, Agent, or Firm*—MacCord Mason PLLC

(57) **CLAIM**

We claim the ornamental design for a threshold molding, as shown and described.

DESCRIPTION

FIG. 1 is a perspective view of a first embodiment.
 FIG. 2 is a top view of the embodiment shown in FIG. 1.
 FIG. 3 is a front view of the embodiment shown in FIG. 1.
 FIG. 4 is a rear view of the embodiment shown in FIG. 1.
 FIG. 5 is a bottom view of the embodiment shown in FIG. 1.
 FIG. 6 is a left end view of the embodiment shown in FIG. 1.
 FIG. 7 is a right end view of the embodiment shown in FIG. 1.
 FIG. 8 is a perspective view of a second embodiment.
 FIG. 9 is a top view of the embodiment shown in FIG. 8.
 FIG. 10 is a front view of the embodiment shown in FIG. 8.
 FIG. 11 is a rear view of the embodiment shown in FIG. 8.
 FIG. 12 is a bottom view of the embodiment shown in FIG. 8.
 FIG. 13 is a left end view of the embodiment shown in FIG. 8; and,
 FIG. 14 is a right end view of the embodiment shown in FIG. 8.

1 Claim, 2 Drawing Sheets

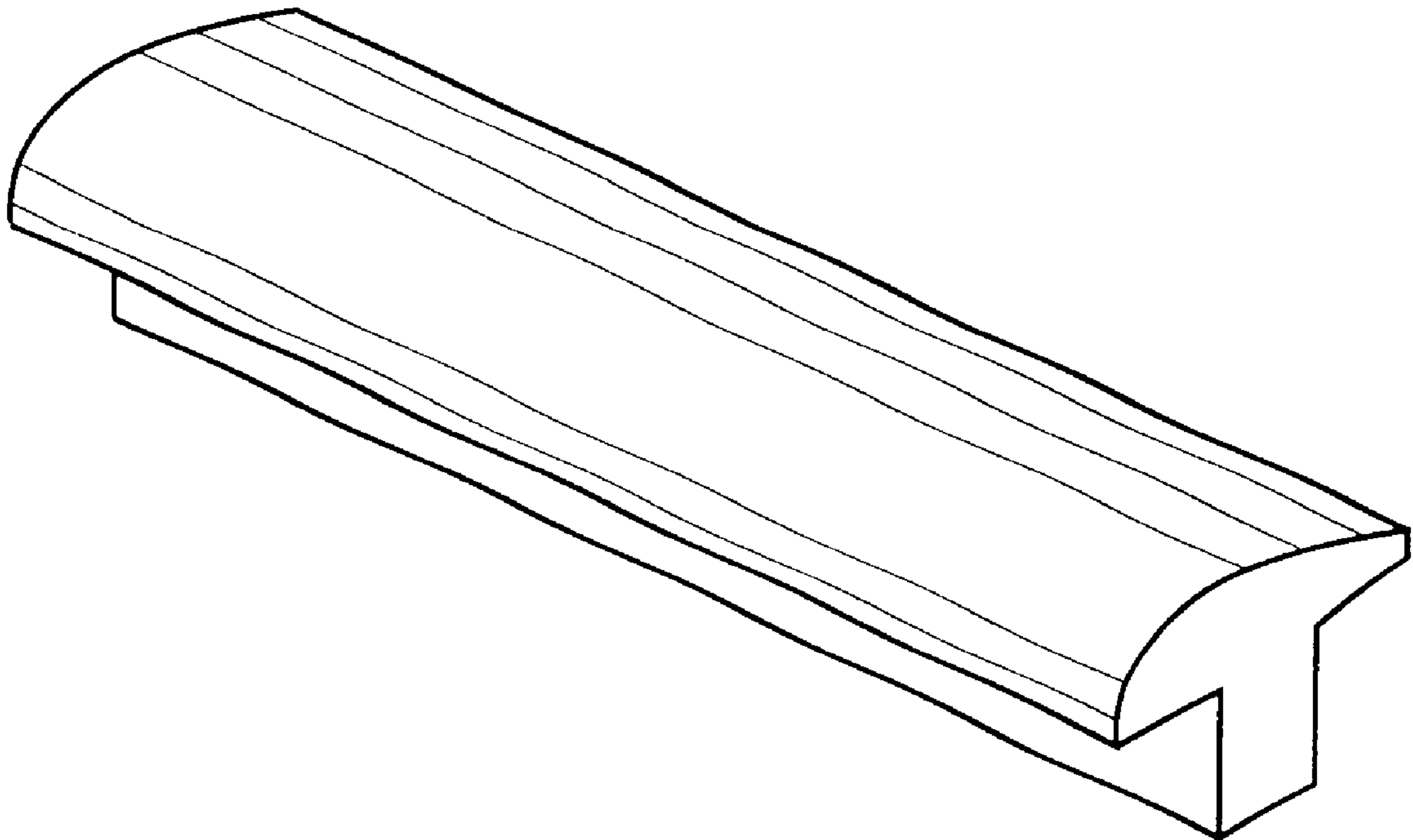

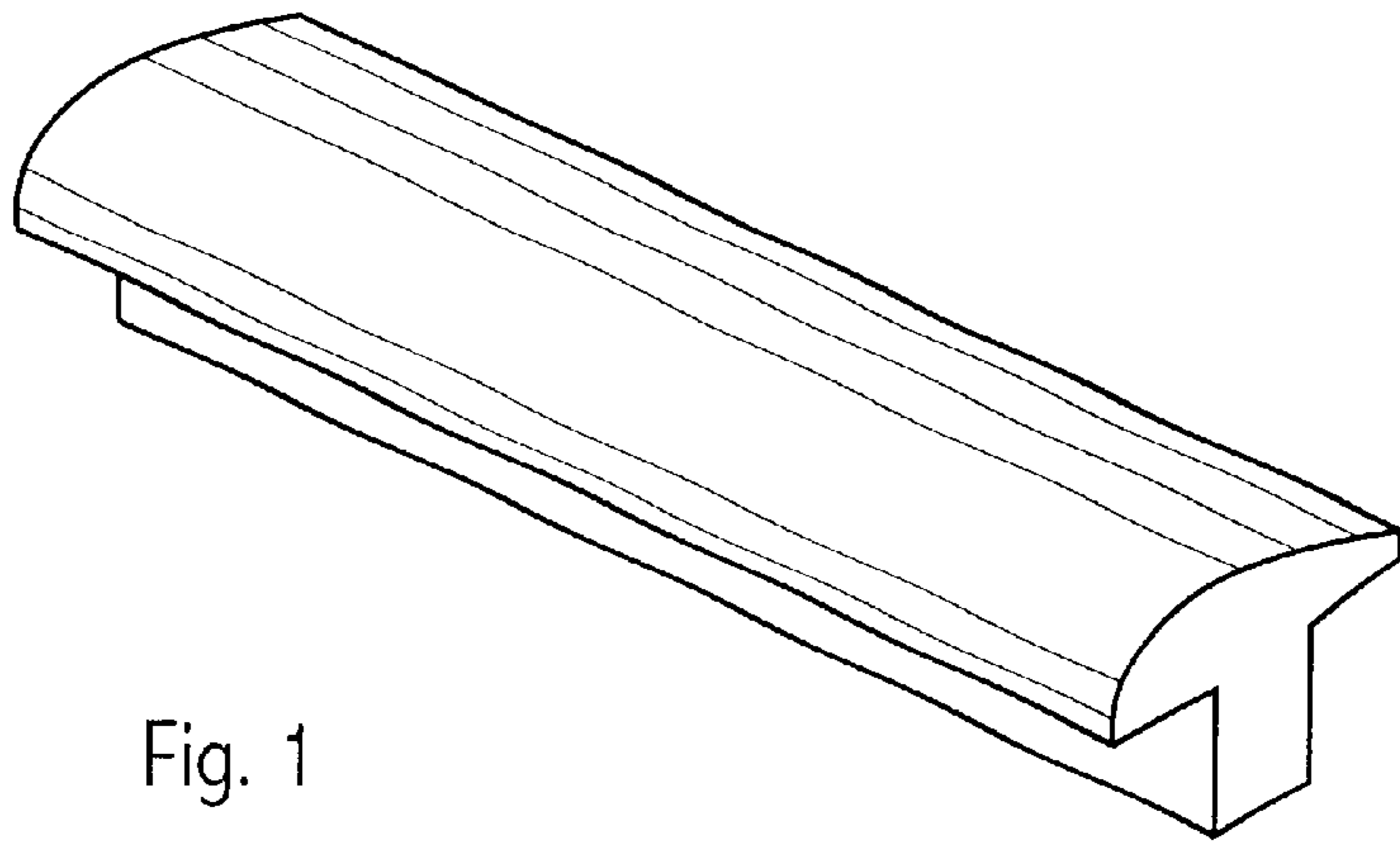

Fig. 1

Fig. 2

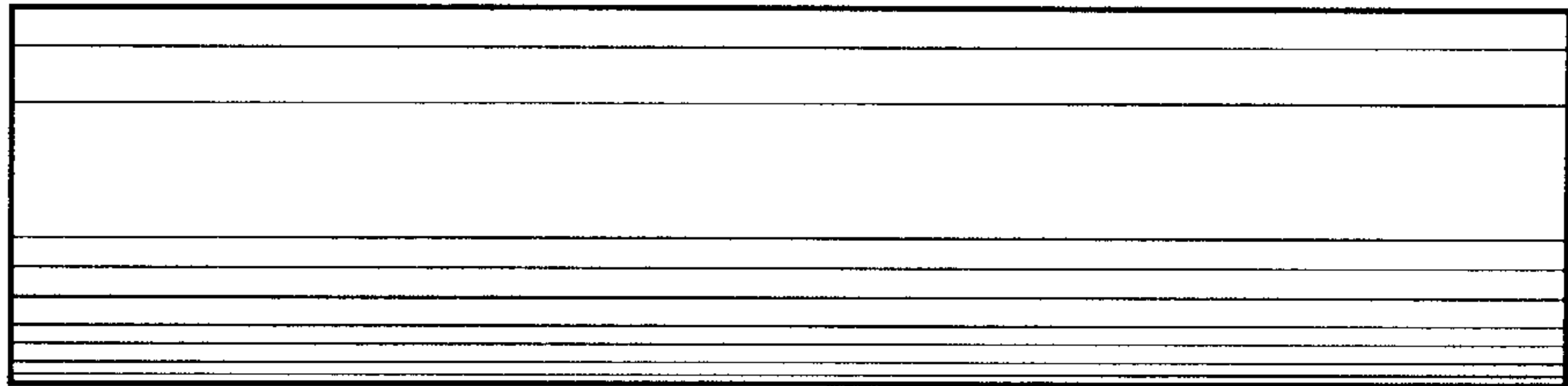

Fig. 3

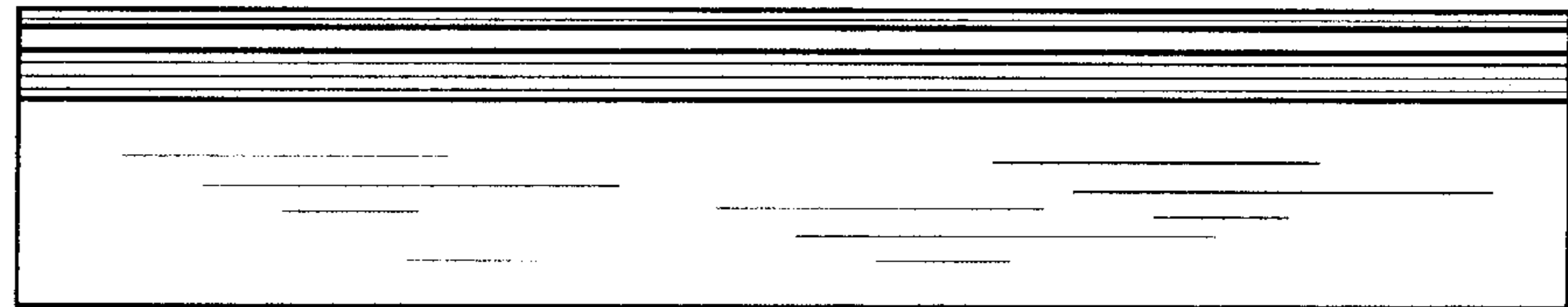

Fig. 4

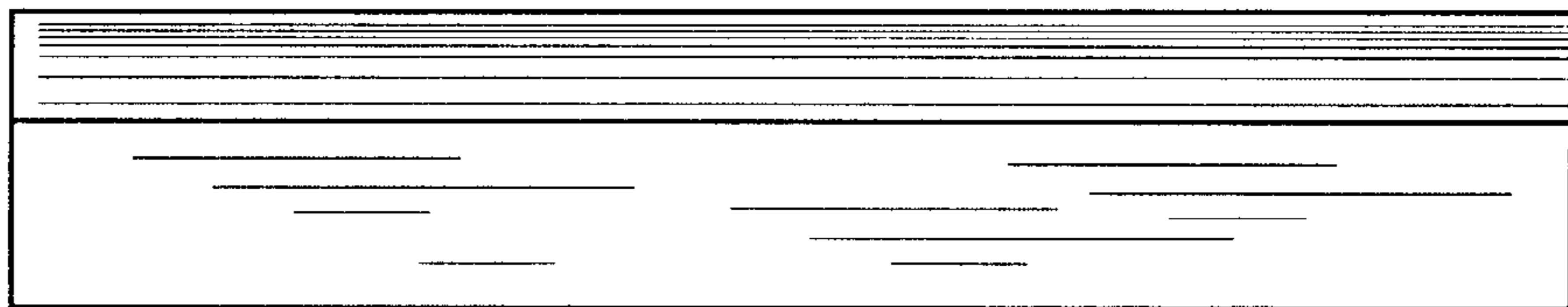

Fig. 5

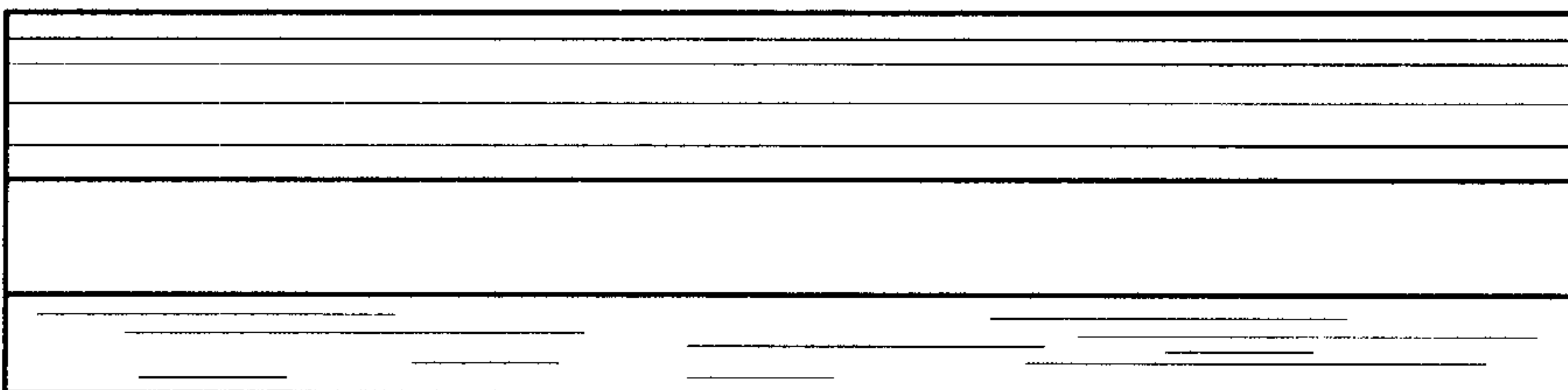

Fig. 6

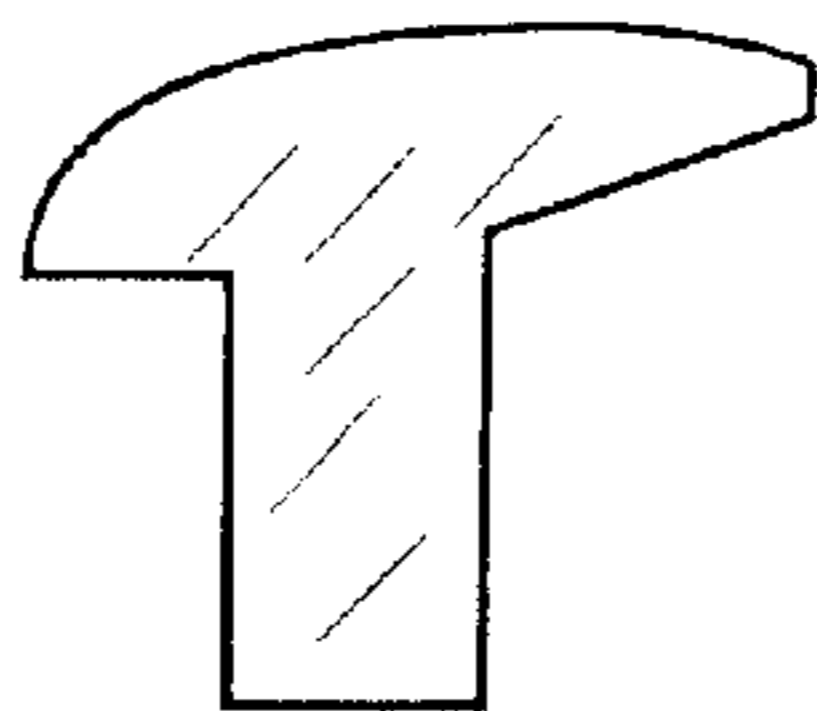
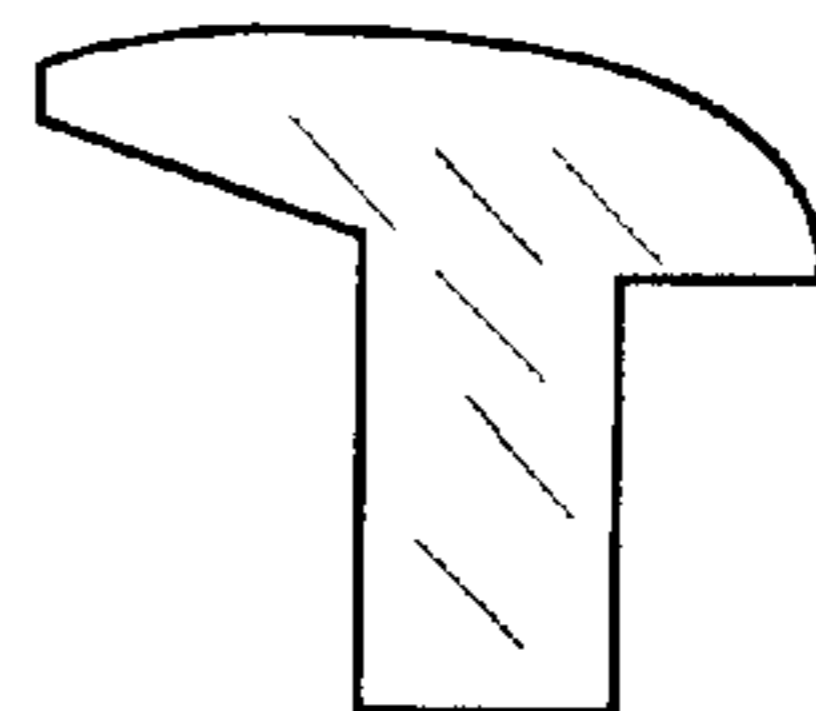

Fig. 7



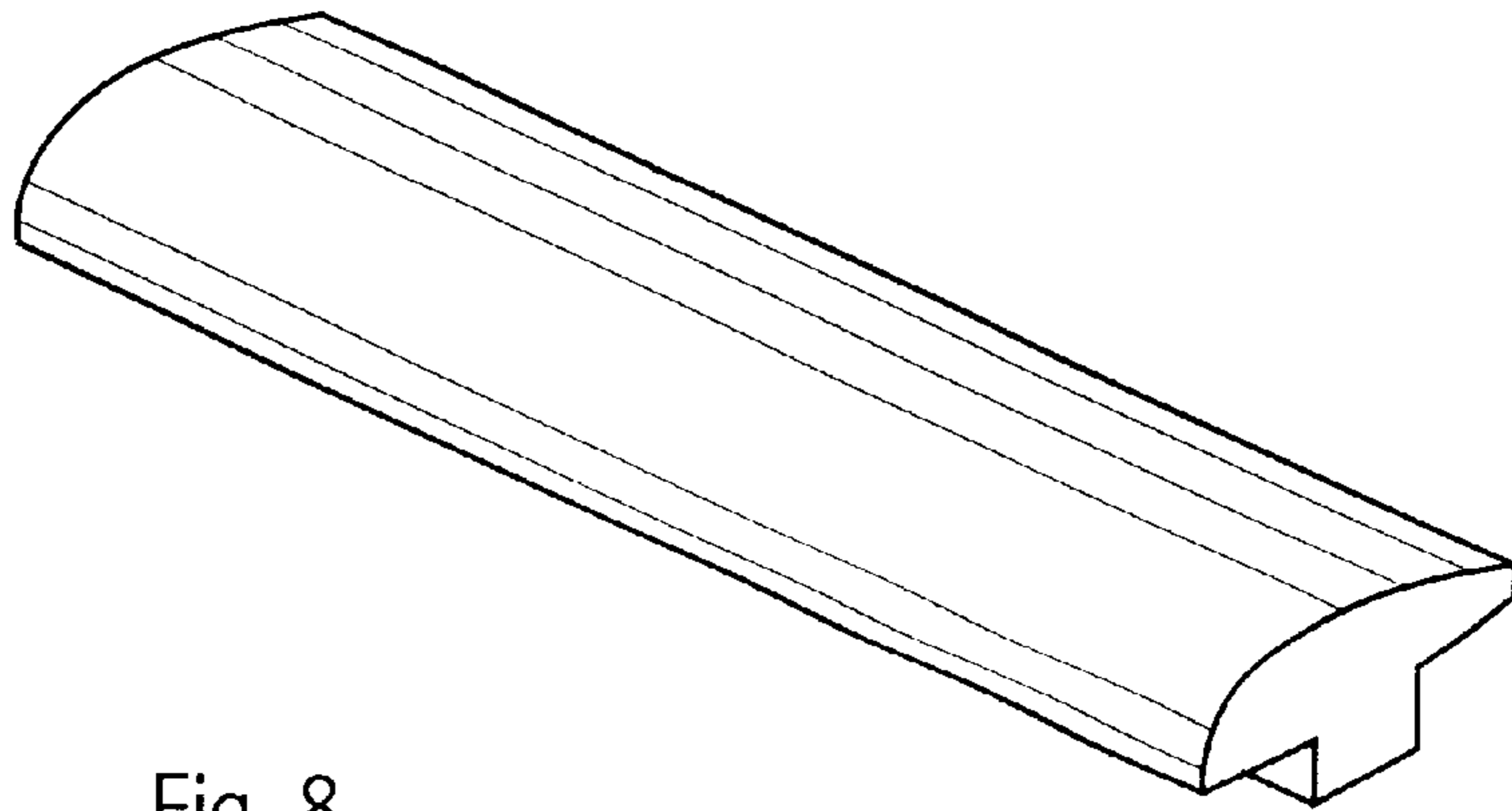

Fig. 8

Fig. 9

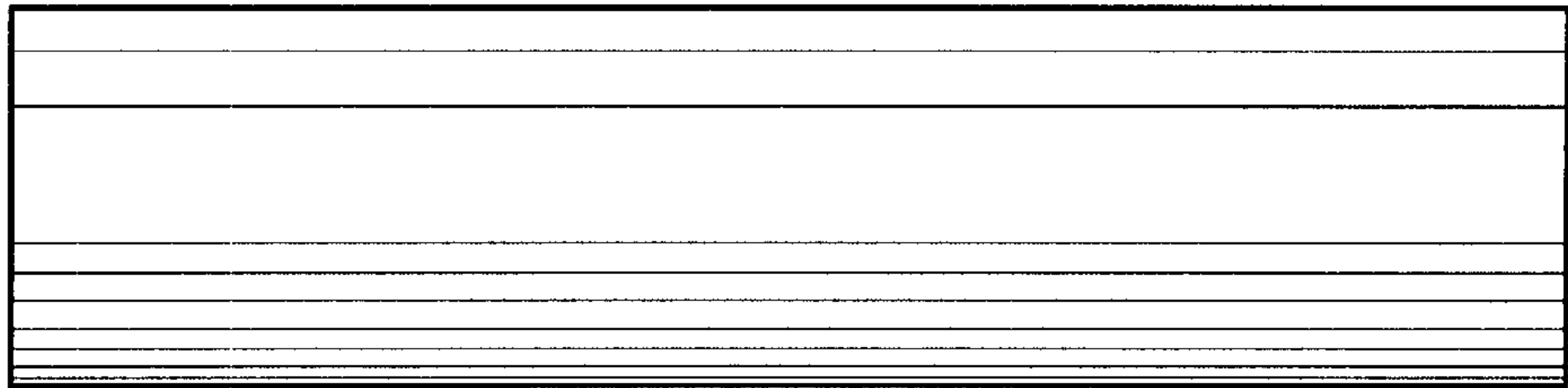

Fig. 10

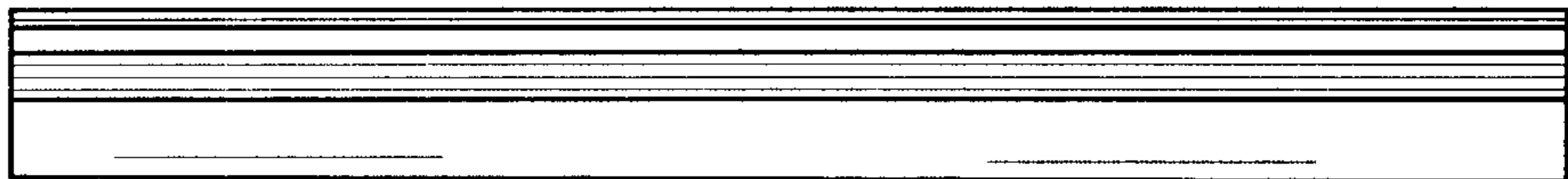

Fig. 11

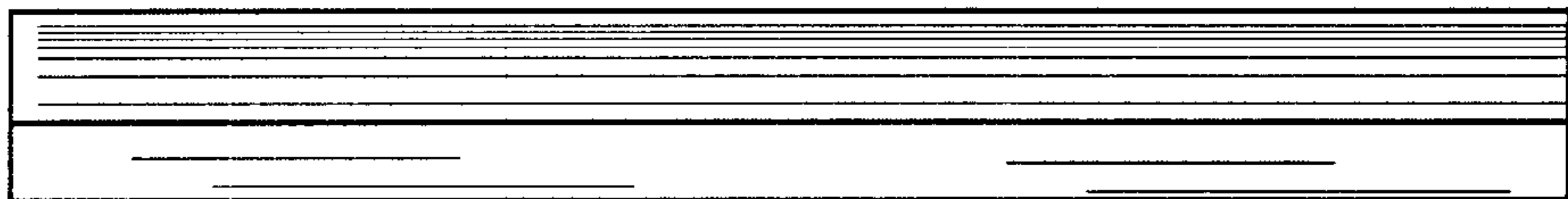

Fig. 12

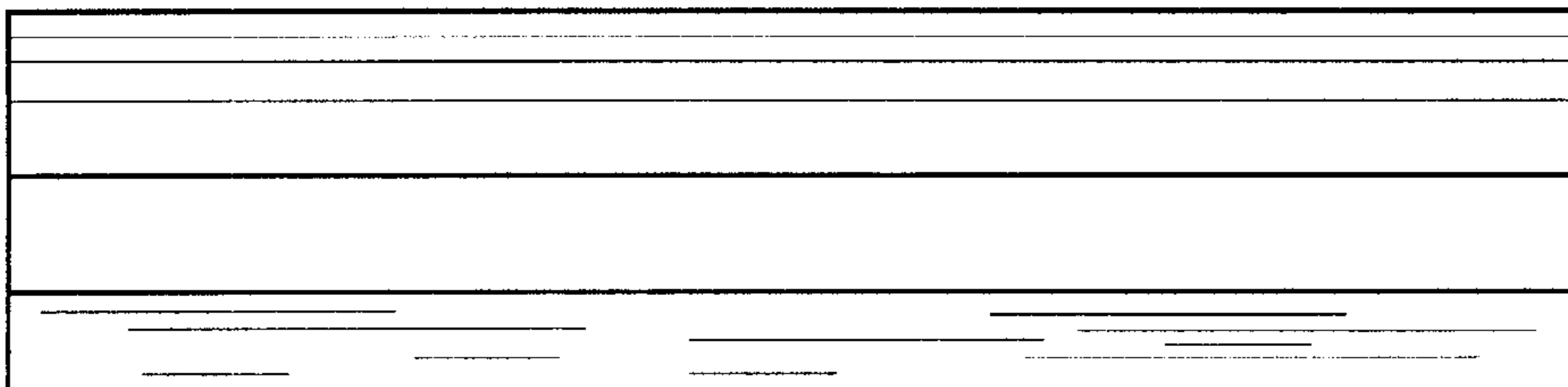

Fig. 13

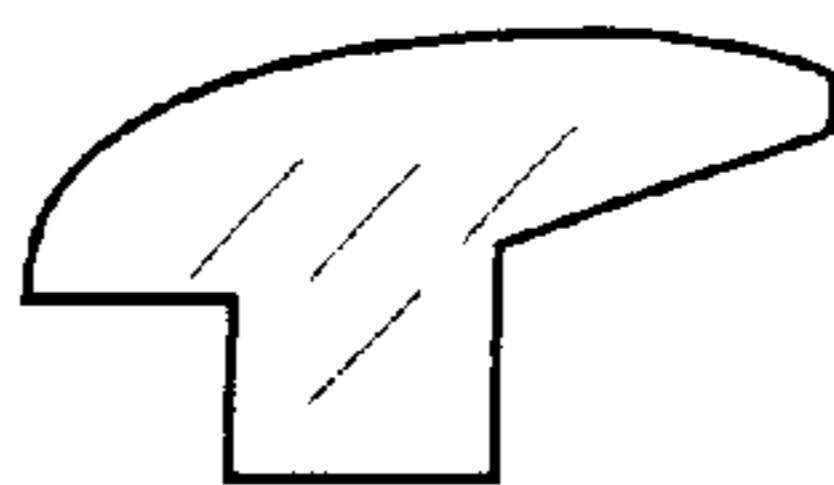

Fig. 14

