



US00D464083S

(12) **United States Design Patent**
Yoon

(10) **Patent No.:** **US D464,083 S**

(45) **Date of Patent:** **** Oct. 8, 2002**

(54) **BALL-POINT PEN**

(75) **Inventor:** **Chang Bong Yoon, Seoul (KR)**

(73) **Assignee:** **Dong-A Pencil Co., Ltd., Seoul (KR)**

(**) **Term:** **14 Years**

(21) **Appl. No.:** **29/149,055**

(22) **Filed:** **Oct. 3, 2001**

(51) **LOC (7) Cl.** **19-06**

(52) **U.S. Cl.** **D19/51; D19/56; D19/55**

(58) **Field of Search** **D19/35, 36, 41-51,**
D19/53-58, 81-85; 401/6, 7, 88, 99-101,
103-106, 107-110, 111-117, 209

(56) **References Cited**

U.S. PATENT DOCUMENTS

3,130,712 A	4/1964	Kahn et al.	
D340,476 S	10/1993	Hiromori	
D350,771 S	9/1994	Kettmeir	
D359,757 S	6/1995	Inami et al.	
D359,758 S	6/1995	Inami	
D364,892 S	12/1995	Lin	
D366,497 S	1/1996	Otake	
D366,498 S	1/1996	Abe et al.	
D374,893 S	* 10/1996	Yazawa D19/51
D389,863 S	1/1998	Nguyen	

D401,624 S	* 11/1998	Sakuno D19/51
D404,070 S	* 1/1999	Hasegawa D19/51
D404,425 S	* 1/1999	Suzuki D19/43
D411,858 S	* 7/1999	Katami D19/51
D451,545 S	* 12/2001	Tsuchikura D19/36
D453,790 S	* 2/2002	Tsuchikura D19/36

* cited by examiner

Primary Examiner—Martie K. Holtje

(74) *Attorney, Agent, or Firm*—Birch, Stewart, Kolasch & Birch, LLP

(57) **CLAIM**

The ornamental design for a ball-point pen, as shown and described.

DESCRIPTION

FIG. 1 is a front elevational view of a ball-point pen, showing my new design;
 FIG. 2 is a rear elevational view thereof;
 FIG. 3 is a side elevational view taken from the left side of FIG. 1, the right side elevational view being a mirror image thereof;
 FIG. 4 is a top plan view thereof;
 FIG. 5 is a bottom plan view thereof; and,
 FIG. 6 is a perspective view thereof.

1 Claim, 1 Drawing Sheet

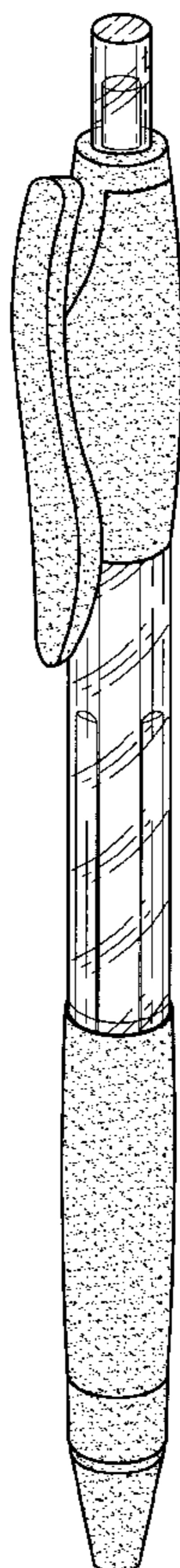

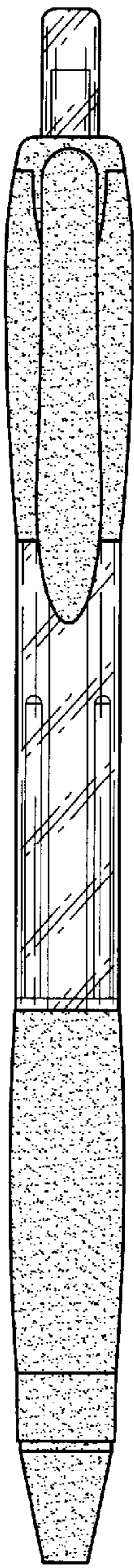

FIG. 1

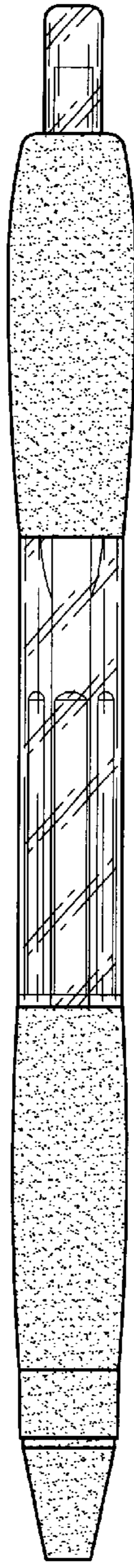

FIG. 2

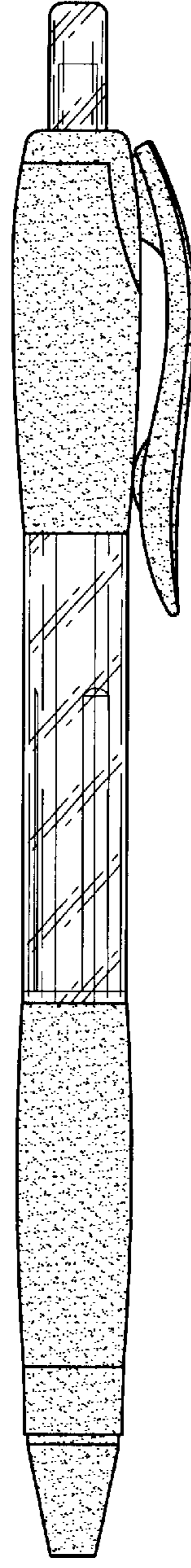

FIG. 3

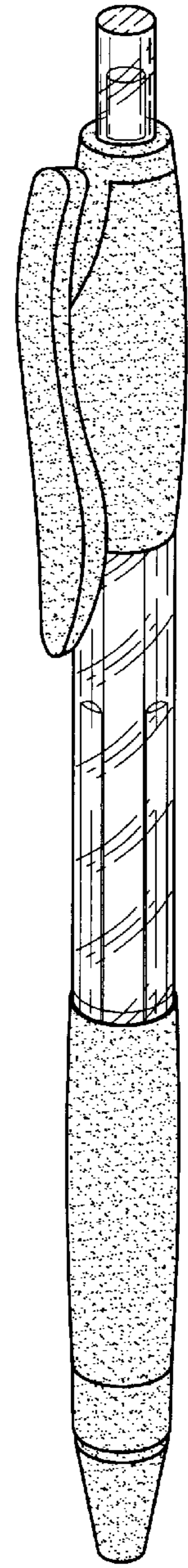

FIG. 6

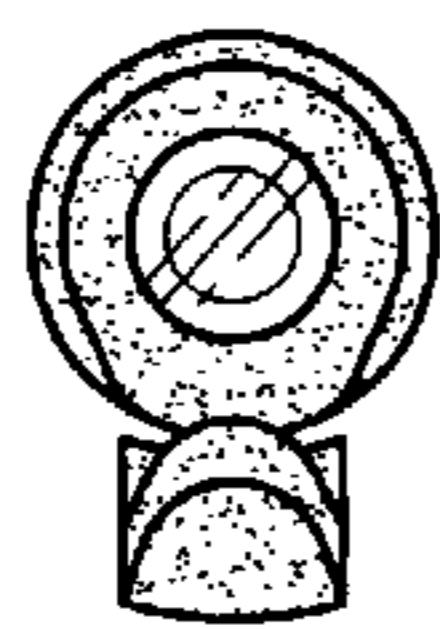

FIG. 4

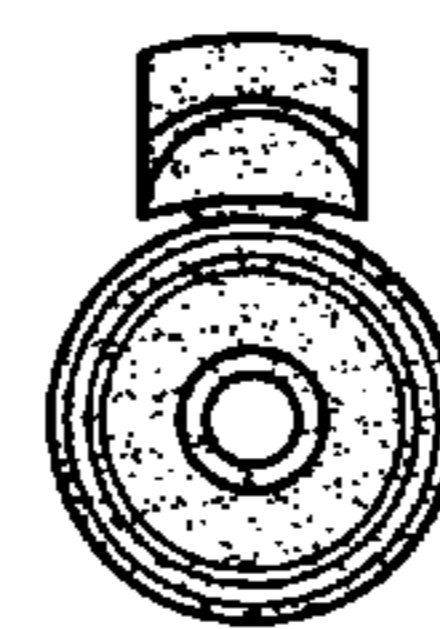

FIG. 5